

Barbados lässt sich auch spiegelverkehrt aufbauen.
Barbados can be built mirrored.

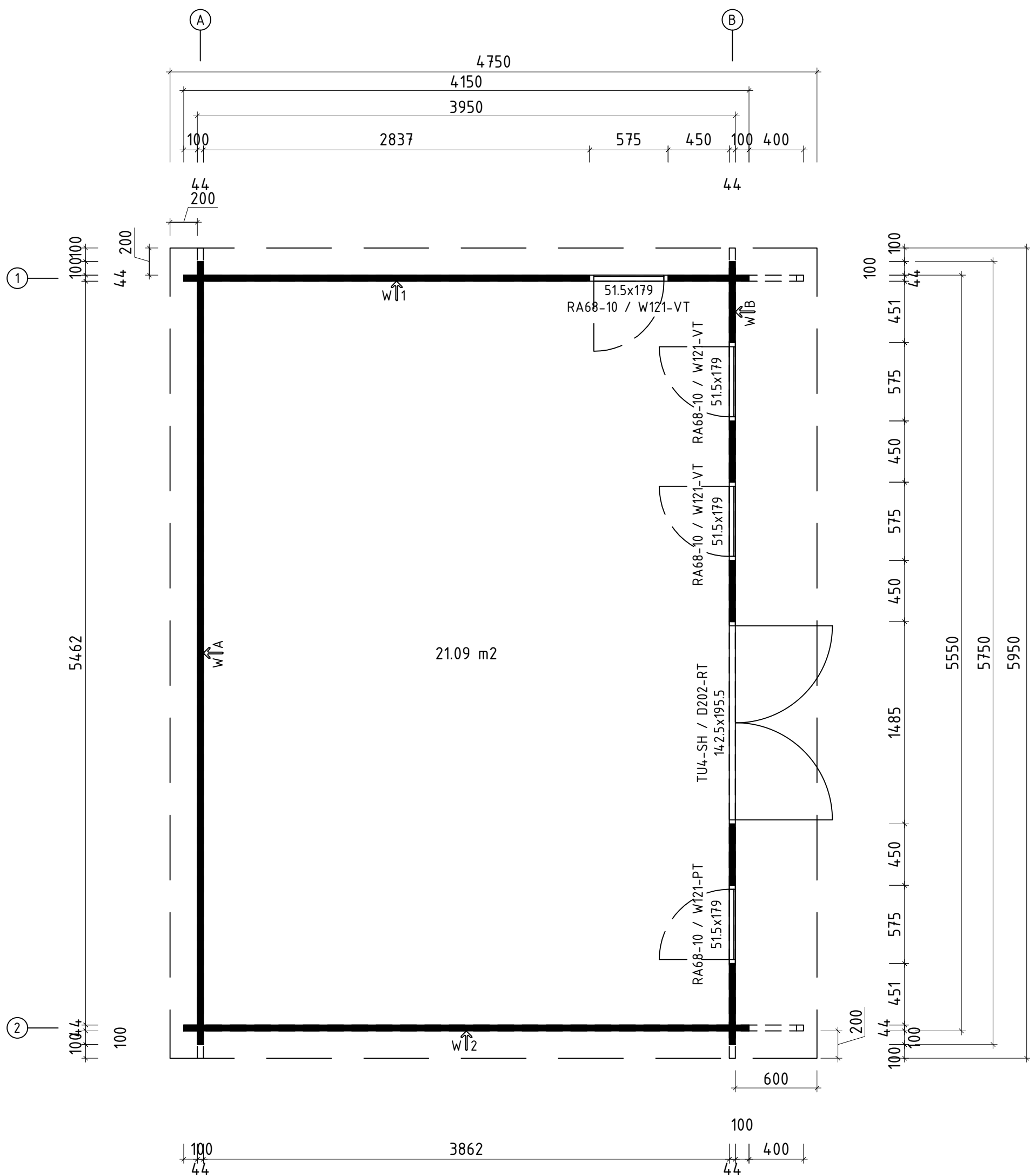









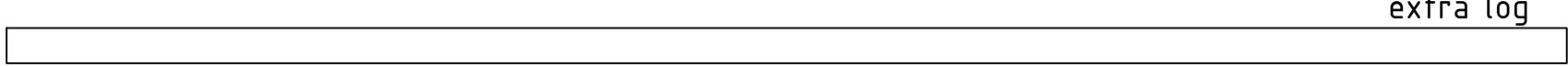
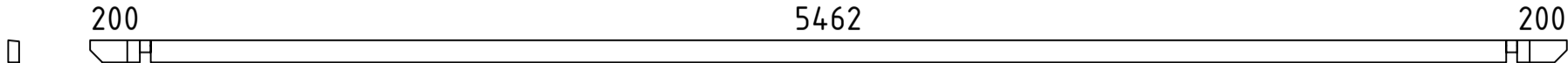
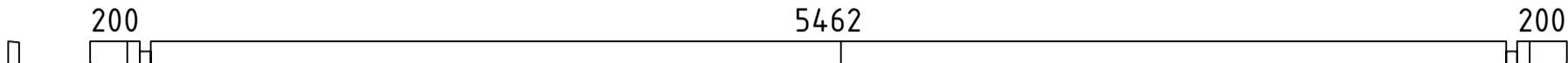
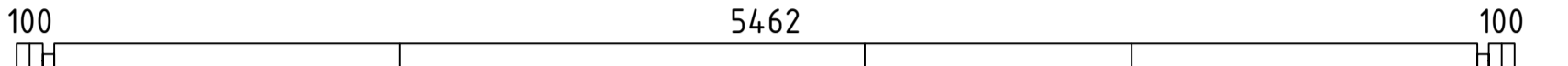
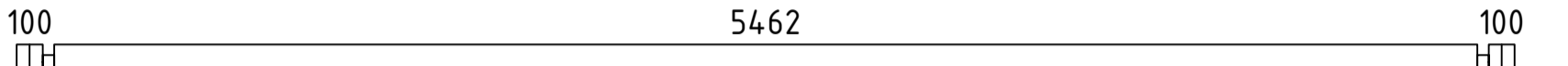
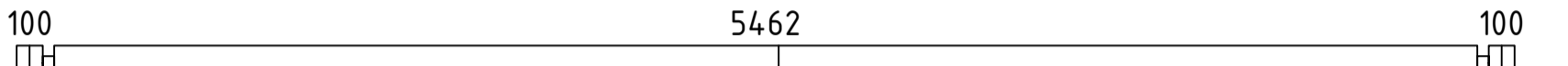
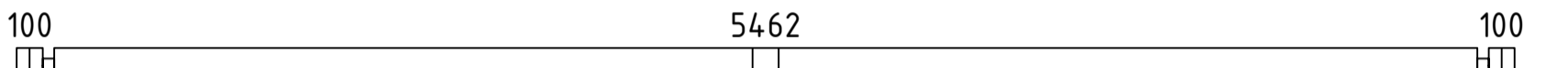



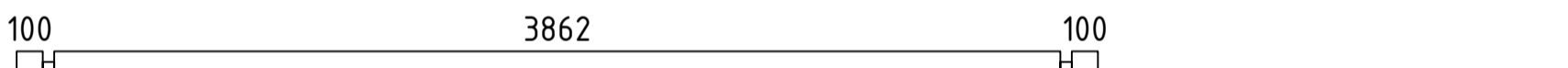

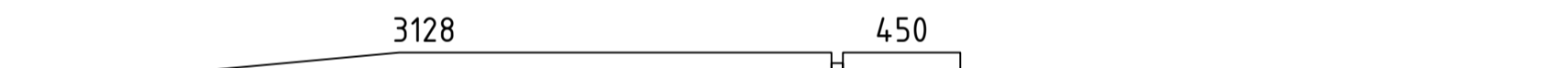



| | | | |
|-------------------|------------------------|------------|------------|
| Name | Barbados 415x575+SD_44 | | |
| Zeichnung/Drawing | 3D | | |
| Profil/Profile | 4.4x13.5 | Datum/Date | 02.03.2021 |







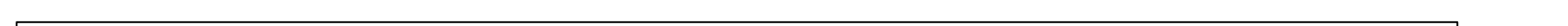



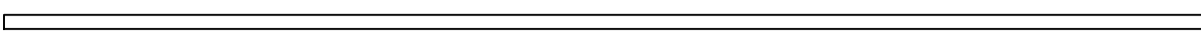
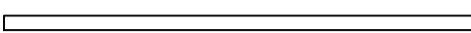
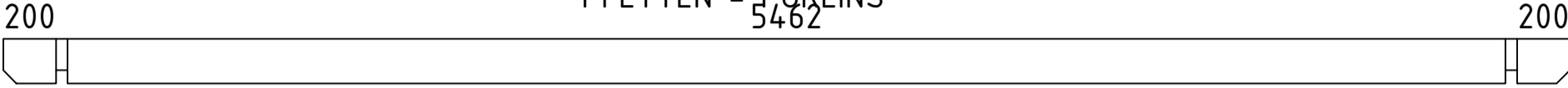
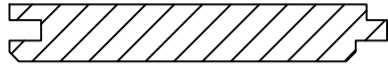
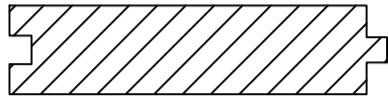
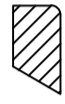
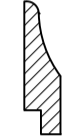
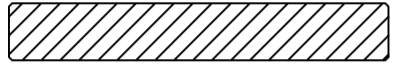

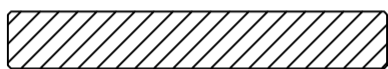
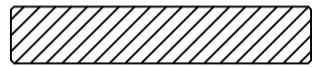
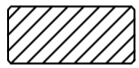

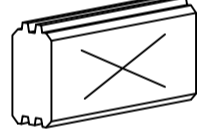
Q5 - Qualitätsklasse für Fenster und Türen/
Quality class for windows and doors

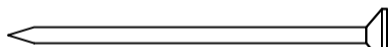
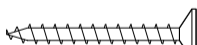
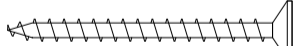
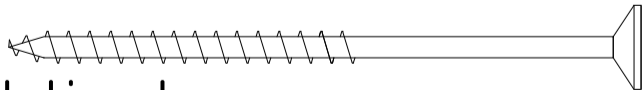
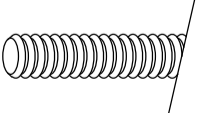
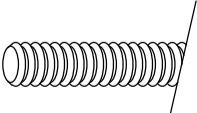
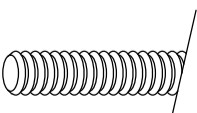
* Fenster und Türen sind ohne Sprossen/
Windows and doors are without muntins

| | | | |
|-------------------|------------------------|------------|------------|
| Name | Barbados 415x575+SD_44 | | |
| Zeichnung/Drawing | Grundplan, Plan | | |
| Profil/Profile | 4.4x13.5 | Datum/Date | 02.03.2021 |

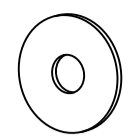
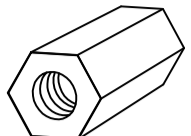
| Pos | Teileliste/Specification Barbados 415x575+SD_44 | Stck. Pcs. | Profil Profile (mm) | Länge Length (mm) |
|-----|--|---------------|---------------------------|-------------------------|
| | Achtung! Die Giebelbohlen können teilweise schon vormontiert sein! Bitte beachten - diese erscheinen nicht ganz so wie in der Teileliste beschrieben. | | | |
| | Notice! The gable pieces can be partly pre-assembled! Please notice - those differ from the description given in the specification list. | | | |
| 000 |  | 1 | 44x135 | 5950 |
| 001 |  | 1 | 44x89 | 5950 |
| 002 |  | 1 | 44x135 | 5950 |
| 003 |  | 1 | 44x135 | 5750 |
| 004 |  | 1 | 44x135 | 5750 |
| 005 |  | 10 | 44x135 | 5750 |
| 006 |  | 4 | 44x135 | 5750 |
| 007 |  | 1 | 44x135 | 4150 |
| 008 |  | 1 | 44x135 | 4150 |
| 009 |  | 2 | 44x68 | 4150 |
| 010 |  | 14 | 44x135 | 4150 |
| 011 |  | 1 | 44x135 | 4150 |
| 012 |  | 2 | 44x135 | 3622 |
| 013 |  | 13 | 44x135 | 2981 |
| 014 |  | 1 | 44x135 | 2645 |
| 015 |  | 2 | 44x135 | 2203 |
| 016 |  | 1 | 44x135 | 1620 |
| 017 |  | 2 | 44x68 | 734 |
| 018 |  | 28 | 44x135 | 595 |
| 019 |  | 6 | 44x135 | 594 |
| 020 |  | 4 | 44x135 | 594 |
| 021 |  | 3 | 44x135 | 594 |
| 022 |  | 30 | 44x135 | 450 |
| 023 |  | 12 | 44x135 | 450 |
| FH1 | FUNDAMENTHOLZ (imprägniert) - FOUNDATION BEAM (impregnated)  | 2 | 70x45 | 5530 |
| FH2 | FUNDAMENTHOLZ (imprägniert) - FOUNDATION BEAM (impregnated)  | 6 | 70x45 | 5390 |

| Pos | Teileliste/Specification Barbados 415x575+SD_44 | | Stck. Pcs. | Profil Profile (mm) | Länge Length (mm) |
|---------------|---|--|---|---------------------------|-------------------------|
| FH4 | FUNDAMENTHOLZ (imprägniert) - FOUNDATION BEAM (impregnated)  | | 2 | 70x45 | 3790 |
| FH3 | FUNDAMENTHOLZ (imprägniert) - FOUNDATION BEAM (impregnated)  | | 1 | 70x45 | 1485 |
| PF1 | PFETTEN - PURLINS 200  200 | | 5 | 58x170 | 5950 |
| | DACHBRETTER - ROOF BOARDS |  | 53+1 | 113x18 | 4770 |
| | FUSSBODENBRETTER - FLOOR BOARDS |  | 49+1 | 113x28 | 3855 |
| | ABDECKLEISTEN - COVER STRIPS |  ✓ | | 15x28 | 22.0 lfm/rm |
| | FUSSBODENLEISTEN - FLOOR STRIPS |  ✓ | | 14x55 | 19.0 lfm/rm |
| G02-1 | GIEBELBRETTER - GABLE BOARDS 18x120 |  ✓ | 2 | 18x120 | 4790 |
| G05-1 | GIEBELDECKLEISTEN - GABLE COVER STRIPS 18x40 |  ✓ | 4 | 18x40 | 2385 |
| T02-1 | TRAUFBRETTER - EAVES BOARDS 18x120 |  | 1 | 18x120 | 5986 |
| T01-1 | TRAUFBRETTER - EAVES BOARDS 18x95 |  | 1 | 18x95 | 5950 |
| T04-1 | TRAUFENDECKLEISTEN - EAVES COVER STRIPS 18x40 |  ✓ | | 18x40 | 6.0 lfm/rm |
| T06-1 | TRAUFENLEISTEN - EAVES STRIPS 18x40 |  ✓ | | 18x40 | 12.0 lfm/rm |
| SH | SCHLAGHÖLZER - MOUNTING PIECES |  | 3 | | |
| NG04 | NÄGEL - NAILS 2.5x50 | Dachbretter - Roof boards |  | 742 | |
| NG05 | NÄGEL - NAILS 2.5x60 | Fussbodenbretter - Floor boards |  | 784 | |
| SR32 | Schrauben - Screws 3.0x30 | Abdeckleiste - Cover strips Fussbodenleiste - Floor strips Traufenleiste - Eaves strips 40x18 Traufendeckleiste - Eaves cover strips Giebeldeckleiste - Gable cover strips |  | 140 | |
| SR37 | Schrauben - Screws 3.5x45 | Traufenbretter - Eaves boards Giebelbretter - Gable boards Türleisten - Door/Window strips |  | 165 | |
| SR57 | Schrauben - Screws 5.0x100 | Fundamenthölzer - Foundation beams |  | 44 | |
| KL1 | Gewindestange - Threaded Rod M8 |  | 4 | | 2000 |
| KL2 | Gewindestange - Threaded Rod M8 |  | 2 | | 414 |
| KL3 | Gewindestange - Threaded Rod M8 |  | 2 | | 55 |
| KV M UT M8 | Mutter - Nut M8 |  | 8 | | |
| Kood | Barbados 415x575+SD_44 | Materjal | File | Leht | 2/3 |

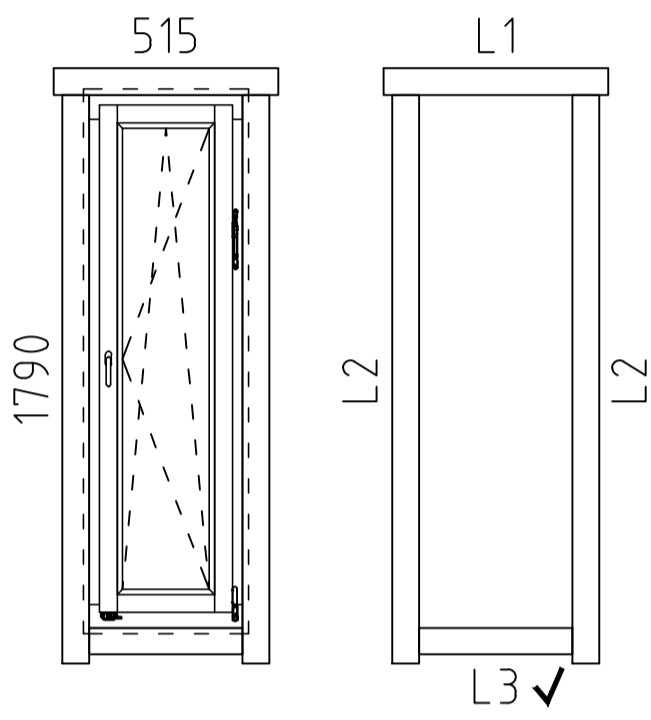
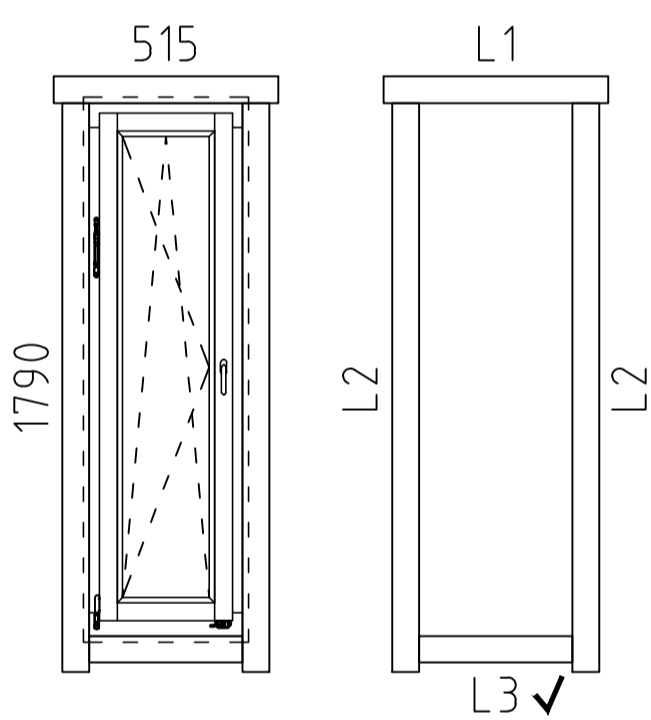
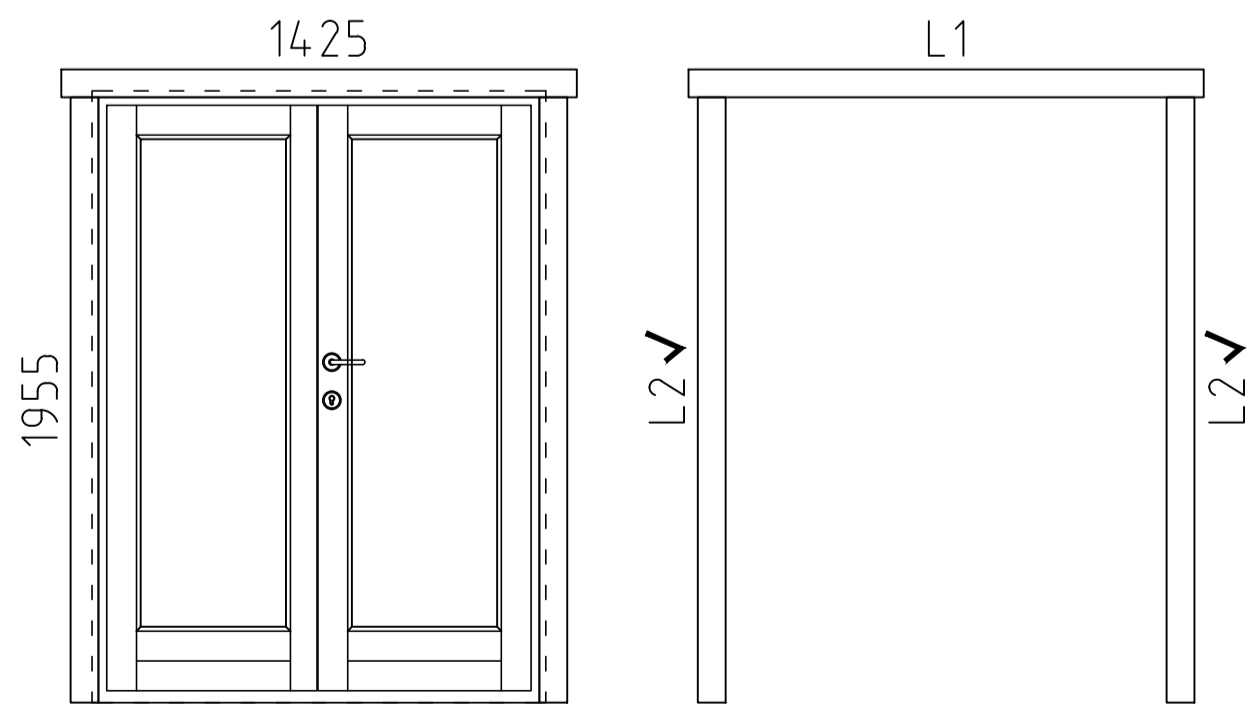
| Pos | Teileliste/Specification Barbados 415x575+SD_44 | | Stck. Pcs. | Profil Profile (mm) | Länge Length (mm) |
|----------------------|--|---|---------------|---------------------------|-------------------------|
| KV S EIB M8X25 | U-Scheibe - Washer M8 Ø25 |  | 8 | | |
| KV MU TJ M8 | Befestigungsmutter - Fixing nut M8 |  | 4 | | |
| ML1 | Metallstange - Metal bar |  | 10 | D10 | 900 |
| ML2 | Metallstange - Metal bar |  | 3 | D10 | 770 |
| ML3 | Metallstange - Metal bar |  | 2 | D10 | 630 |
| | FENSTER/WINDOW Q5 | W5-S44P-0XT-05151790 | 1 | | |
| |  <p>515 1790 L1 L2 L3 ✓</p> <p>RA68-10 / W121-PT</p> <p>L1 18x90 L=755mm 2x L2 18x90 L=1910mm 4x L3 18x90 L=515mm 2x ✓</p> | | | | |
| | FENSTER/WINDOW Q5 | W5-S44V-0XT-05151790 | 3 | | |
| |  <p>515 1790 L1 L2 L3 ✓</p> <p>RA68-10 / W121-VT</p> <p>L1 18x90 L=755mm 2x L2 18x90 L=1910mm 4x L3 18x90 L=515mm 2x ✓</p> | | | | |
| | TÜR/DOOR Q5 | D5-D44R-0XT-14251955 | 1 | | |
| |  <p>1425 1955 L1 L2 ✓ L2 ✓</p> <p>TU4-SH / D202-RT</p> <p>L1 18x90 L=1665mm 2x L2 18x90 L=1955mm 4x ✓</p> <p>DIN rechts / right handed</p> | | | | |
| | ✓ - Bitte selber anpassen (falls nötig)! / Cut into length on site (if needed)! | | | | |
| Kood | Barbados 415x575+SD_44 | Materjal | File | Leht | 3/3 |

| | | | |
|---------|-------|---|-----------------------|
| Aken | Q4-Q6 | - | paigaldusjuhis |
| Window | Q4-Q6 | - | assembly instructions |
| Fenster | Q4-Q6 | - | Montageanleitung |

5-10mm

3.5x45

Lõika mõõtu
Cut to length
Absägen
- 10mm / -20mm

NB!

3.5x45

Vihmaliist / Rain strip / Wasserleiste

Q5-Q6

*Silikoon
*Silicon
*Silikon

*Vajumispilu
*Settling gap
*Senkungs spalt

ca 40-50mm

NB!

- Monteerida juhul kui ese on välja toodud maja spetsifikatsioonis!
- Install only if the item is listed in the house specification!
- Nur montieren wenn die Leiste in der Teileliste gezeigt ist!

Veeplekk / Window sill / Fensterbank

4,2x16

Ukse montaaž / Tür montage / Door assembly
(GH+ / SH)

4.5x90

4.5x90

5mm

3.5x45

Vihmaliist / Head flashing / Regenschutz

Silikoon
Silicon
Silikon

Vajumispilu
Settling gap
Senkungs spalt
40-50mm

NB!

- Monteerida juhul kui ese on välja toodud maja spetsifikatsioonis!
- Install only if the item is listed in the house specification!
- Nur montieren wenn die Leiste in der Teilleiste gezeigt ist!

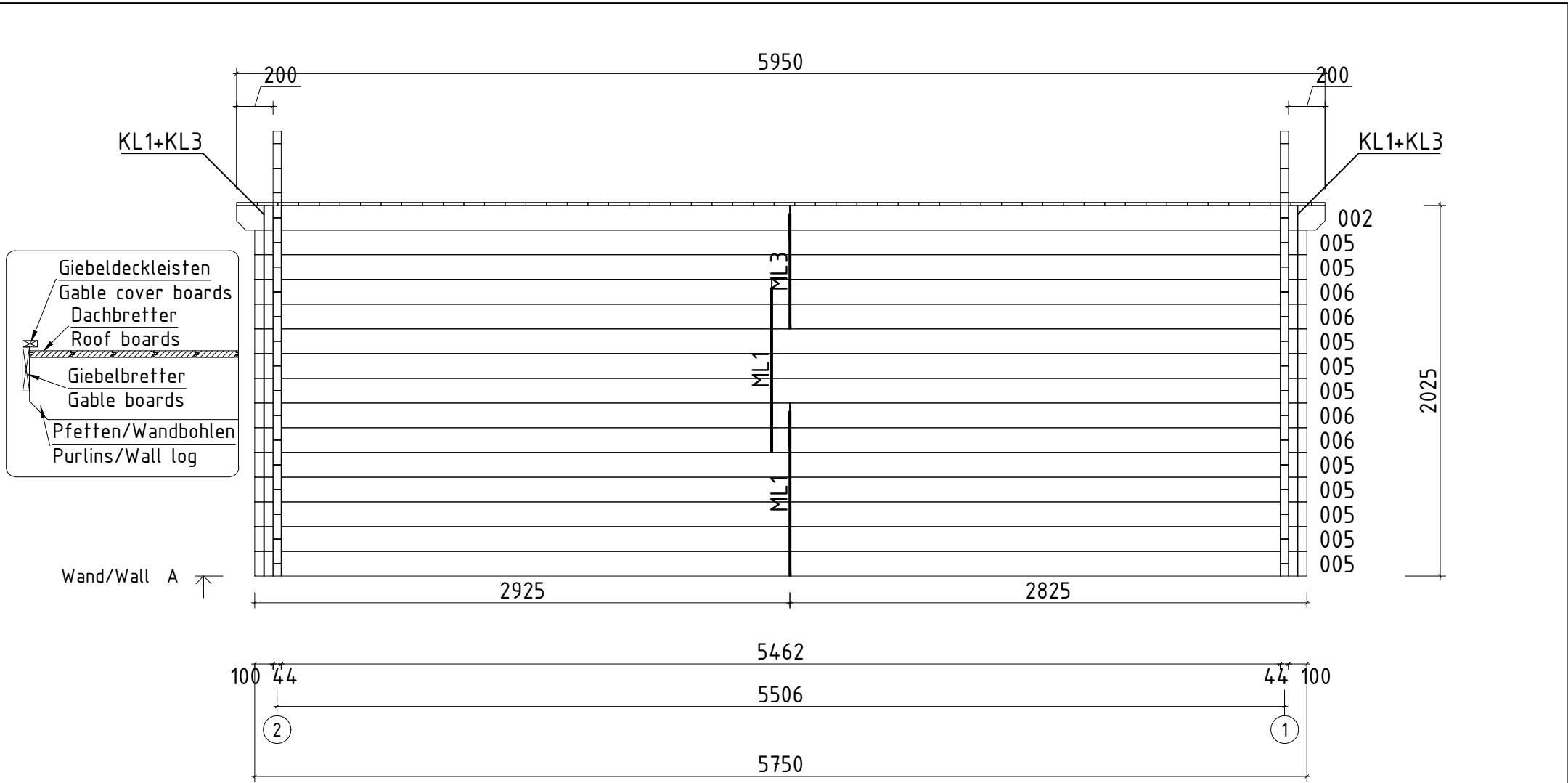

| | | | |
|-------------------|------------------------|------------|------------|
| Name | Barbados 415x575+SD_44 | | |
| Zeichnung/Drawing | WAND/WALL A | | |
| Profil/Profile | 4.4x13.5 | Datum/Date | 02.03.2021 |

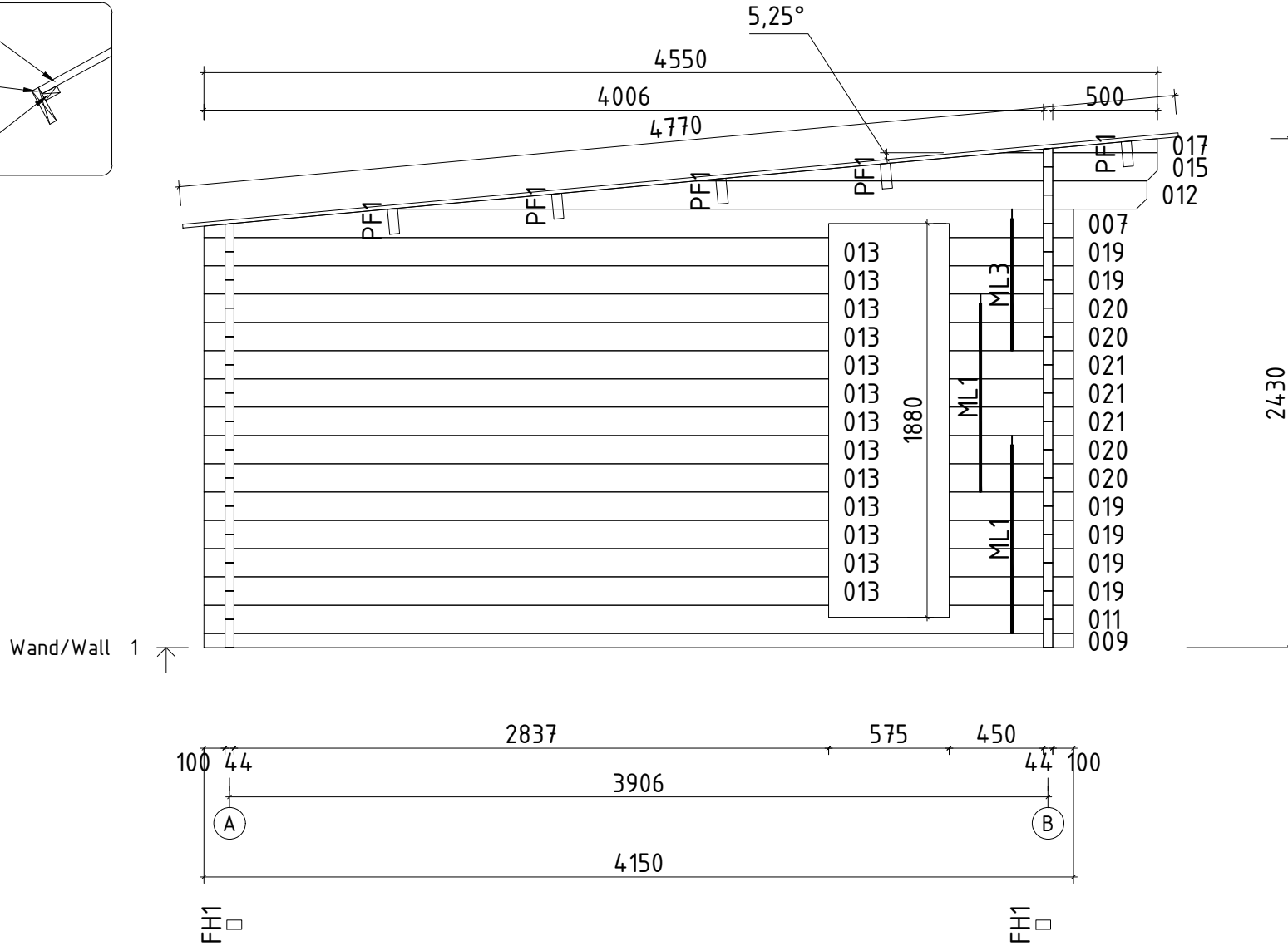
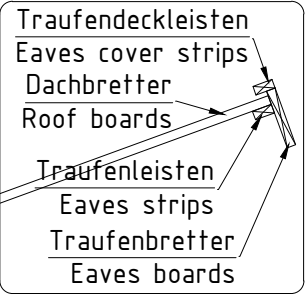
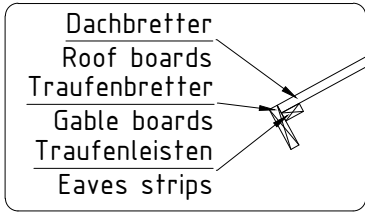

| | | | |
|-------------------|------------------------|------------|------------|
| Name | Barbados 415x575+SD_44 | | |
| Zeichnung/Drawing | WAND/WALL 1 | | |
| Profil/Profile | 4.4x13.5 | Datum/Date | 02.03.2021 |

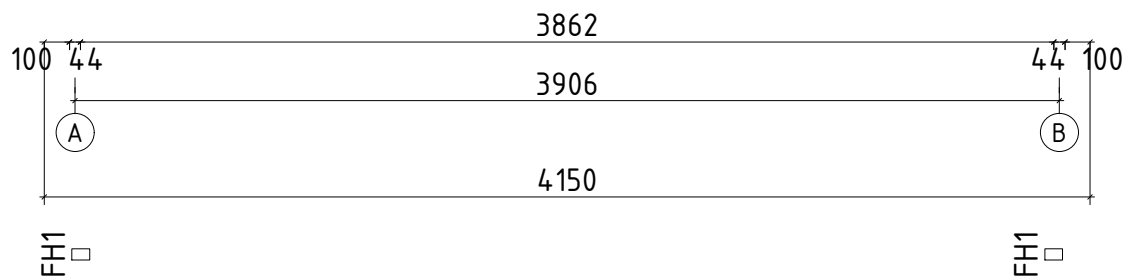
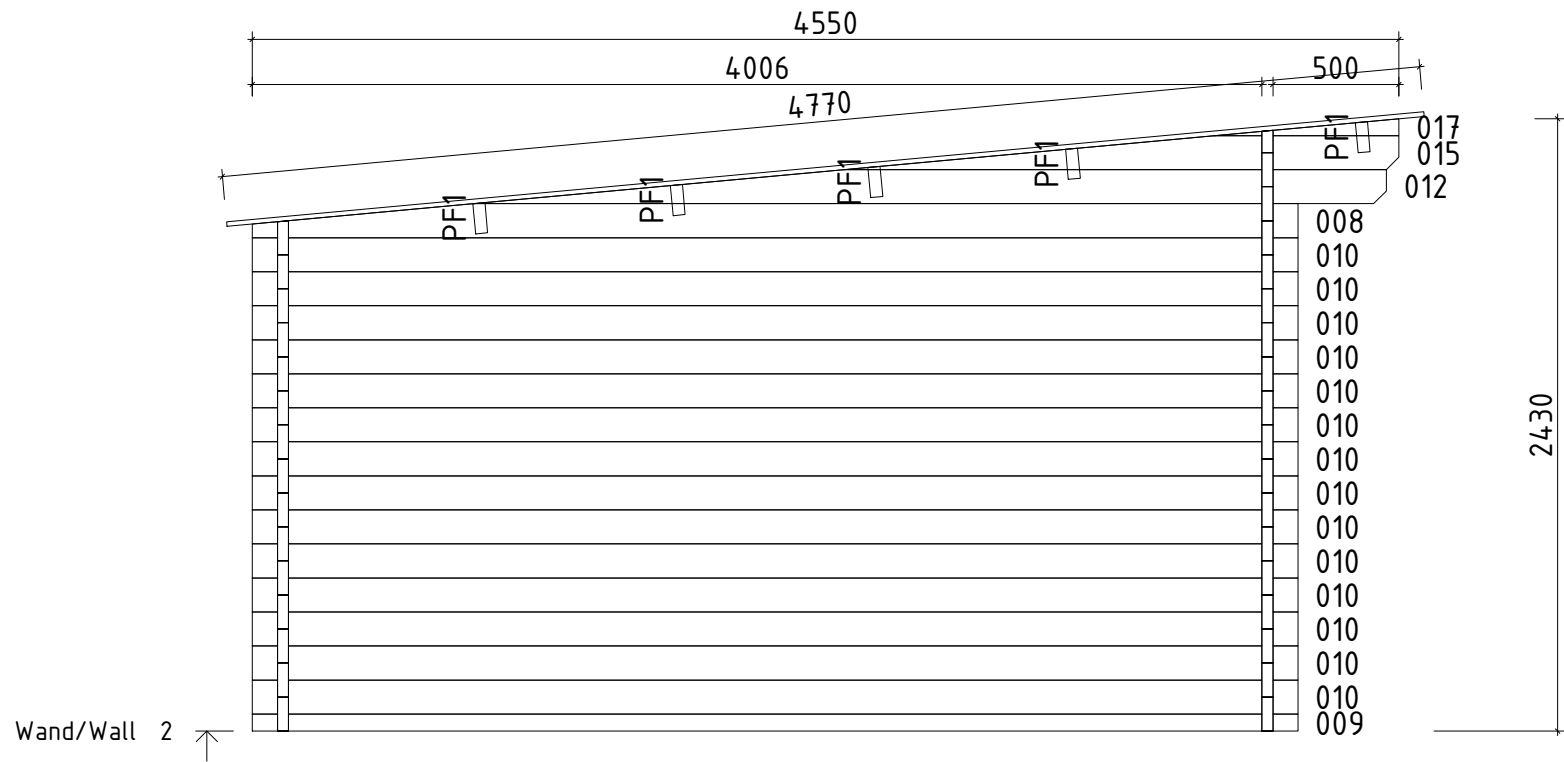

| | | | |
|-------------------|------------------------|------------|------------|
| Name | Barbados 415x575+SD_44 | | |
| Zeichnung/Drawing | WAND/WALL 2 | | |
| Profil/Profile | 4.4x13.5 | Datum/Date | 02.03.2021 |