

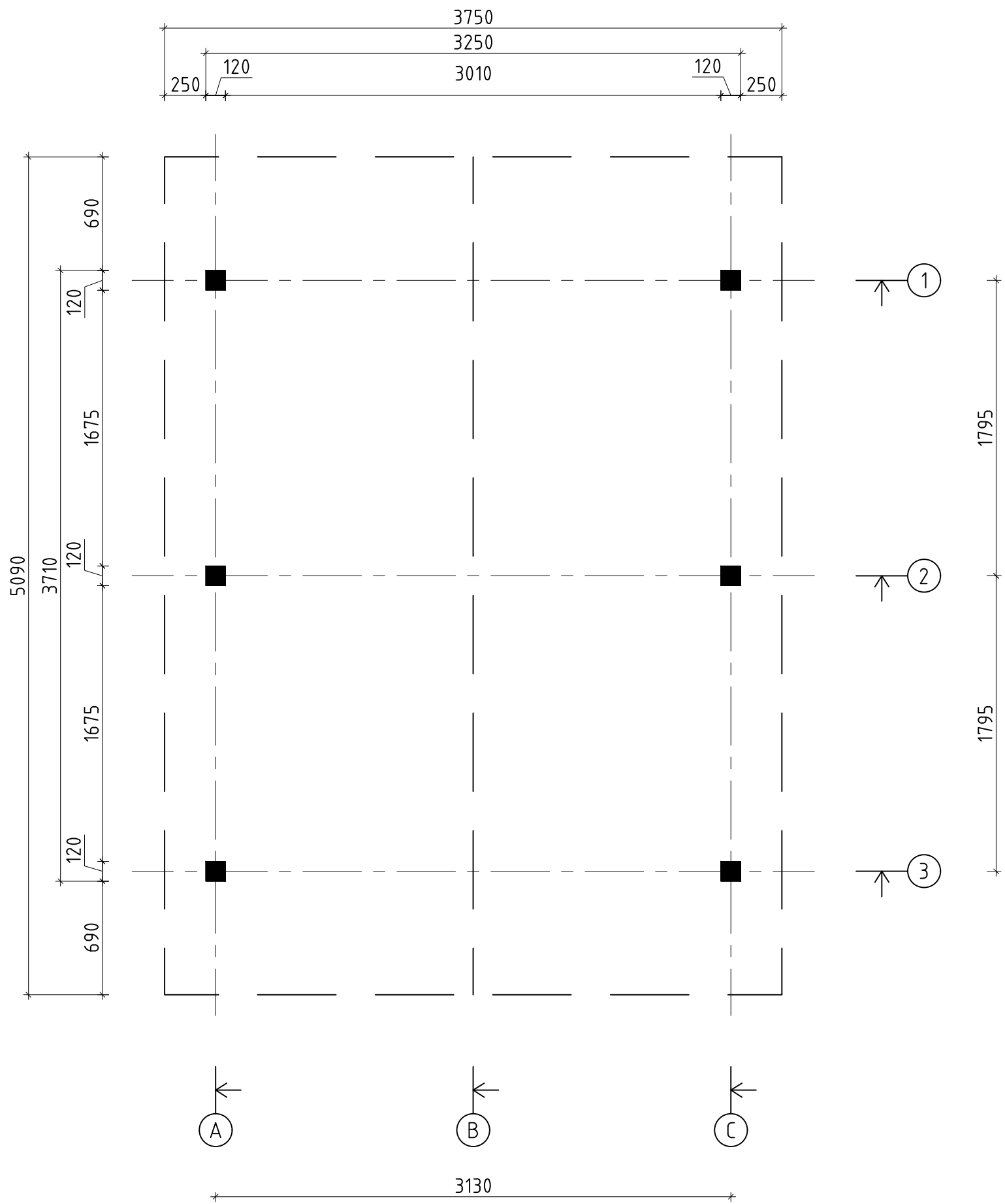

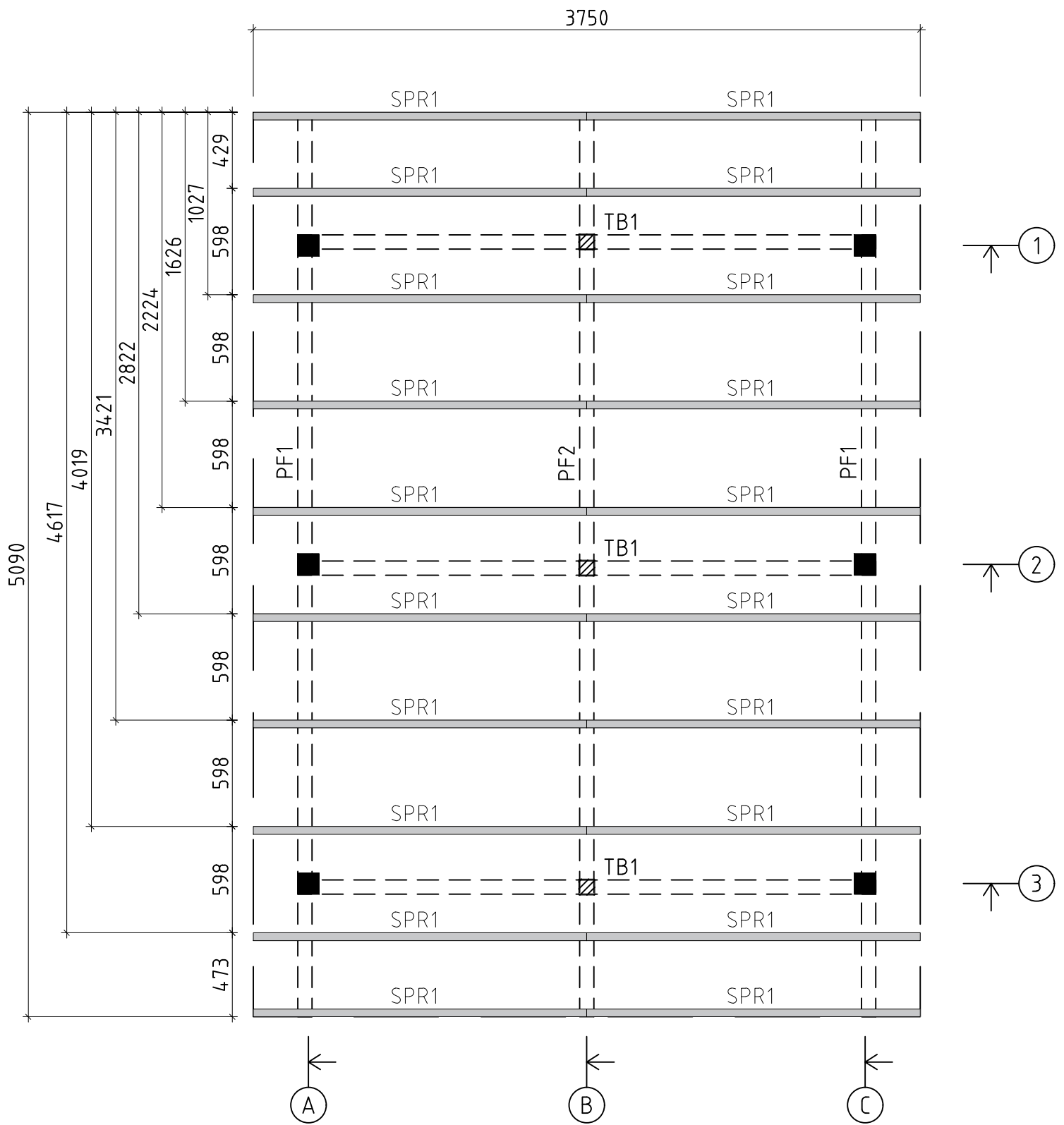





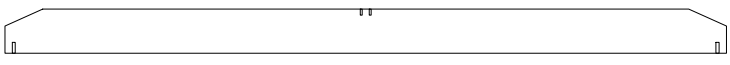
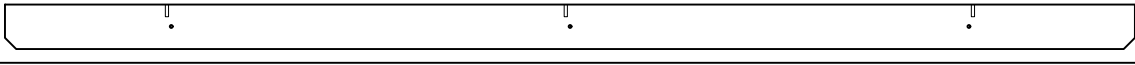
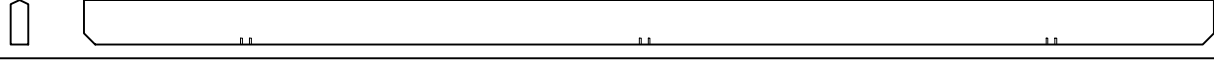
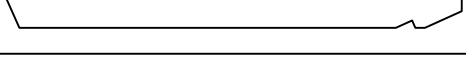

Name	Carport Henley 325x371		
Zeichnung/Drawing	3D		
Profil/Profile	Datum/Date	27.10.2021	

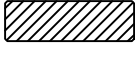
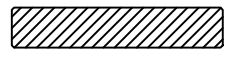
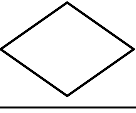
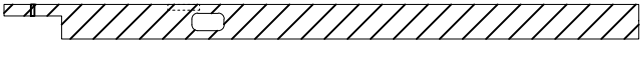
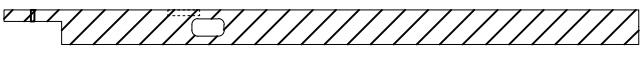
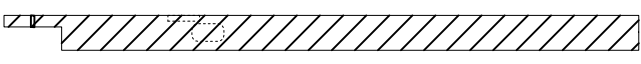
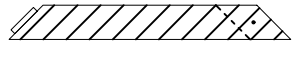
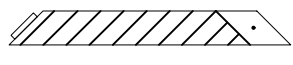
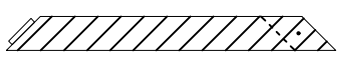
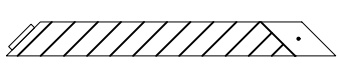

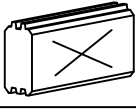

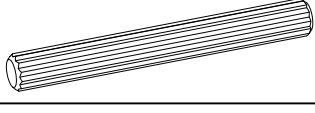
Name	Carport Henley 325x371	
Zeichnung/Drawing	Grundplan, Plan	
Profil/Profile	Datum/Date	27.10.2021



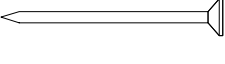
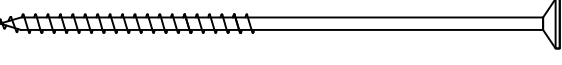

Name	Carport Henley 325x371		
Zeichnung/Drawing	Sparren, Rafters		
Profil/Profile		Datum/Date	27.10.2021

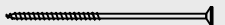
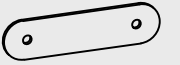

Pos	Teileliste/Specification Carport Henley 325x371		Stck Pcs.	Profil Profile (mm)	Länge Length (mm)
TB1	TRÄGEBALKE - SUPPORT BEAM 		3	80x200	3250
PF1	PFETTEN - PURLINS 		2	80x200	5090
PF2	PFETTEN - PURLINS 		1	80x200	5090
SPR1	SPARREN - RAFTERS 		20	44x145	2058
	DACHBRETTER - ROOF BOARDS 			135x18	192,0 lfm/rm
G02-1	GIEBELBRETTER - GABLE BOARDS 18x120 24,3° 	✓	4	18x120	2138
G06-1	GIEBELDECKLEISTEN - GABLE COVER STRIPS 18x58 	✓	4	18x58	2138
T01-1	TRAUFENBRETTER - EAVES BOARDS 18x95 		2	18x95	5090
GS	GIEBELSEGMENT - GABLE DIAMOND 		2		
TP120 -1	STÜTZPFOSTE - SUPPORT POST 120x120 		2	120x120	2200
TP120 -2	STÜTZPFOSTE - SUPPORT POST 120x120 		2	120x120	2200
TP120 -3	STÜTZPFOSTE - SUPPORT POST 120x120 		2	120x120	2200
TP120 -4	STÜTZPFOSTE - SUPPORT POST 120x120 		4	120x120	1000
TP120 -5	STÜTZPFOSTE - SUPPORT POST 120x120 		4	120x120	1000
TP120 -6	STÜTZPFOSTE - SUPPORT POST 120x120 		3	120x120	1141
TP120 -7	STÜTZPFOSTE - SUPPORT POST 120x120 		3	120x120	1141
TP90 -1	STÜTZPFOSTE - SUPPORT POST 90x90 		3	90x90	298
SH	SCHLAGHÖLZER - MOUNTING PIECES 		3		
PT01	Holzdübel - Wood dowel M8x50 TB1 > TP90-1 > PF2 		12		
PT02	Holzdübel - Wood dowel M12x100 PF1 > TB1 		6		
BFP	Befestigungsplatten für Sparren - Mounting plate for rafters 		10		
W04	Winkel - Angle bracket 90x40x40 SPR1 > PF1 		20		
W05	Winkel - Angle bracket 90x90x65 TB1 > PF1 		12		
NG04	NÄGEL - NAILS 2.5x50 Dachbretter - Roof boards 		704		
SR63	Schrauben - Screws 6.0x180 SPR1 		20		
Kood	Carport Henley 325x371		Materjal		Leht 1/2

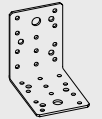
Pos	Teileliste/Specification Carport Henley 325x371	Stck Pcs.	Profil Profile (mm)	Länge Length (mm)
SR37	Schrauben - Screws 3.5x45 Giebelbretter - Gable boards Giebelsegment - Gable diamond Traufenbretter - Eaves boards	56		
SR52	Schrauben - Screws 5.0x42 W04, W05	352		
SR52	Schrauben - Screws 5.0x42 BH01	24		
SS212	Schloßschrauben - Wood bolts M12x130 Mutter - Nut M12 U-Scheibe - Washer Ø30 TP120-1/2/3 > PF1	6		
SS522	Sechskant Holzschrauben - Lag bolts M8x100 U-Scheibe - Washer M8 Ø25 für/for TP120-4, TP120-5, TP120-6, TP120-7	14		
SS532	Sechskant Holzschrauben - Lag bolts M8x120 U-Scheibe - Washer M8 Ø25 für/for TP120-4, TP120-5, TP120-6, TP120-7	28		
SS512	Sechskant Holzschrauben - Lag bolts M8x70 U-Scheibe - Washer M8 Ø25 für/for W04	20		
SS542	Sechskant Holzschrauben - Lag bolts M10x50 U-Scheibe - Washer M10 Ø30 für/for BFP	20		
SS542	Sechskant Holzschrauben - Lag bolts M10x50 U-Scheibe - Washer M10 Ø30 für/for BH01	12		
BH01	Höhenverstellbar U-Stützenschuh - Adjustable post support bracket M20	6		
	✓ - Bitte selber anpassen (falls nötig)! / Cut into length on site (if needed)!			

SR63		2
BFP		1
SS542		2

PT02		1
W05		2
SR52		32

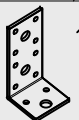
SS522		1
-------	---	---

W04		1
SR52		8
SS512		1

PT01		2
------	---	---

SS532		1
-------	---	---

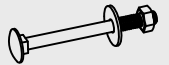
SS212		1
-------	--	---

Name	Carport Henley 325x371		
Zeichnung/Drawing	3D		
Profil/Profile	Datum/Date	27.10.2021	

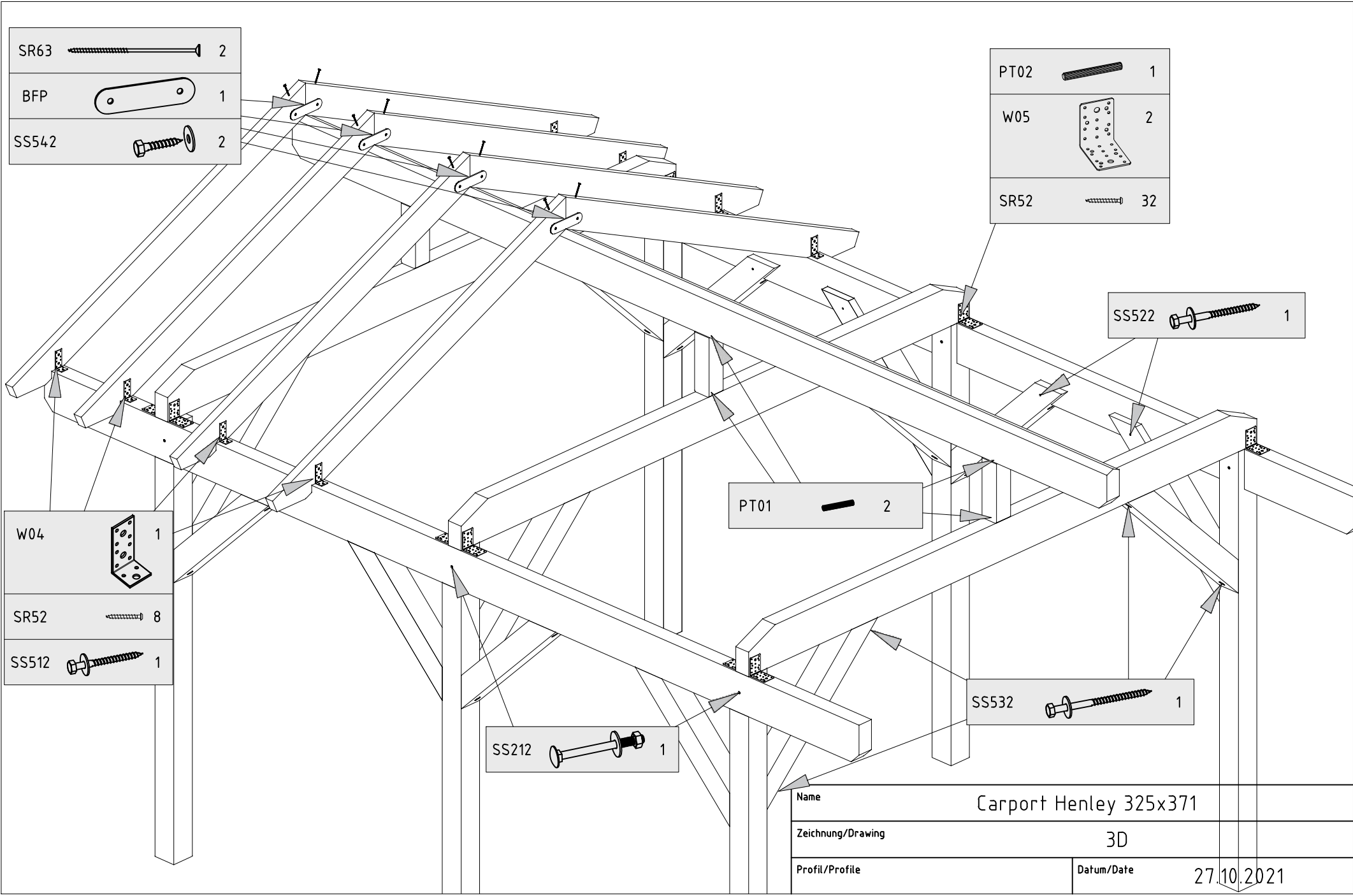

1

SS532

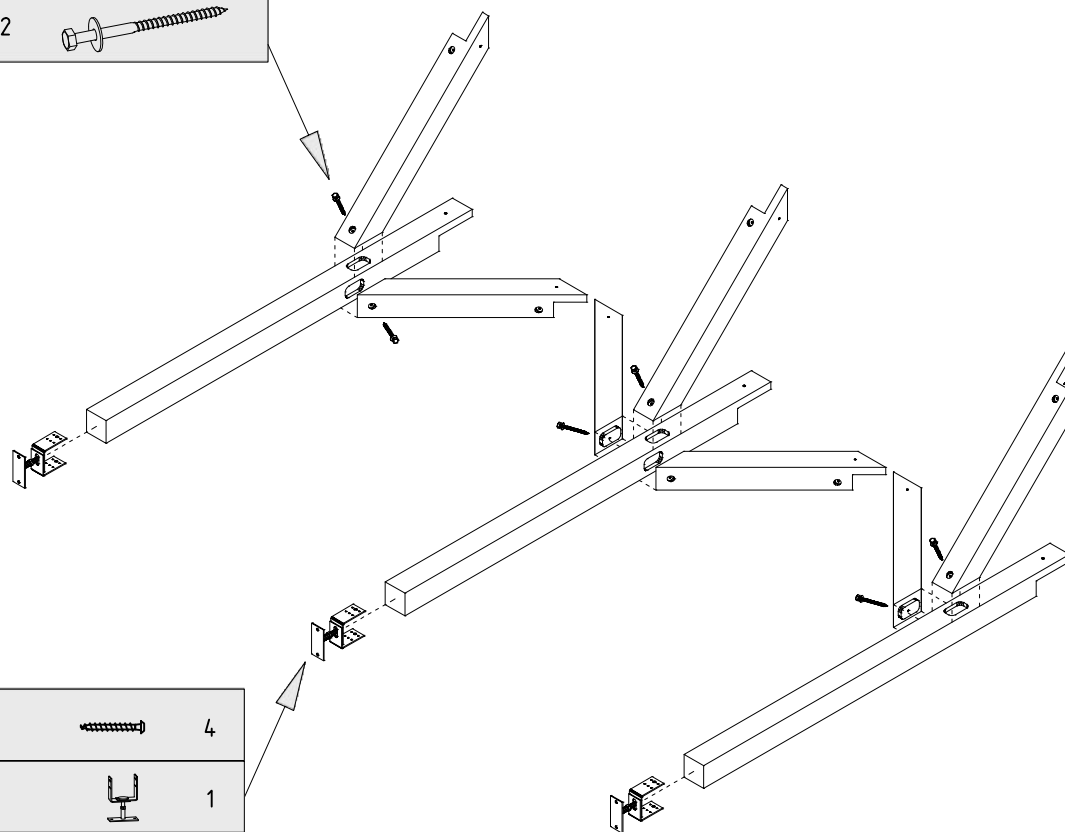

SR52



4

BH01



1

SS542



2

2

SS522

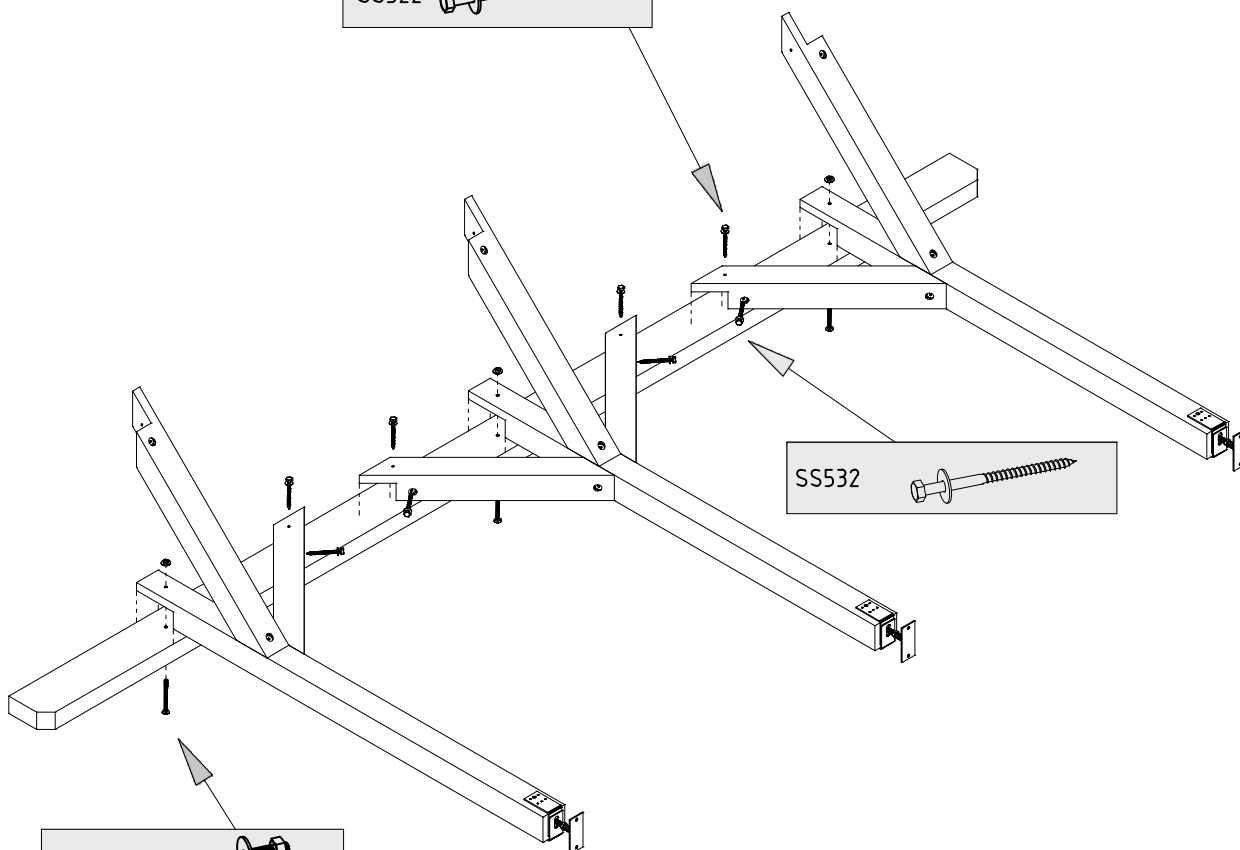

SS532



SS212

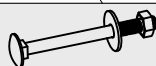

3

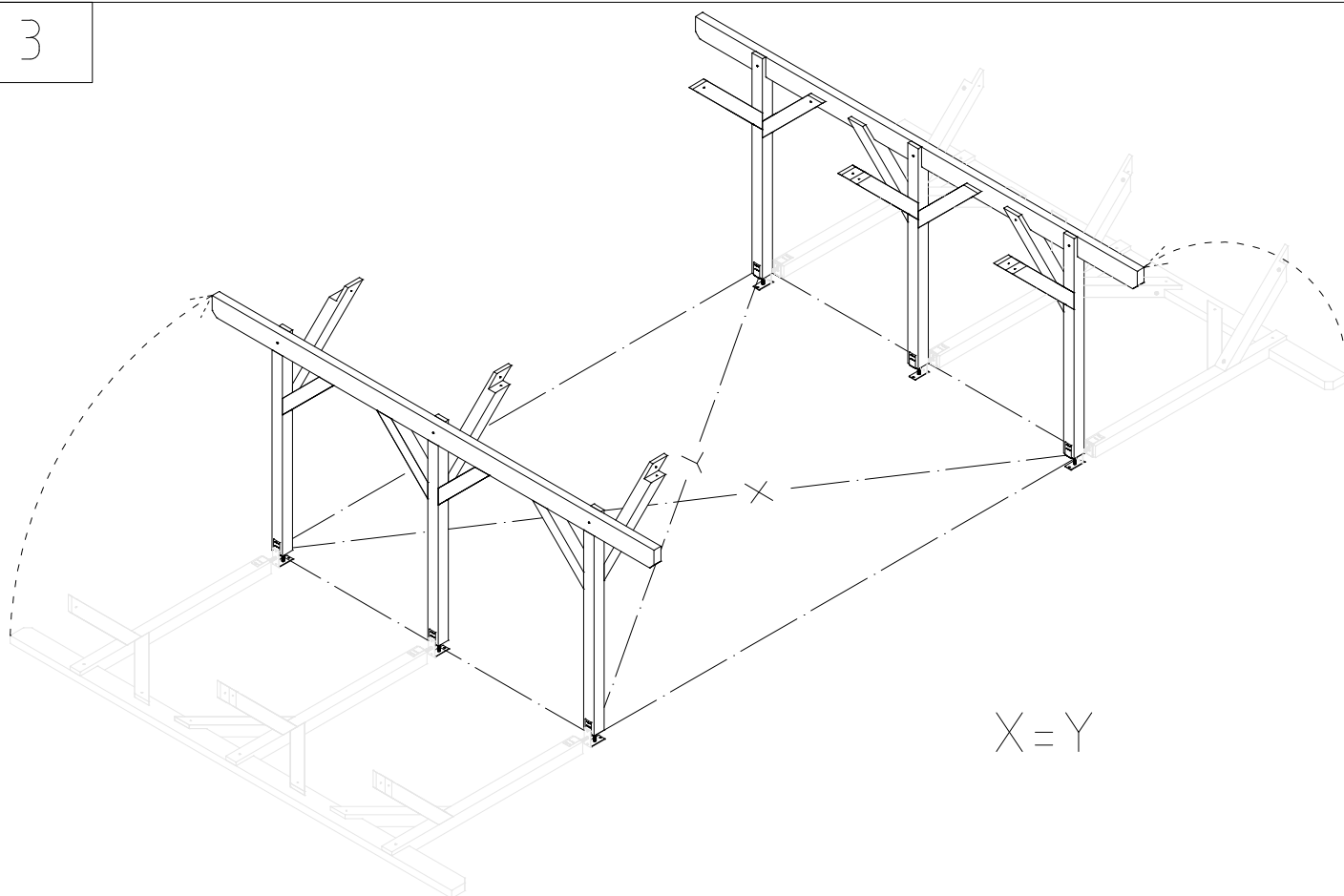

X=Y

NB! Unterstützung bei Bedarf / Support when needed / Vajadusel toestage

4

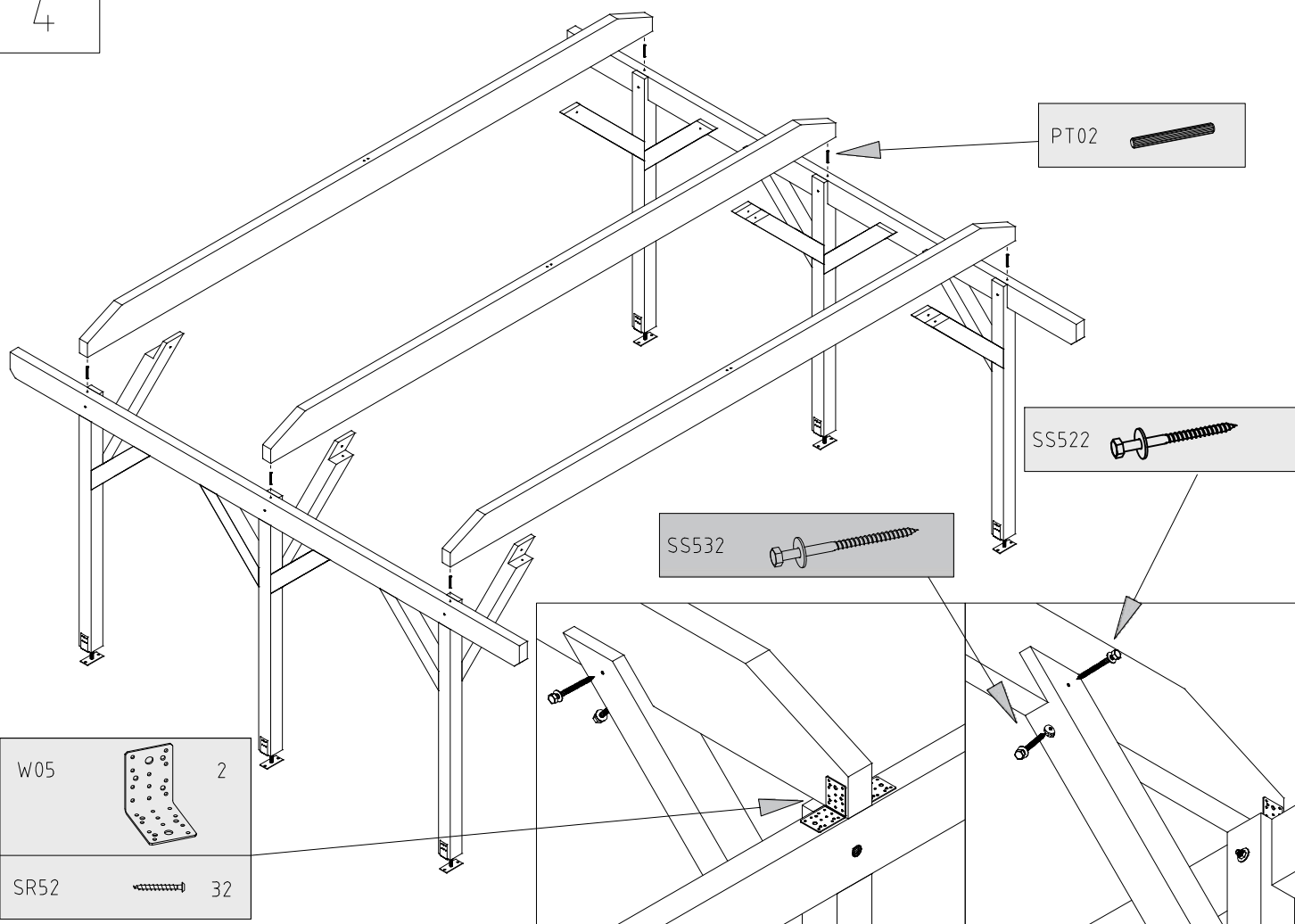

5

PT01

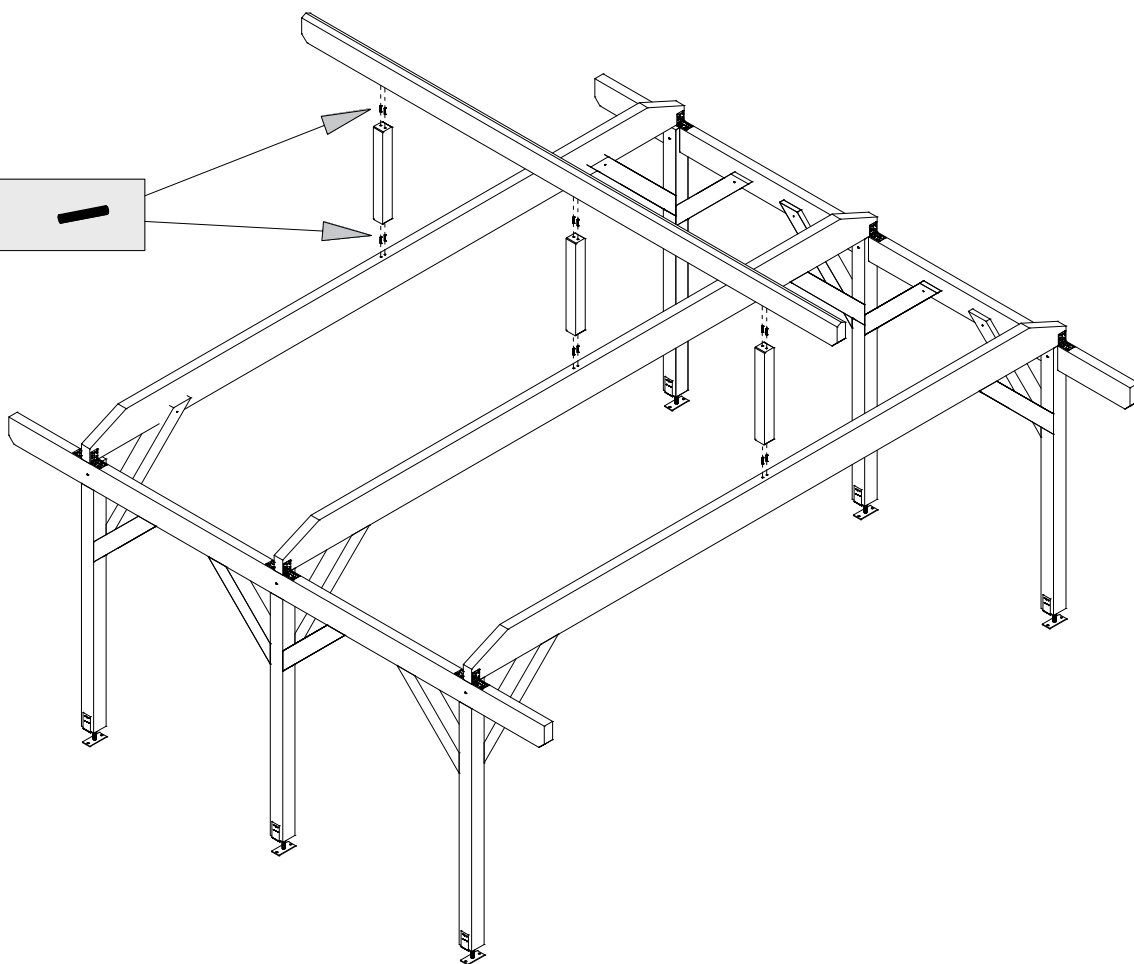

NB! Unterstützung bei Bedarf / Support when needed / Vajadusel toestage

6

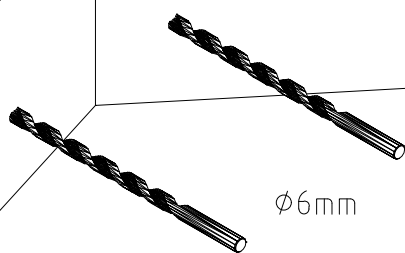

NB! Bohren Sie ein Loch vor / Predrill a hole / Puurige auk ette

7

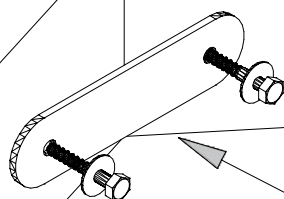

BFP

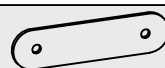

SS542



8

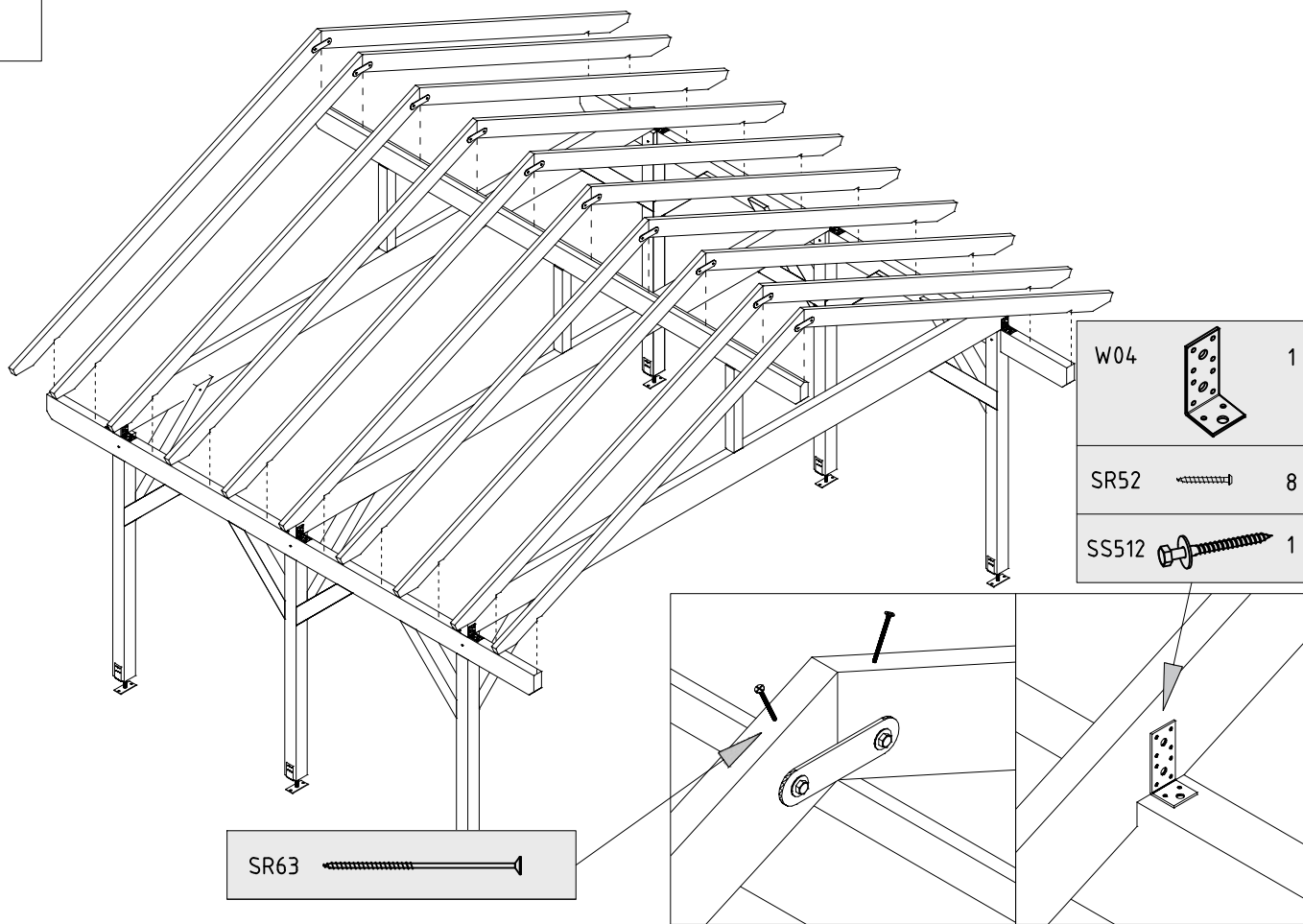

9

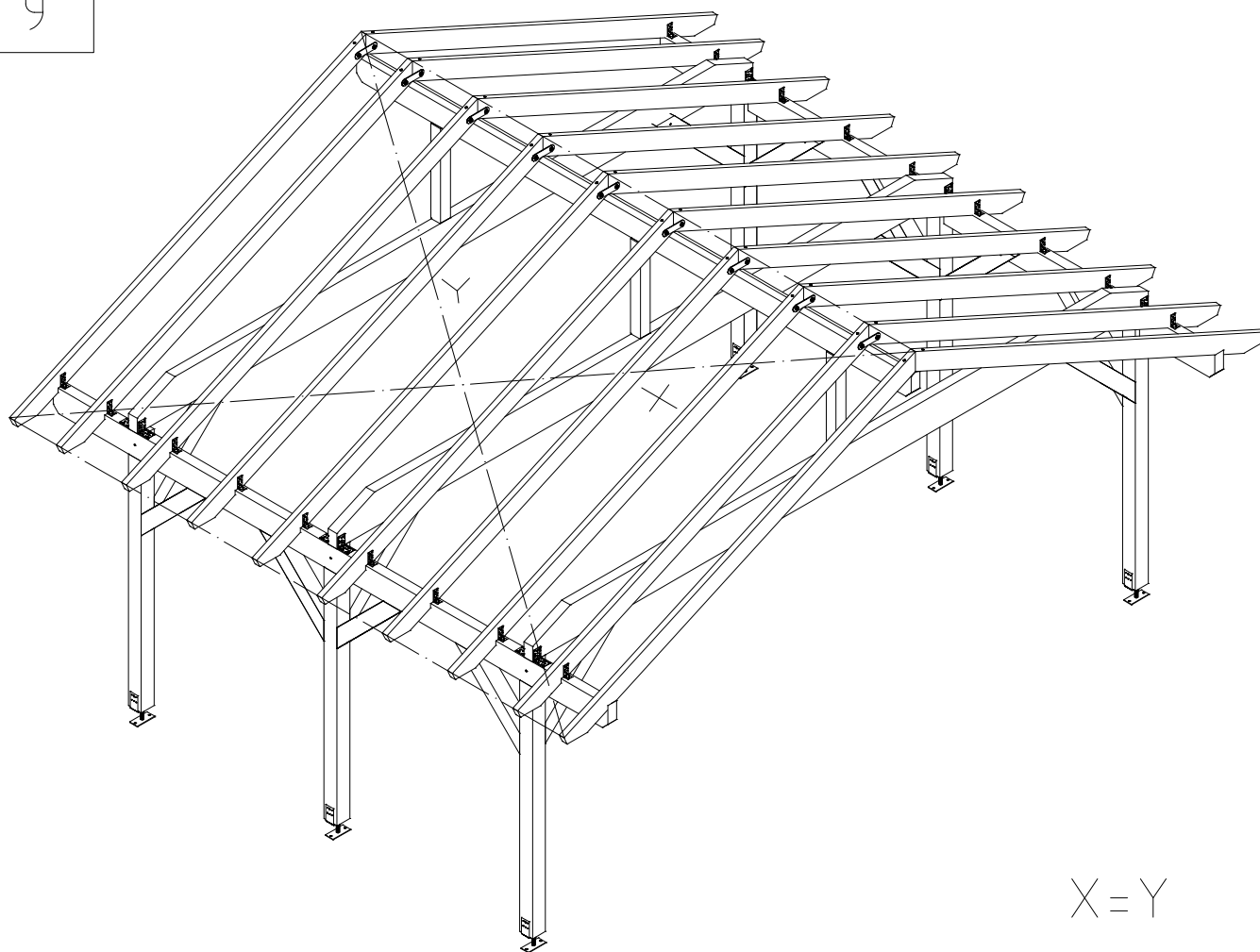

10

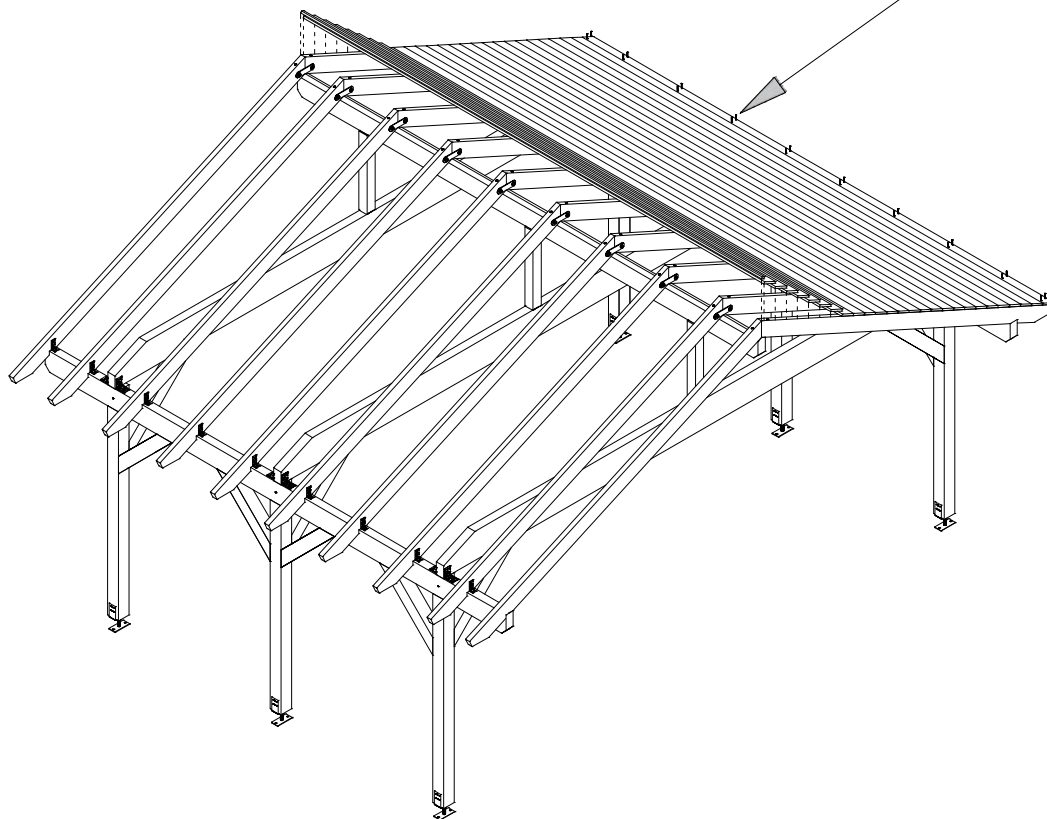

11

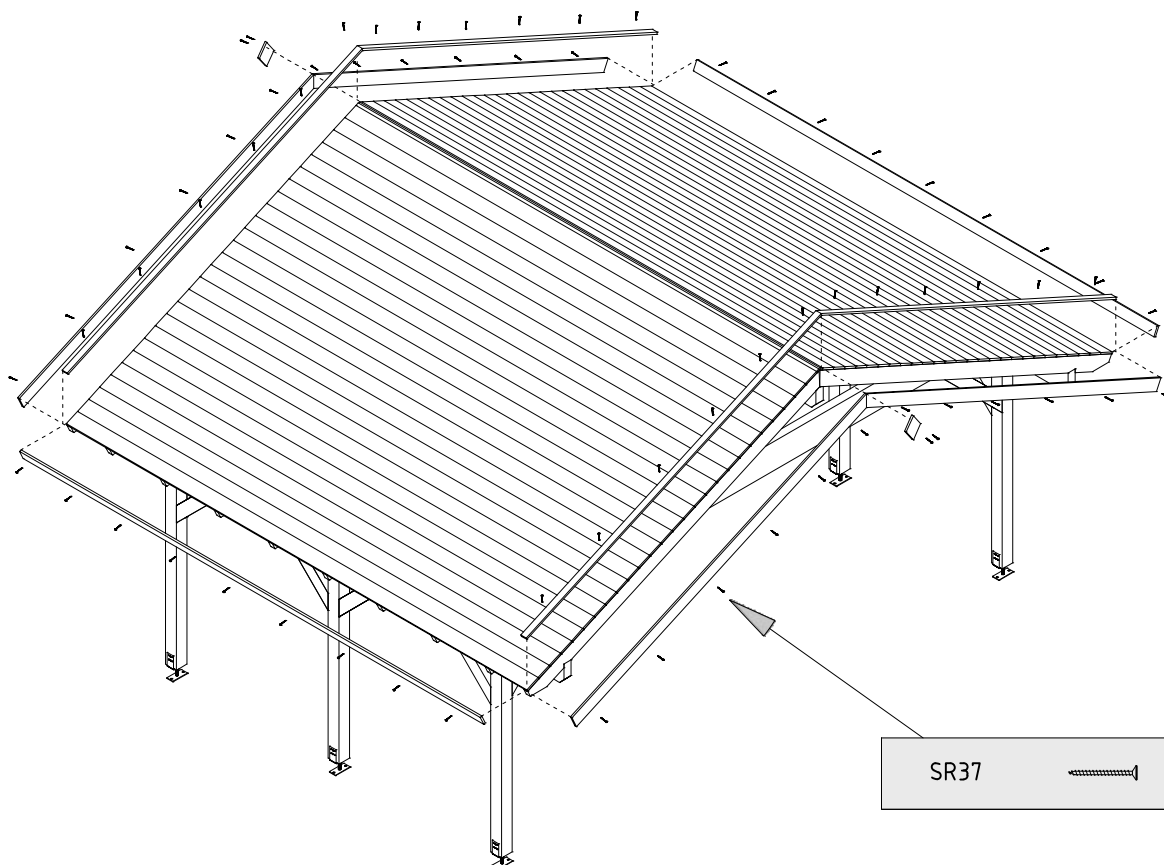

NB! Spannen Sie die Holzschrauben innerhalb einer Woche nach!

NB! Tighten the Bolts within a week!

NB! Nädata jooksul pingutada poldid üle!

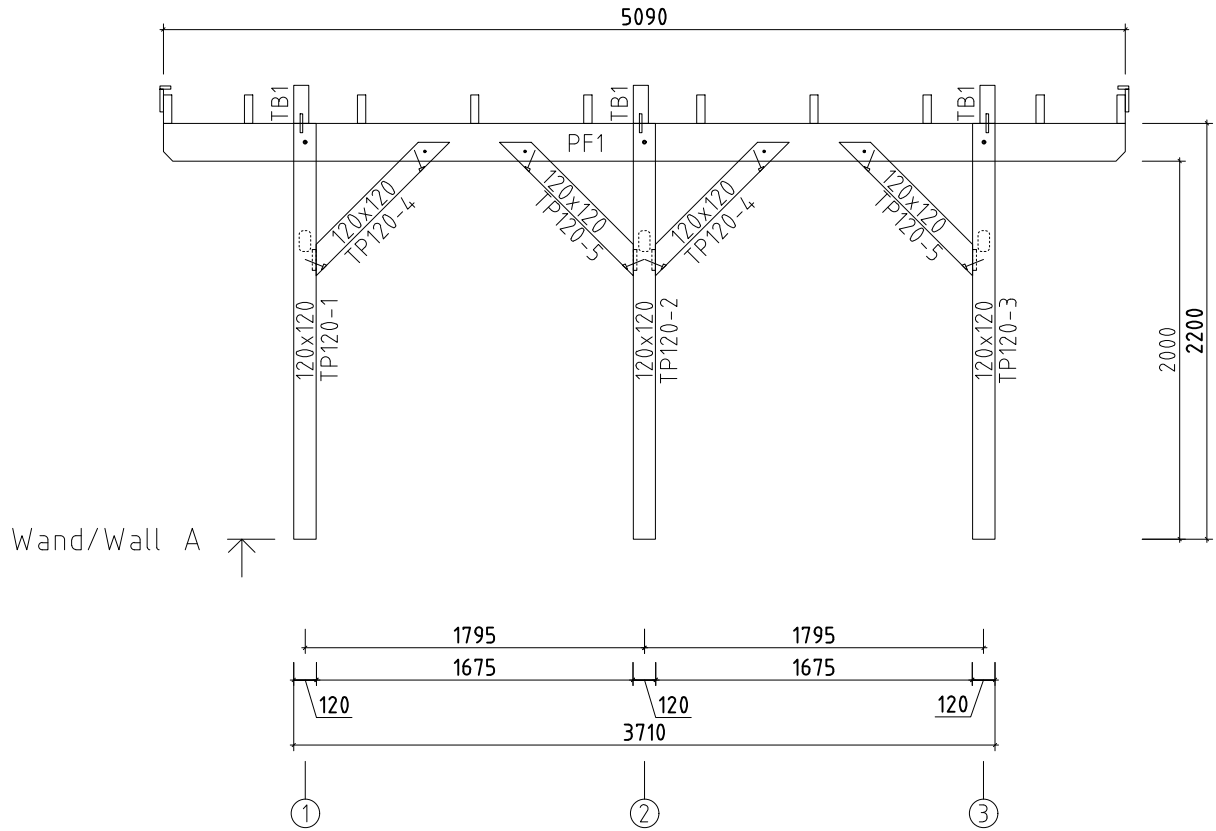
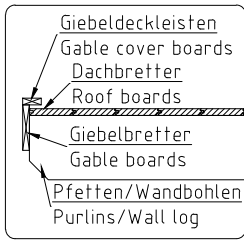

Name	Carport Henley 325x371		
Zeichnung/Drawing	WAND/WALL A		
Profil/Profile	Datum/Date	27.10.2021	

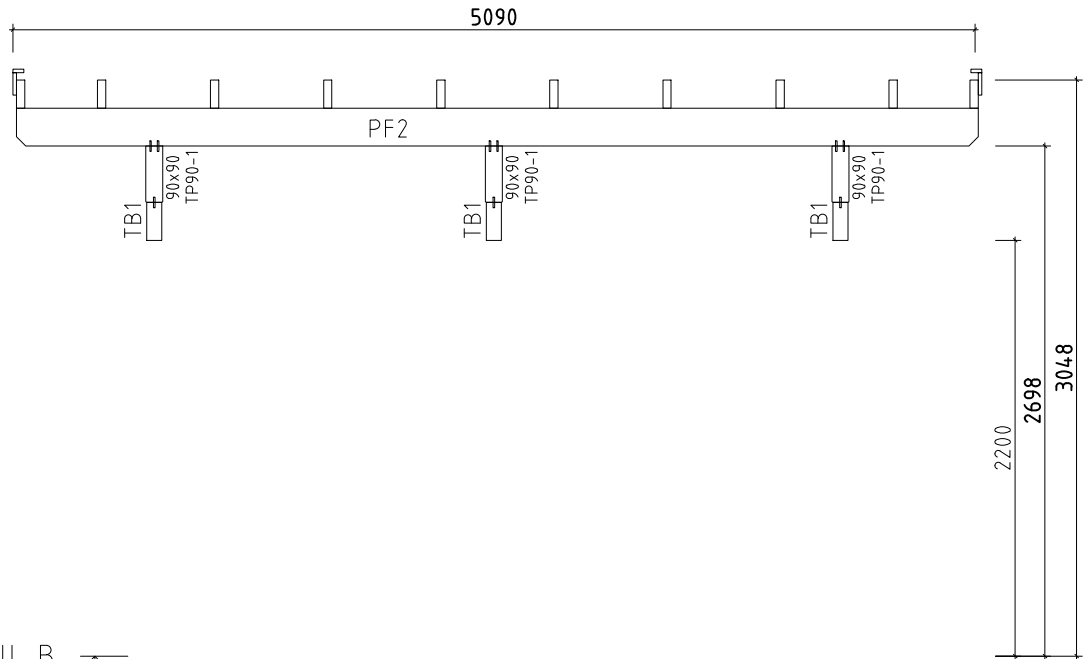

Wand/Wall B ↗

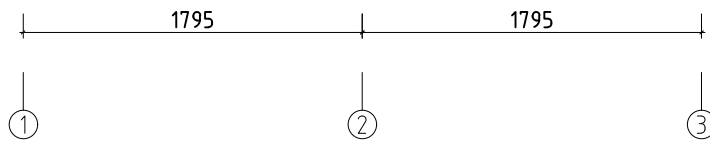

Name	Carport Henley 325x371	
Zeichnung/Drawing	WAND/WALL B	
Profil/Profile	Datum/Date	27.10.2021

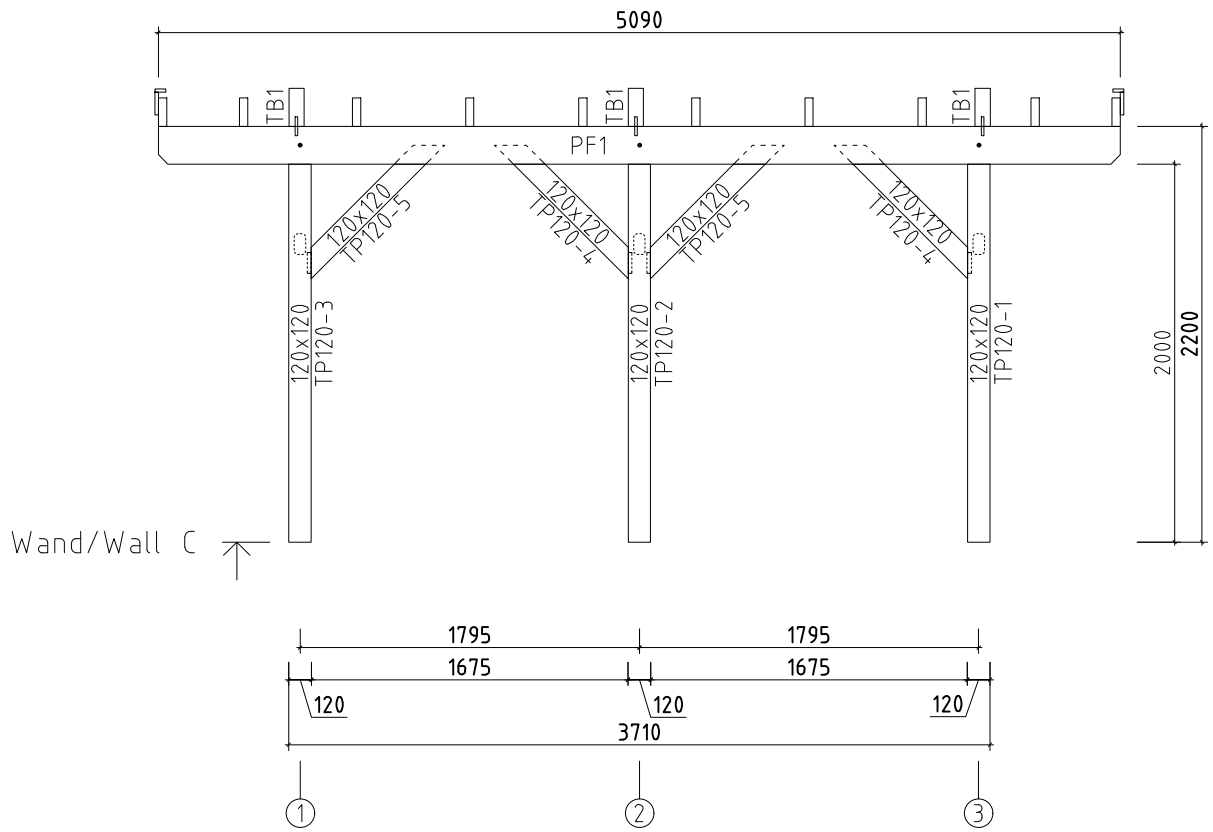

Name	Carport Henley 325x371		
Zeichnung/Drawing	WAND/WALL C		
Profil/Profile		Datum/Date	27.10.2021

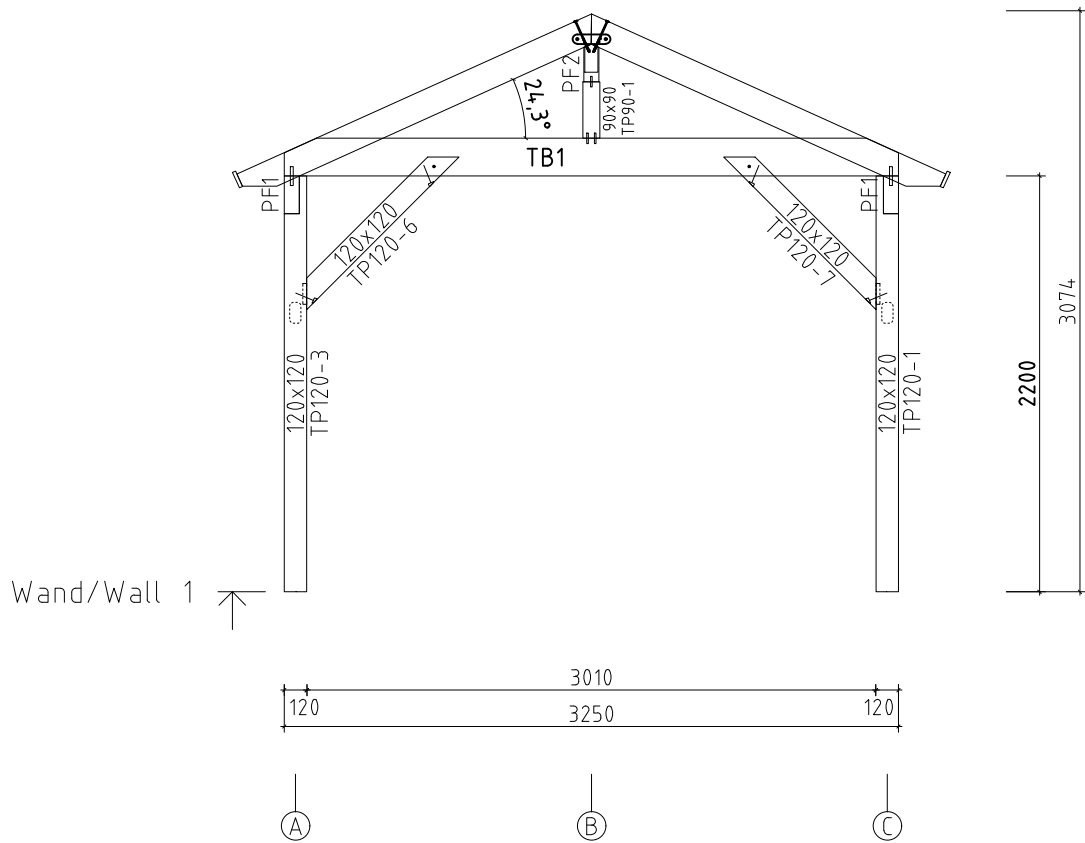

Name	Carport Henley 325x371	
Zeichnung/Drawing	WAND/WALL 1	
Profil/Profile	Datum/Date	27.10.2021

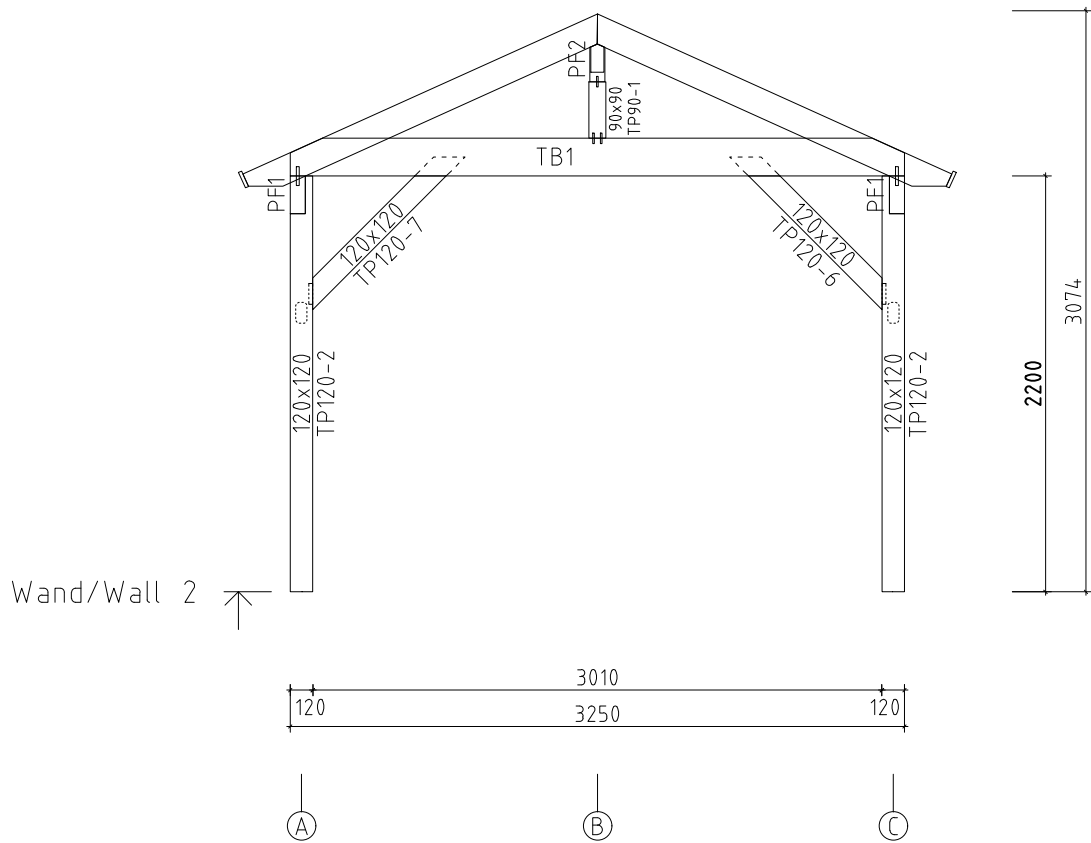

Name	Carport Henley 325x371	
Zeichnung/Drawing	WAND/WALL 2	
Profil/Profile	Datum/Date	27.10.2021

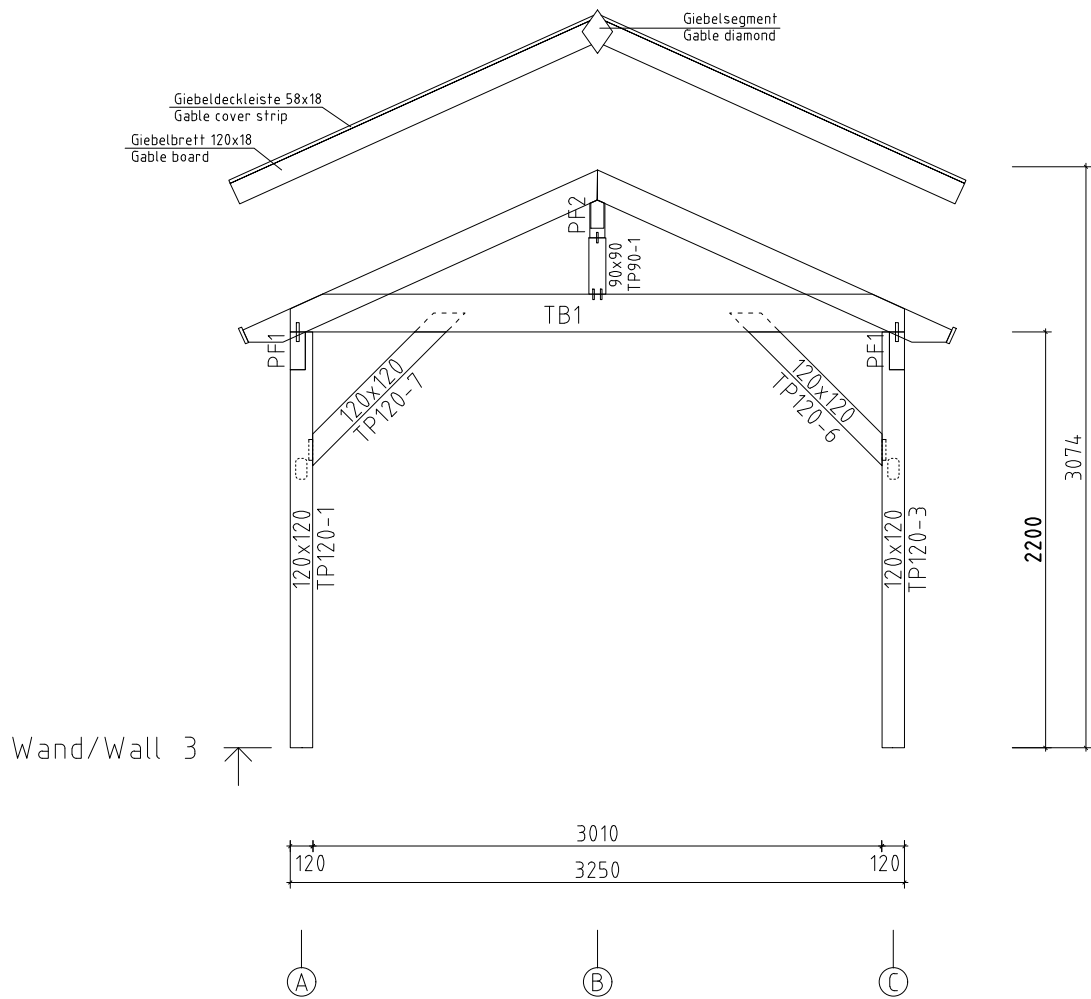

Name	Carport Henley 325x371	
Zeichnung/Drawing	WAND/WALL 3	
Profil/Profile	Datum/Date	27.10.2021