

Name	Conference Room 14.20x7.20 88	
Zeichnung/Drawing	3D	
Profil/Profile	8.8x18.0	Datum/Date 20.04.2023

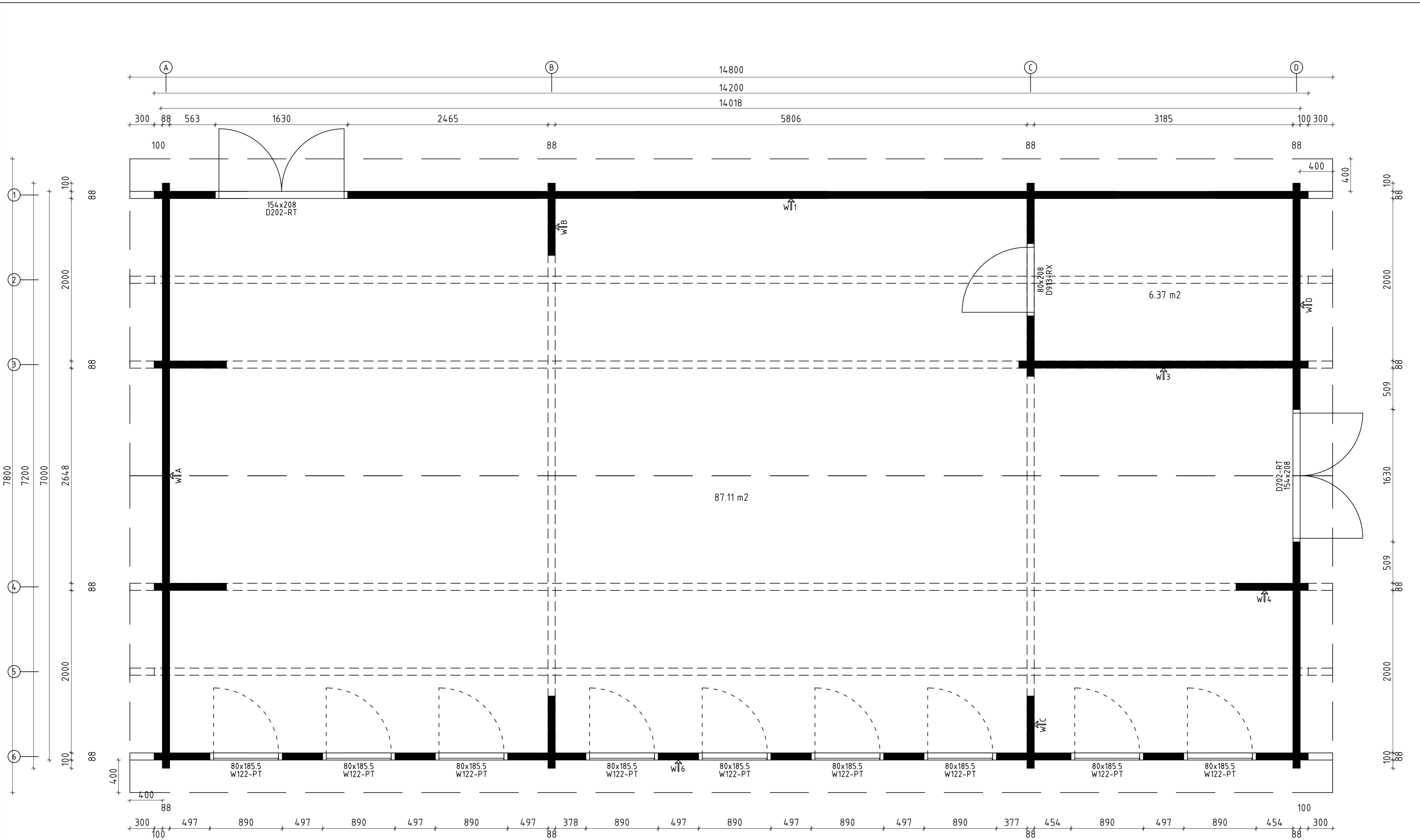

* Fenster und Türen sind mit Sprossen/
Windows and doors are with muntins

Q6 – Qualitätsklasse für Fenster und Türen/
Quality class for windows and doors

Name	Conference Room 720x1420 88		
Zeichnung/Drawing	Grundplan_Plan		
Profil/Profile	8.8x18.0	Datum/Date	20.04.2023

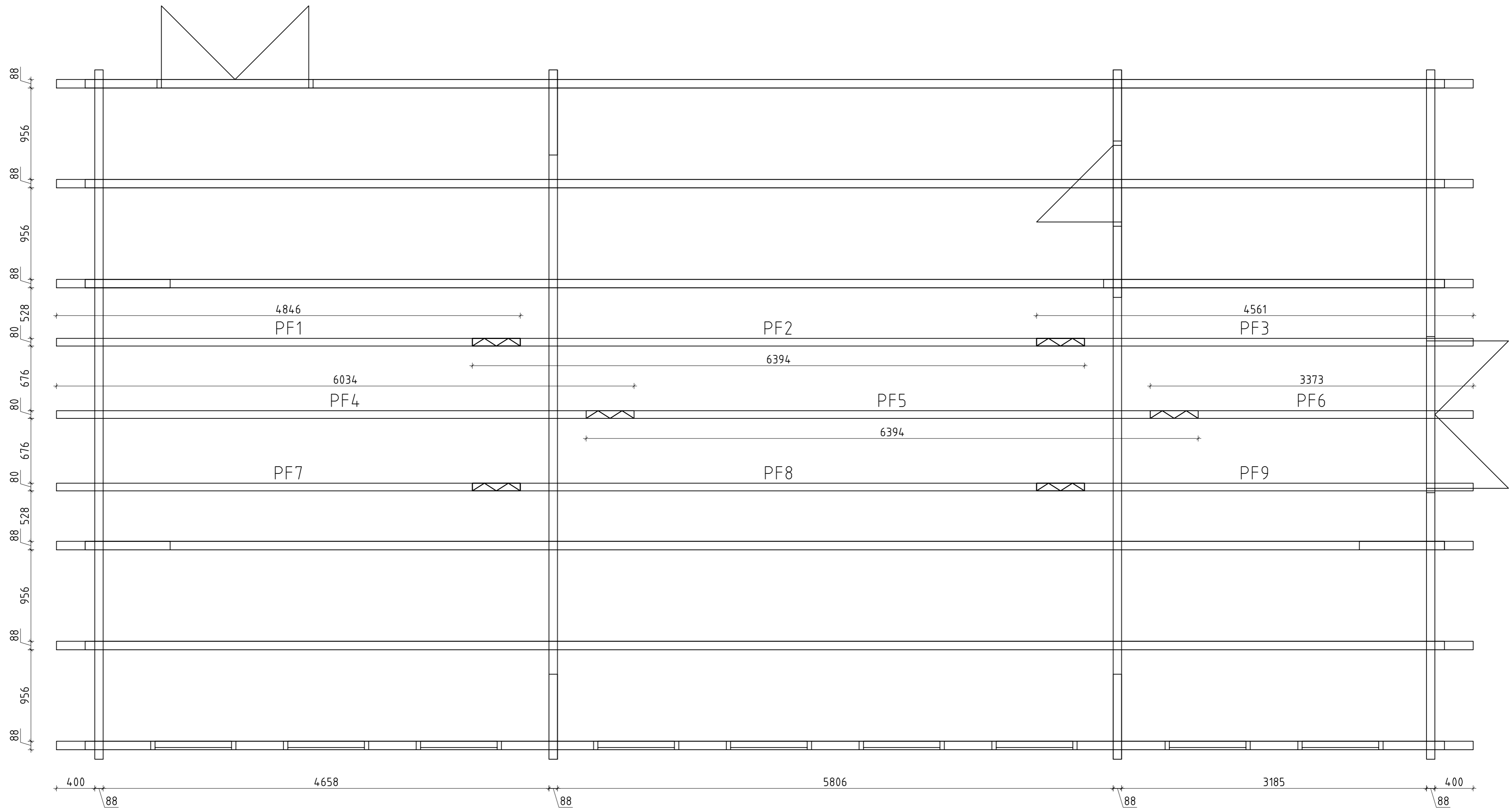

Name	Conference Room 720x1420 88		
Zeichnung/Drawing	Pfetten_Purlins		
Profil/Profile	8.8x18.0	Datum/Date	20.04.2023

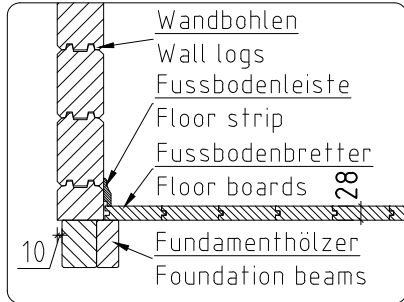
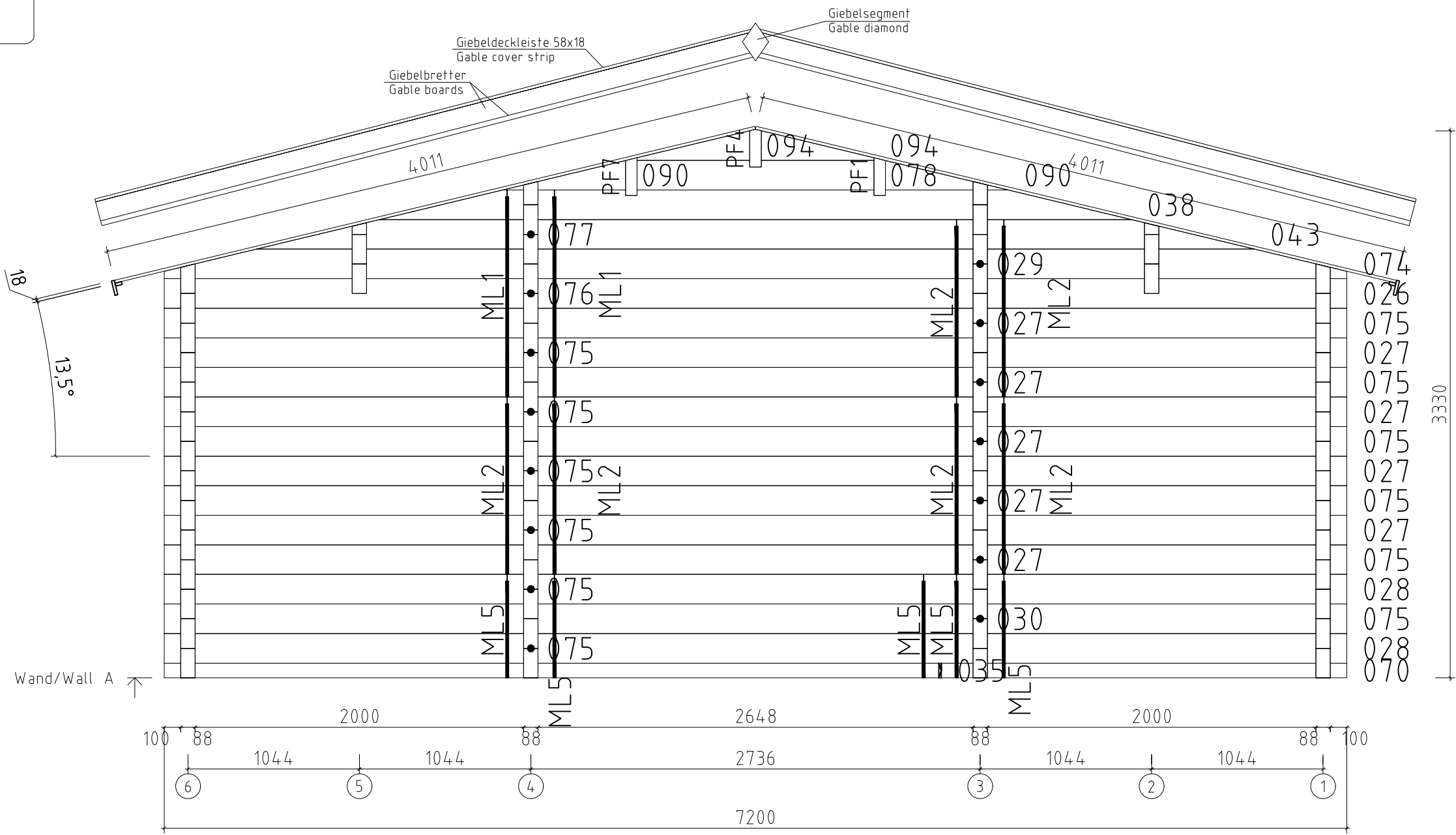
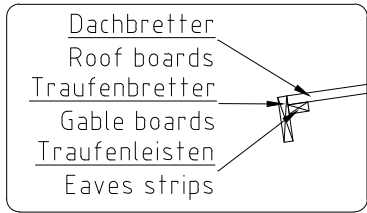

Name	Conference Room 720x1420 88		
Zeichnung/Drawing	WAND/WALL A		
Profil/Profile	8.8x18	Datum/Date	20.04.2023

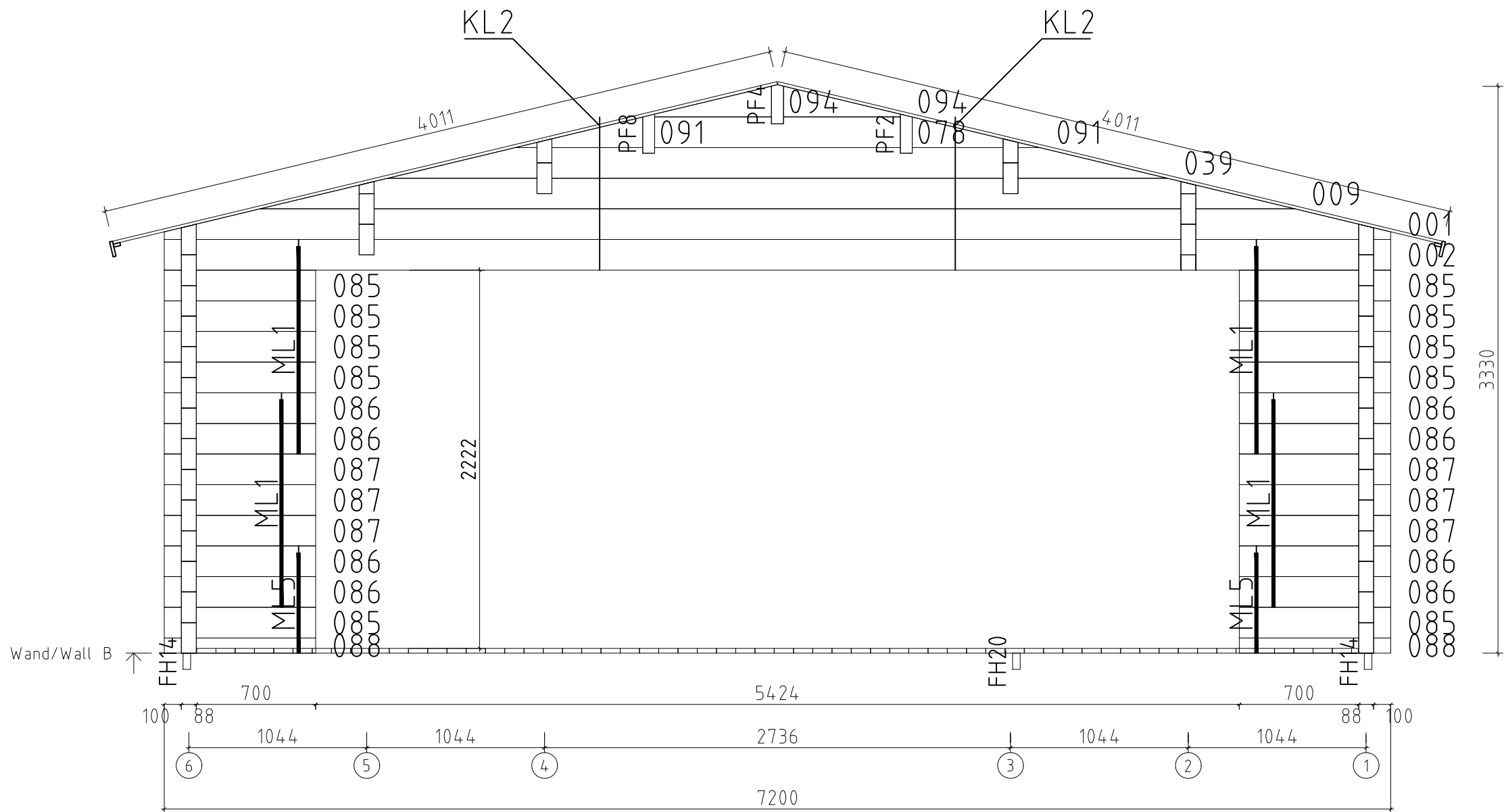

Name	Conference Room 720x1420 88		
Zeichnung/Drawing	WAND/WALL B		
Profil/Profile	8.8x18	Datum/Date	20.04.2023

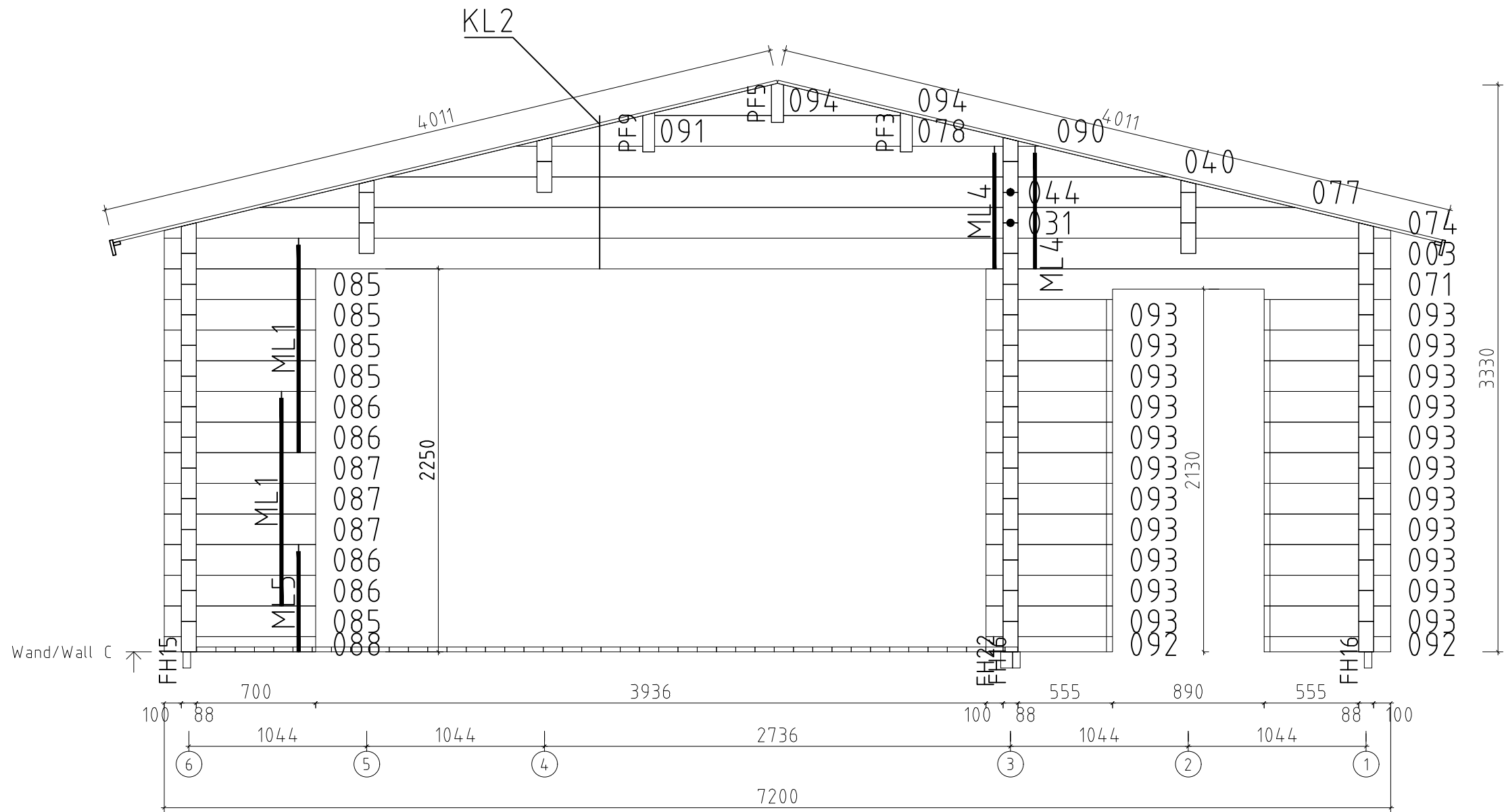

Name	Conference Room 720x1420 88		
Zeichnung/Drawing	WAND/WALL C		
Profil/Profile	8.8x18	Datum/Date	20.04.2023

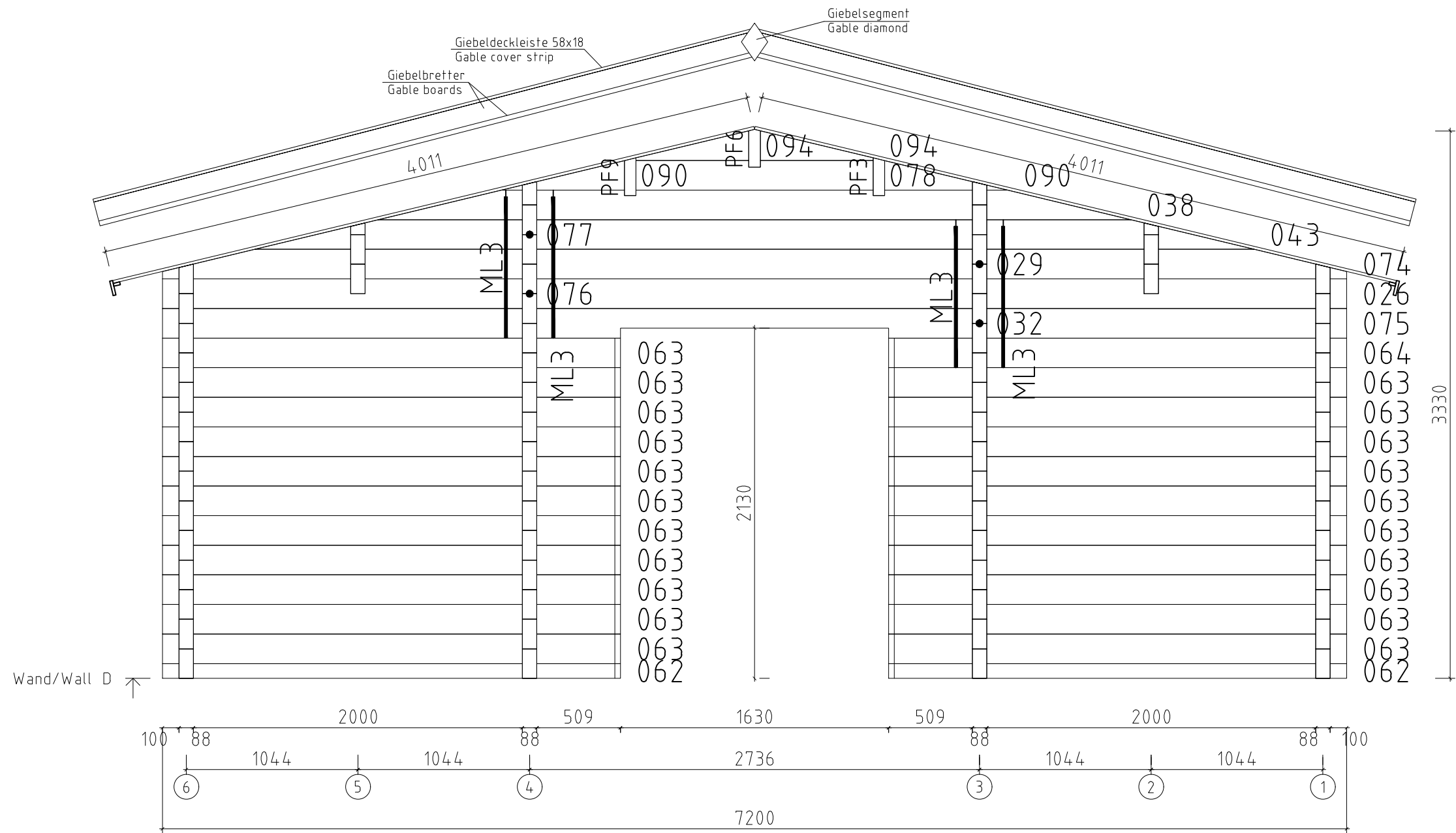

Name	Conference Room 720x1420 88		
Zeichnung/Drawing	WAND/WALL D		
Profil/Profile	8.8x18	Datum/Date	20.04.2023

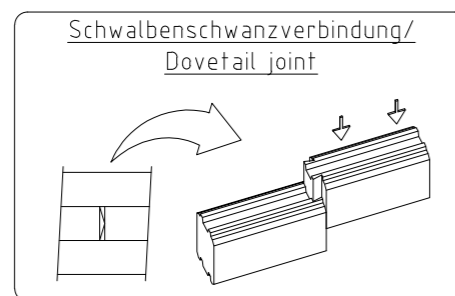
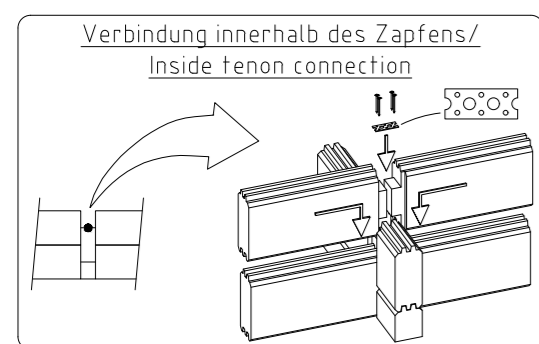
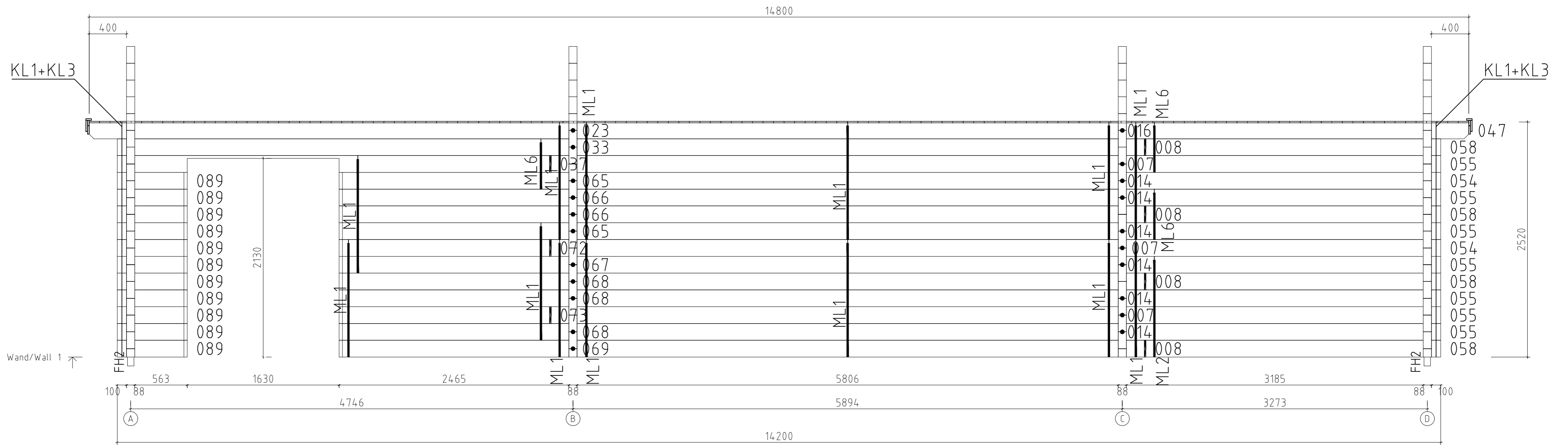
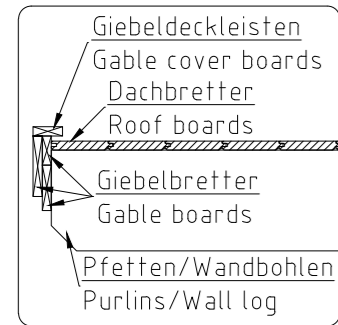

Name	Conference Room 720x1420 88		
Zeichnung/Drawing	WAND/WALL 1		
Profil/Profile	8.8x18	Datum/Date	20.04.2023

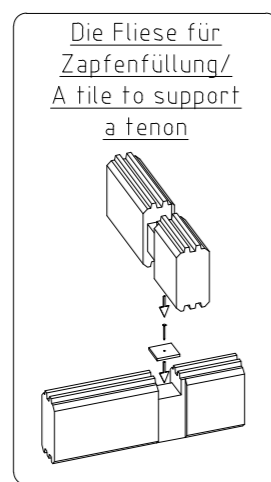
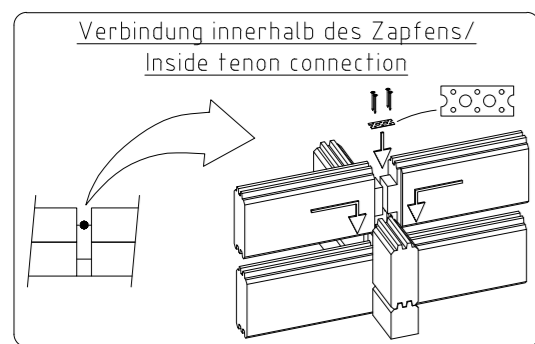
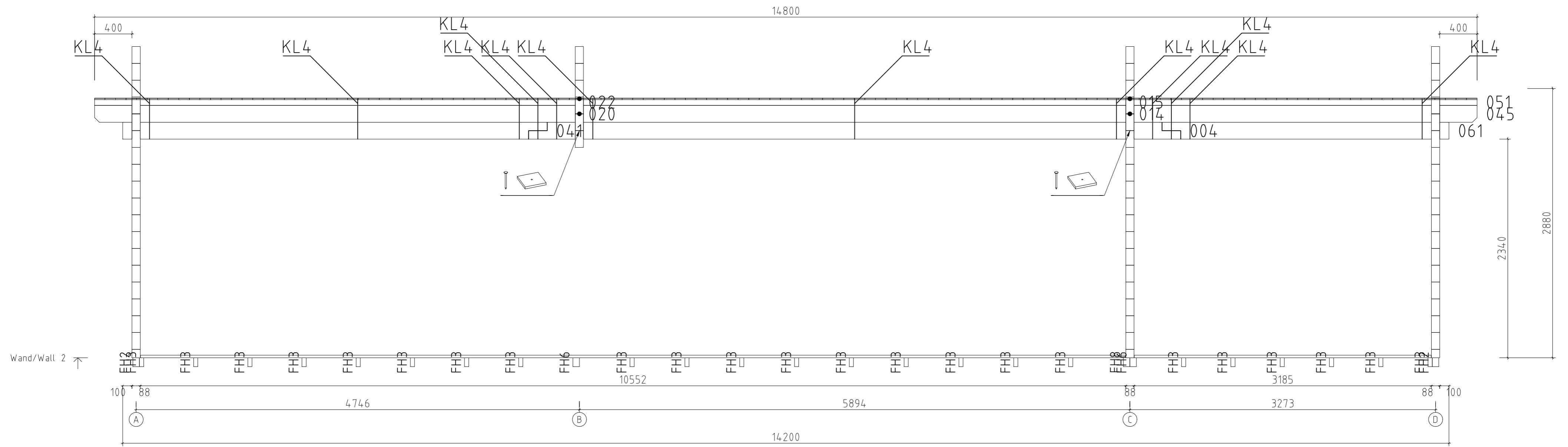

Name	Conference Room 720x1420 88		
Zeichnung/Drawing	WAND/WALL 2		
Profil/Profile	8.8x18	Datum/Date	20.04.2023

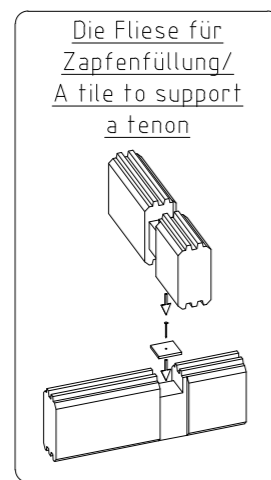
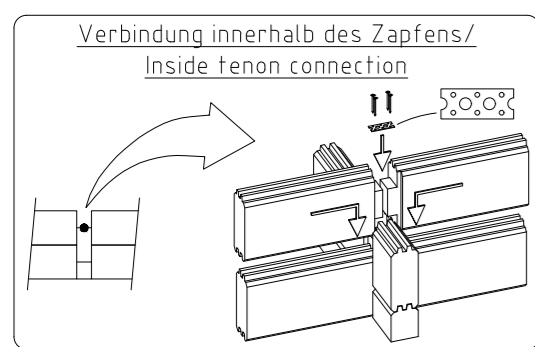
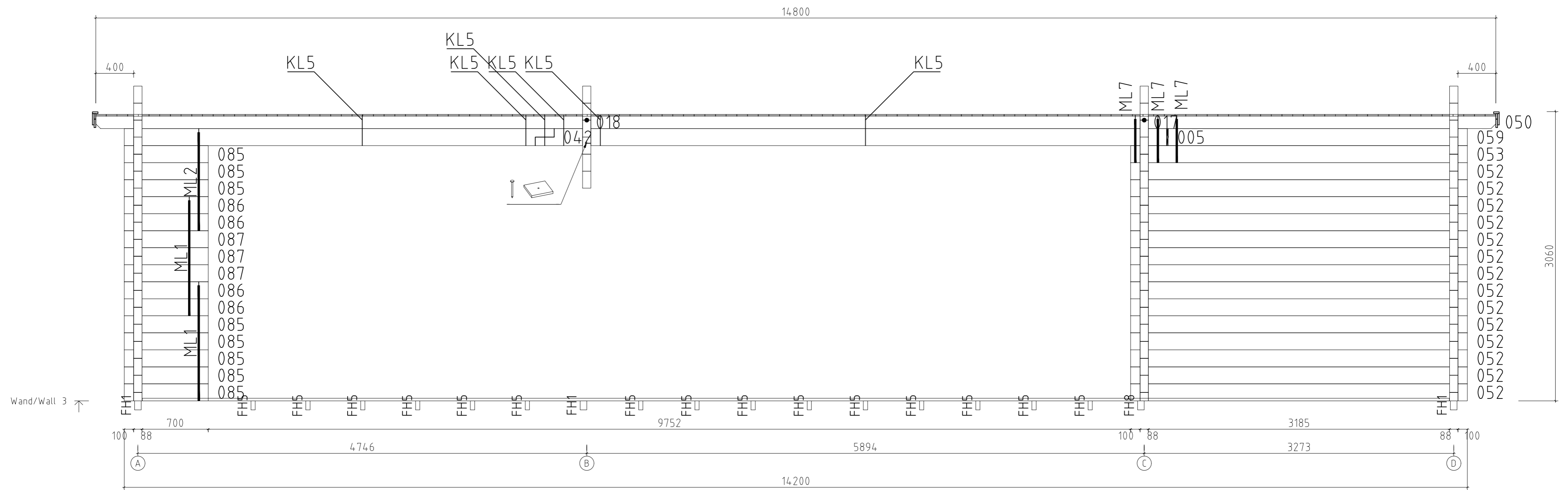



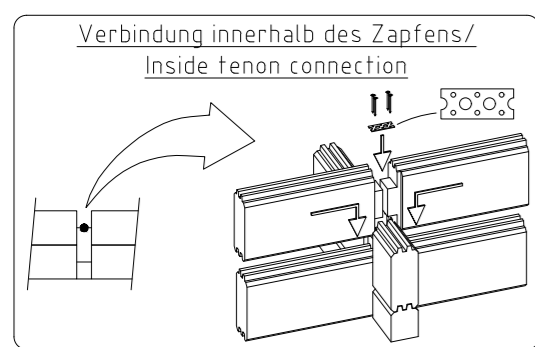
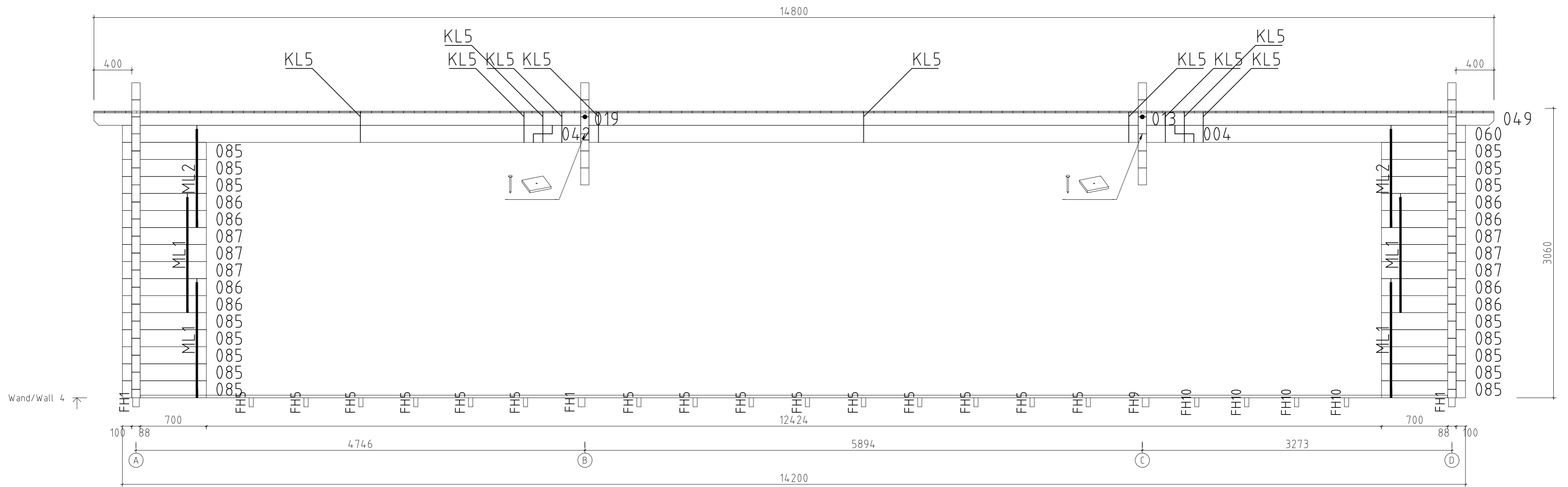

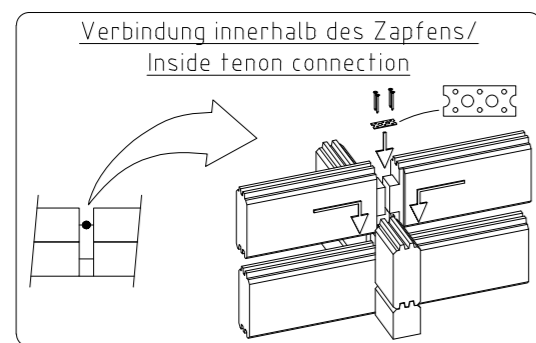
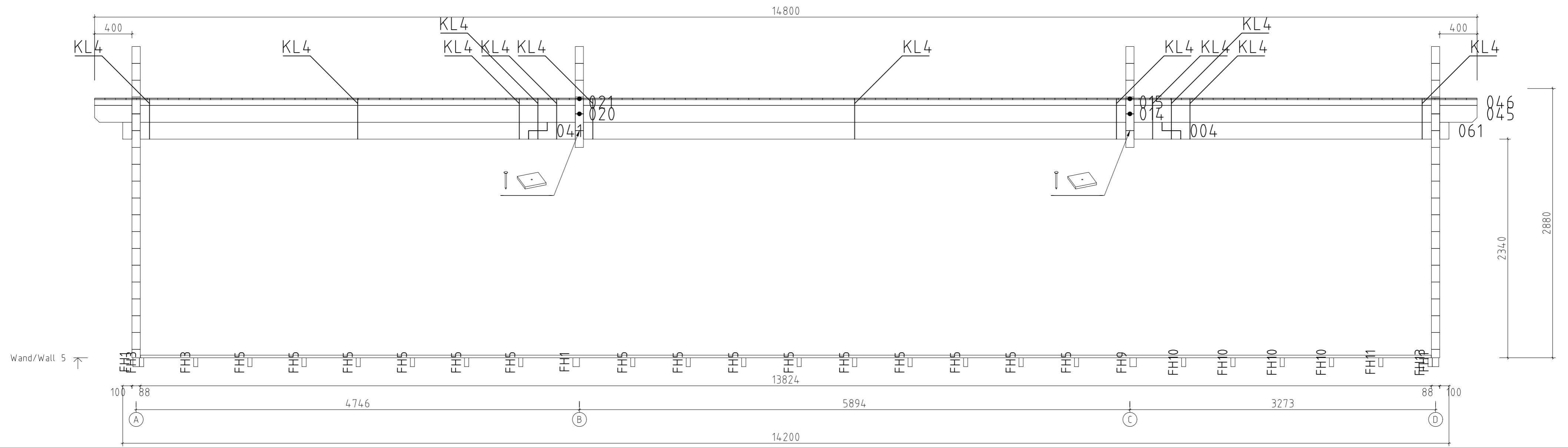

Name	Conference Room 720x1420 88		
Zeichnung/Drawing	WAND/WALL 3		
Profil/Profile	8.8x18	Datum/Date	20.04.2023



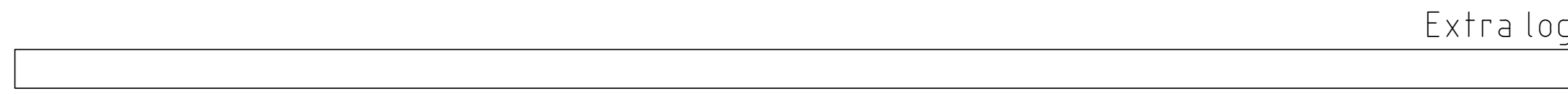
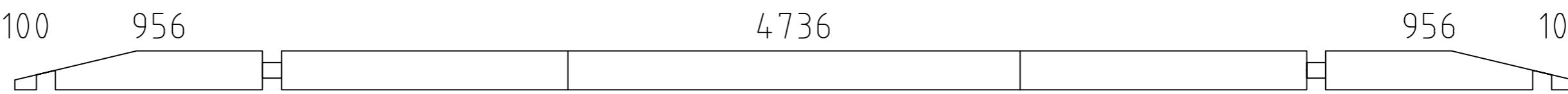
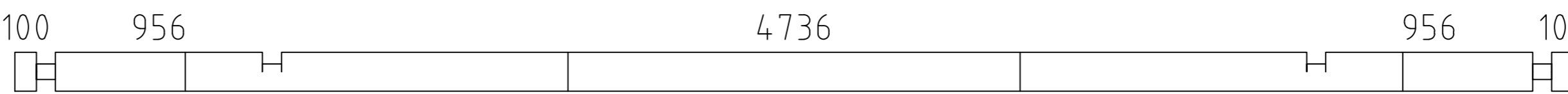
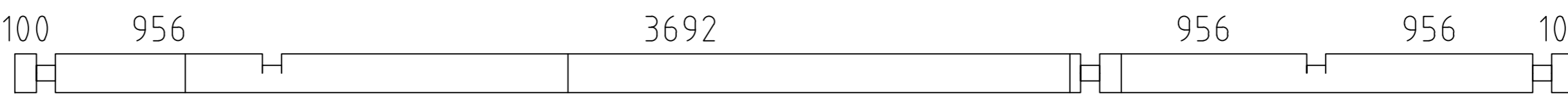
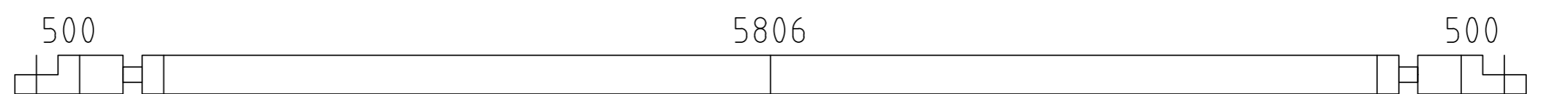
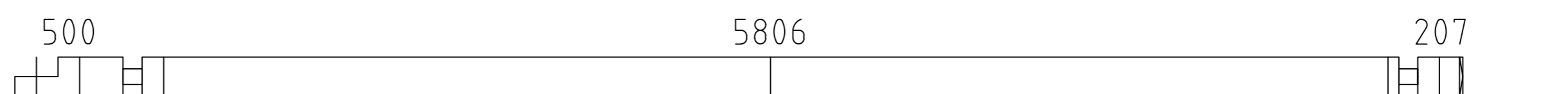
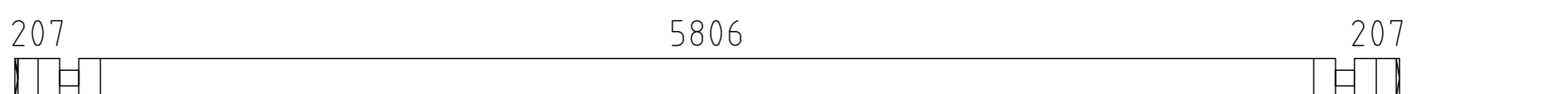
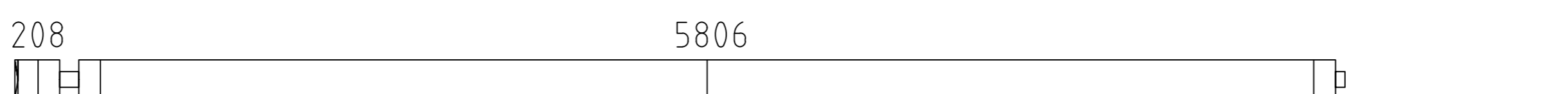

Name	Conference Room 720x1420 88		
Zeichnung/Drawing	WAND/WALL 4		
Profil/Profile	8.8x18	Datum/Date	20.04.2023

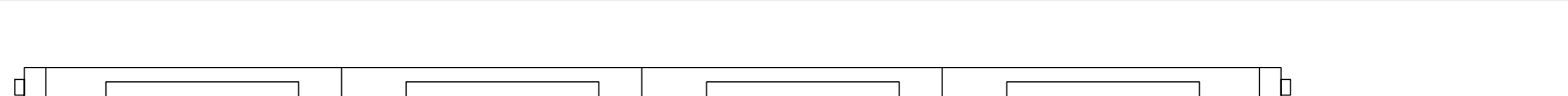

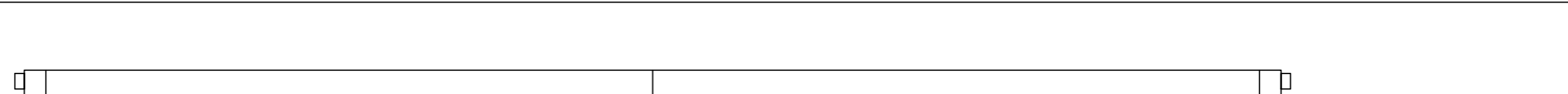
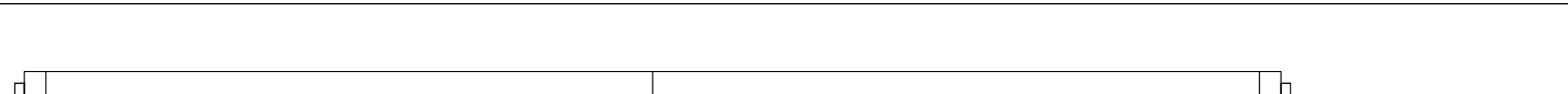
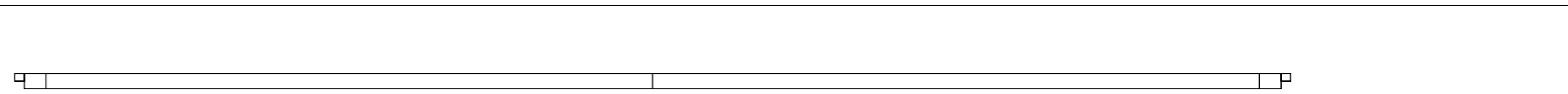
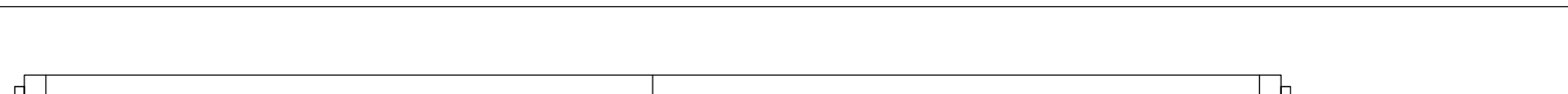
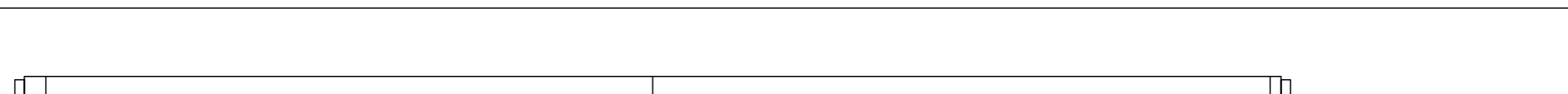
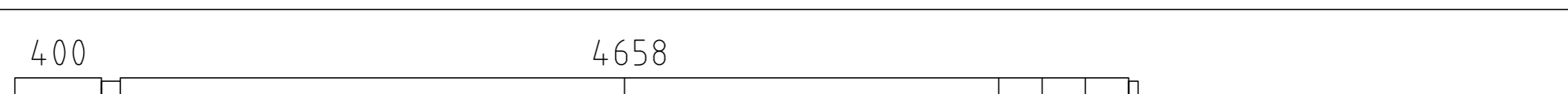
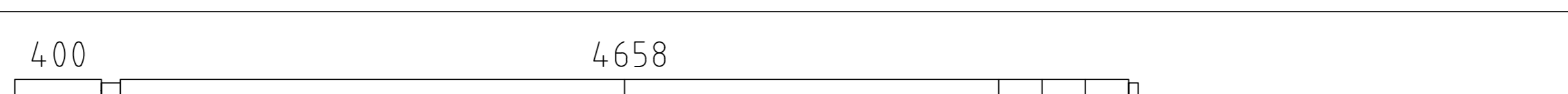
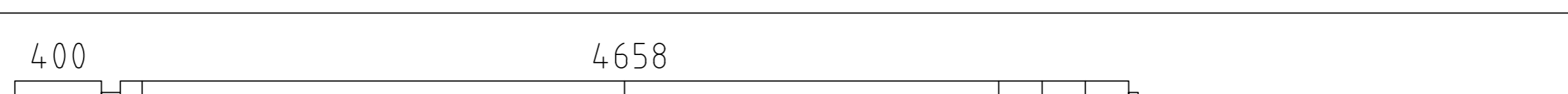
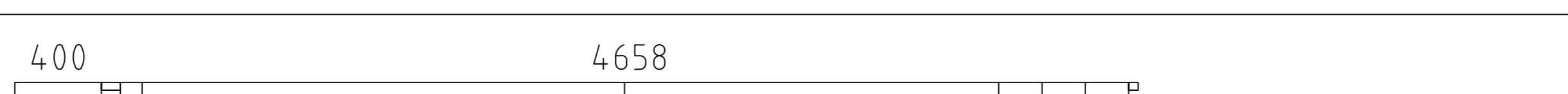
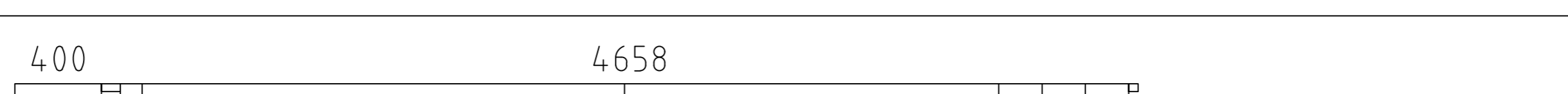
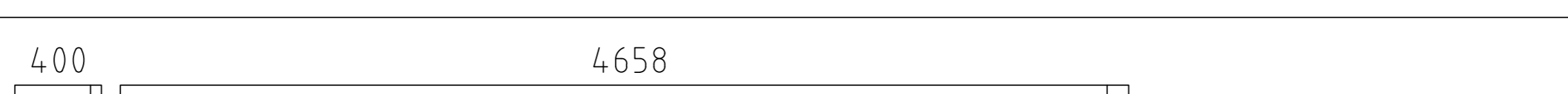
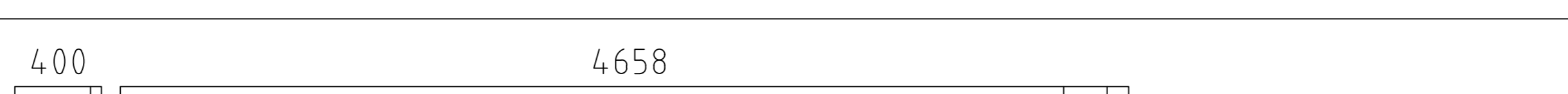
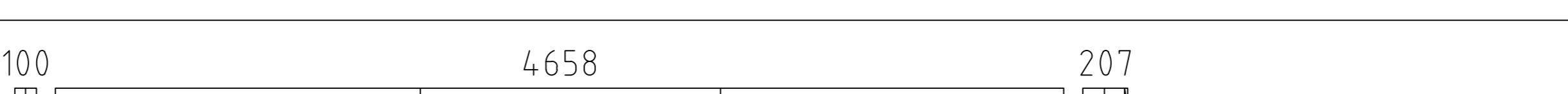

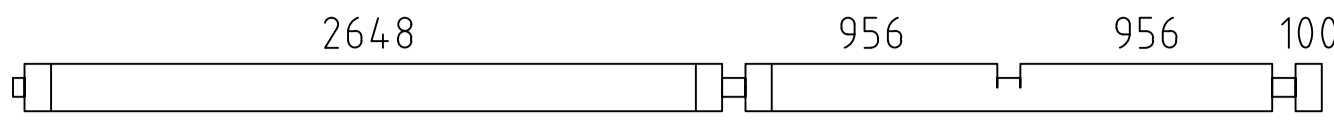
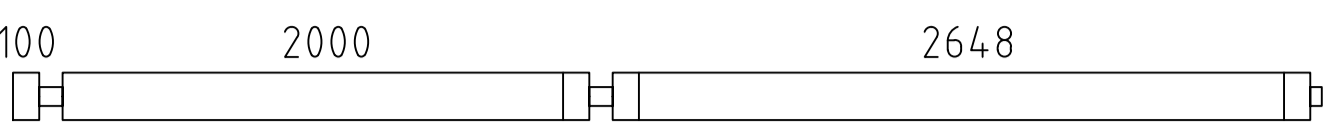
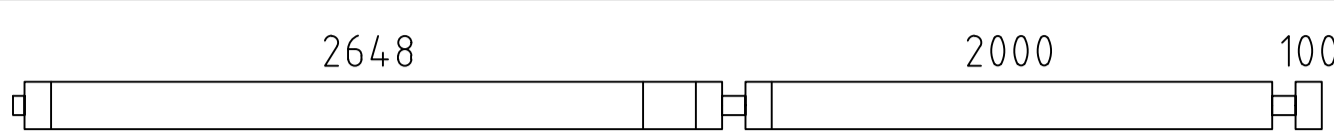
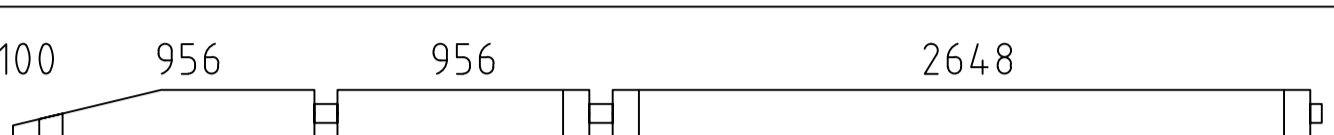
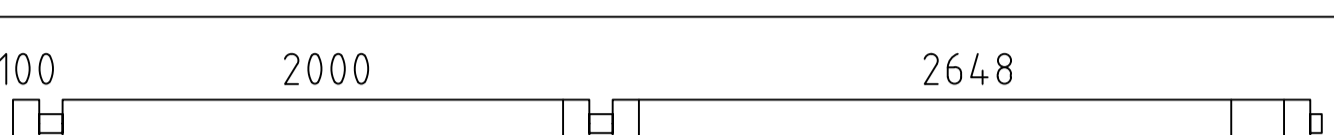
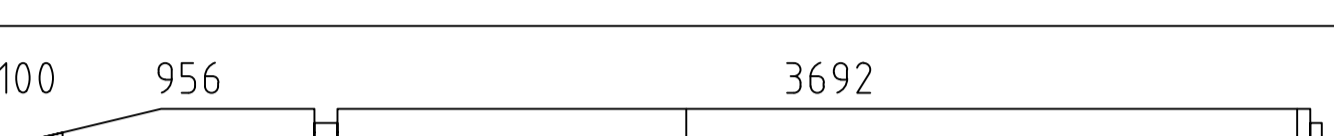
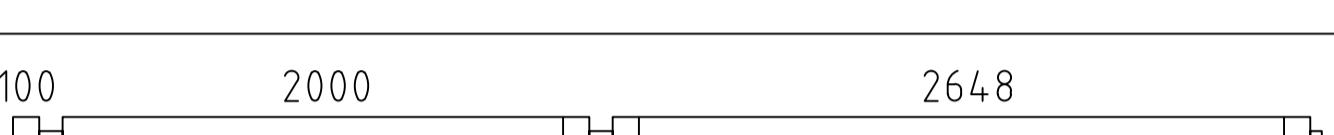
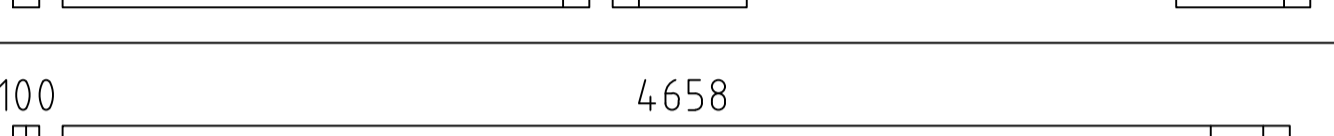
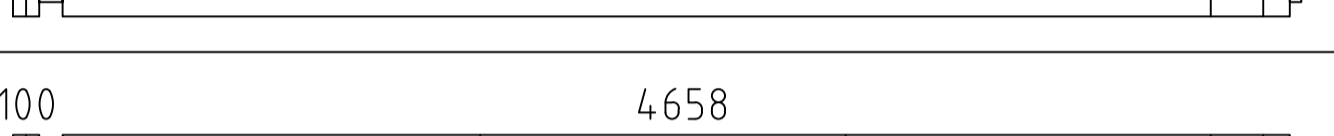

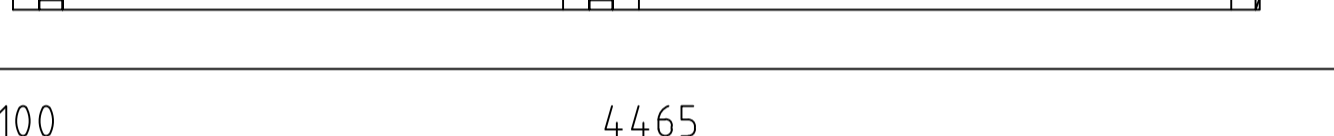
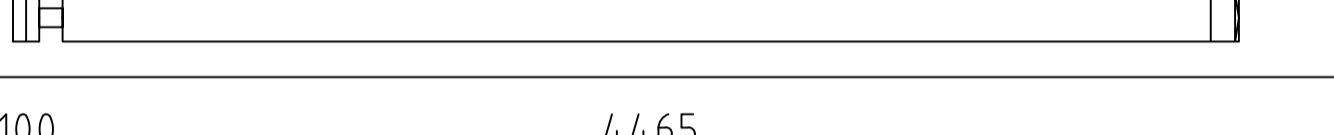
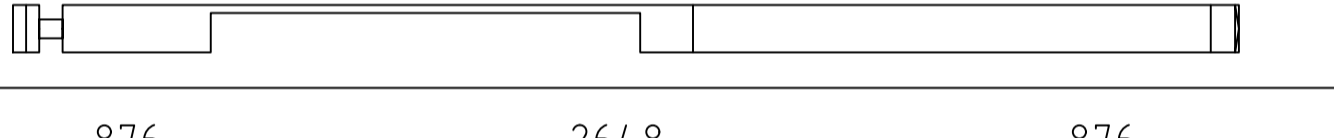
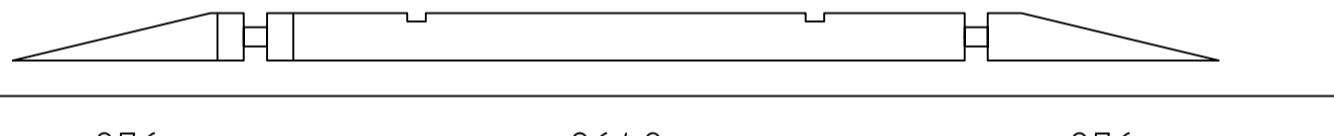
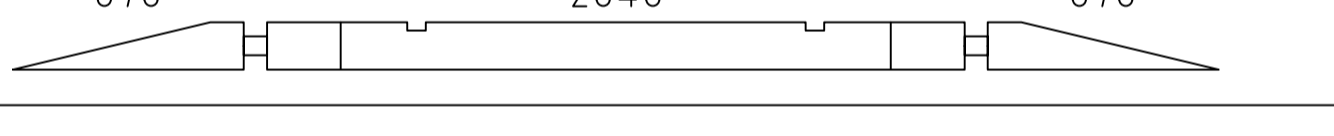
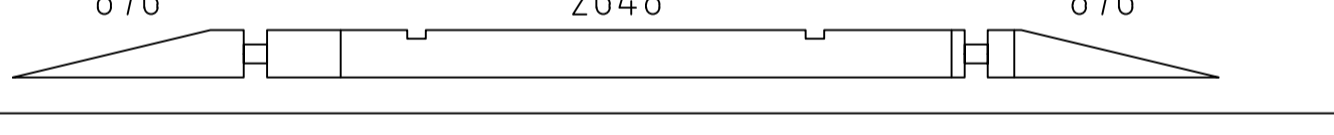
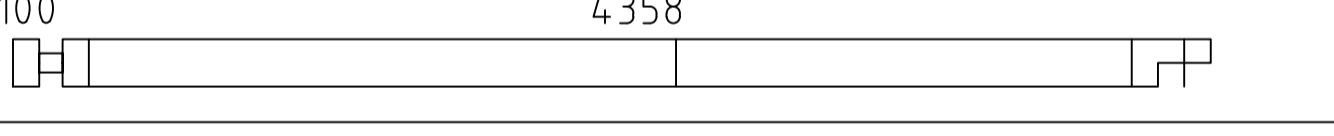
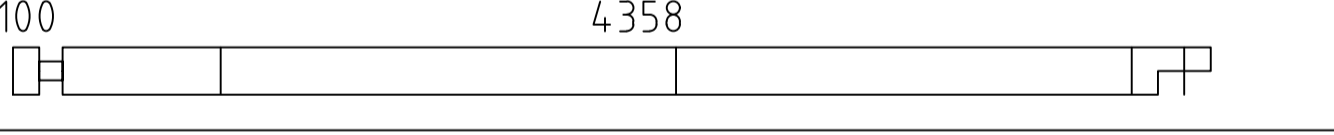
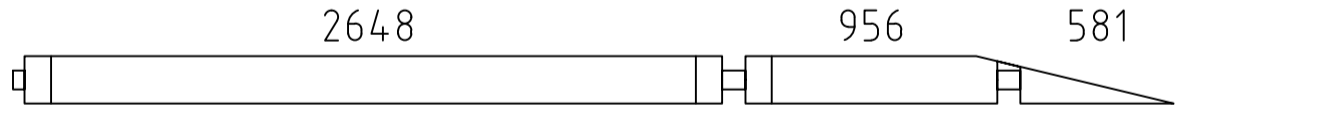
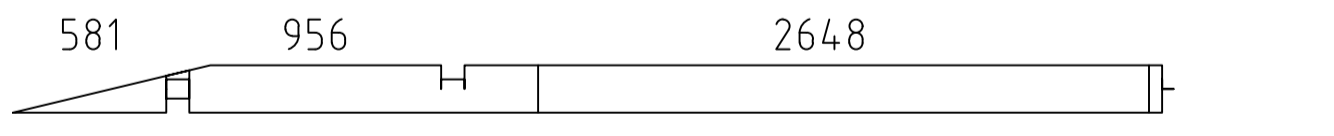
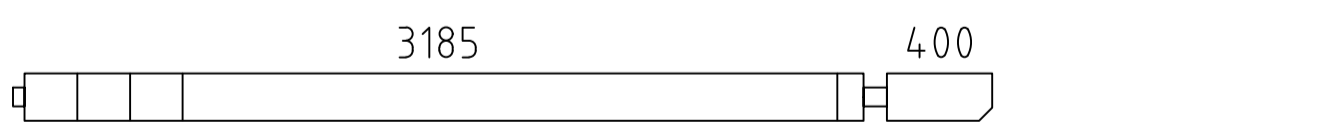
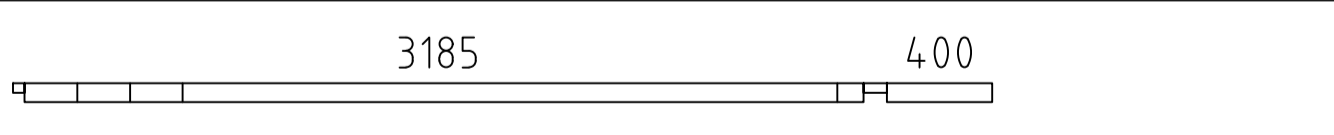
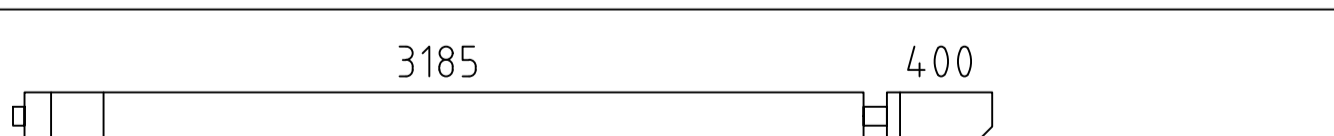
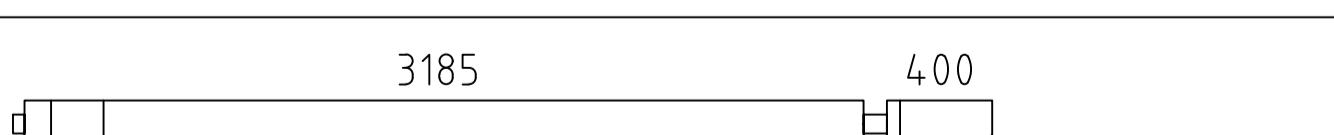
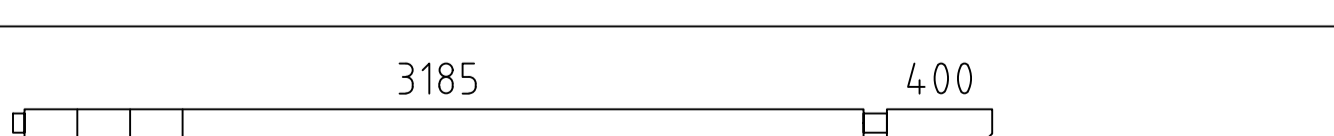

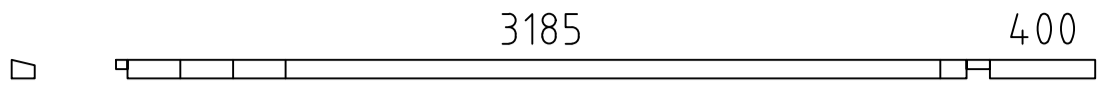
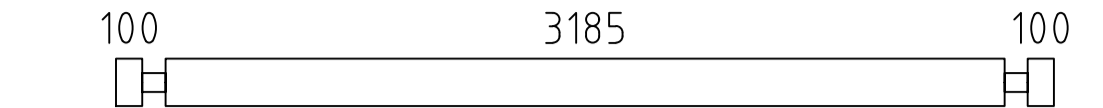
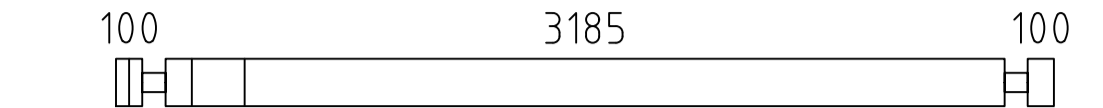
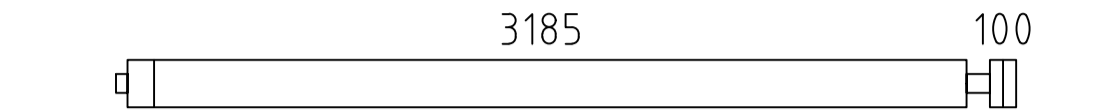
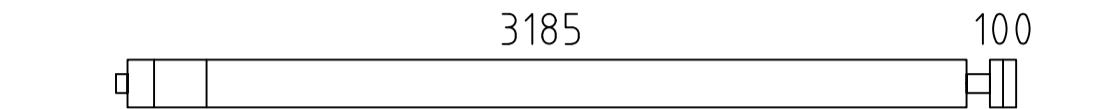
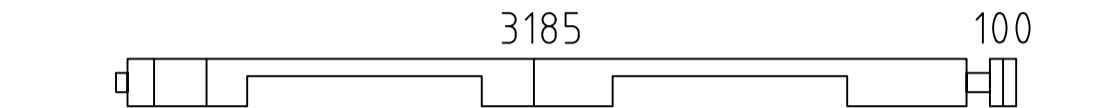
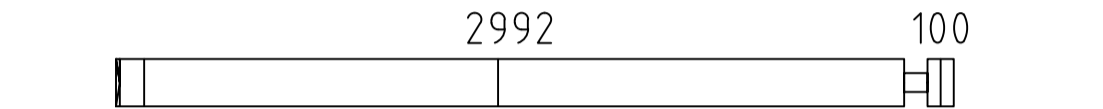
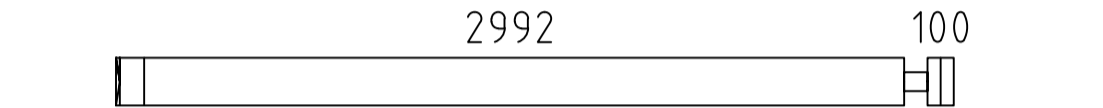
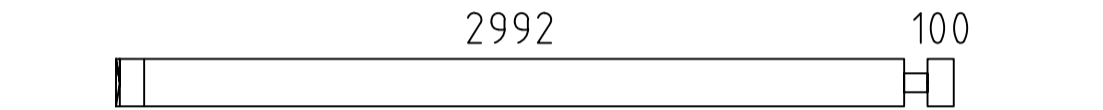
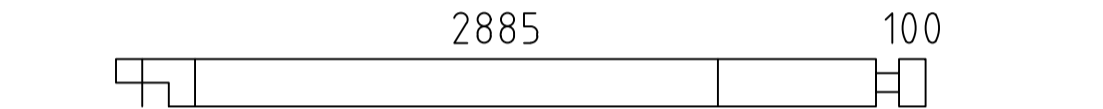
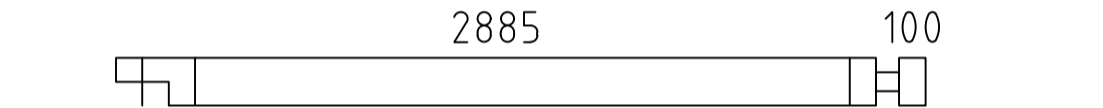
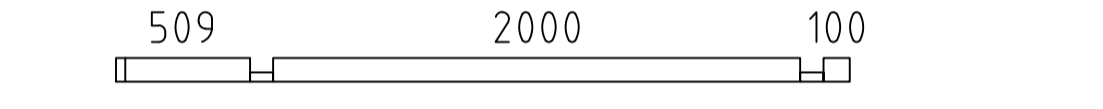
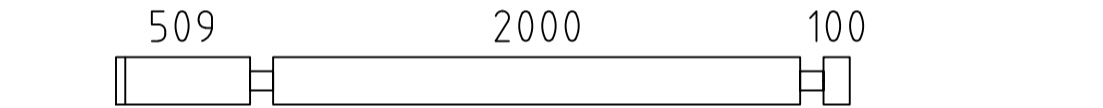
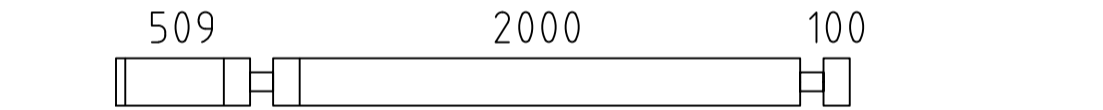
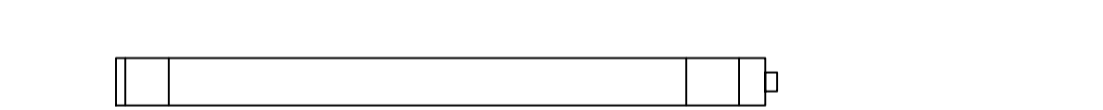
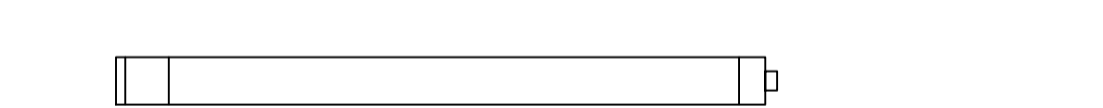
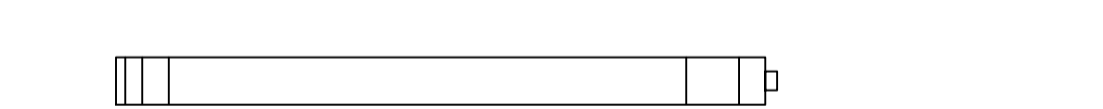
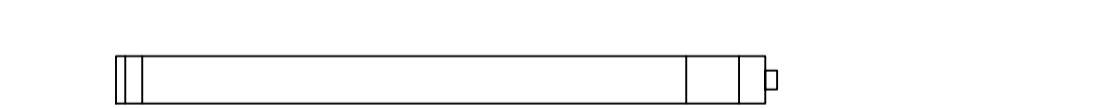
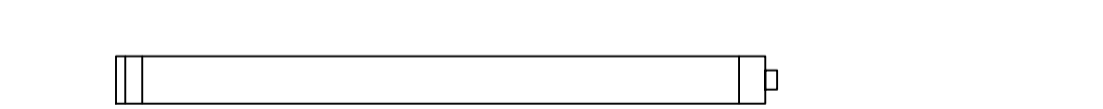
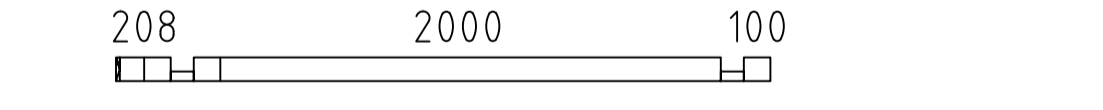
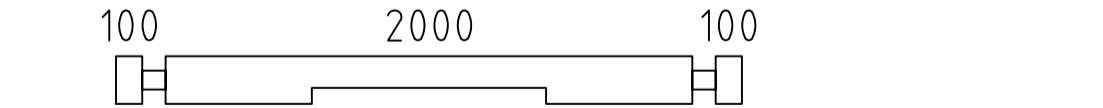
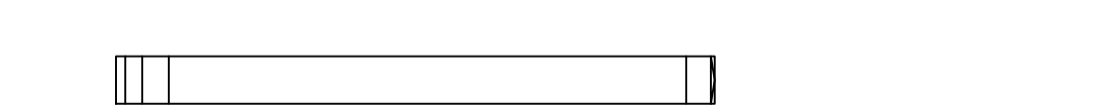
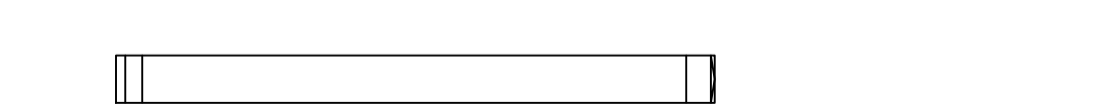
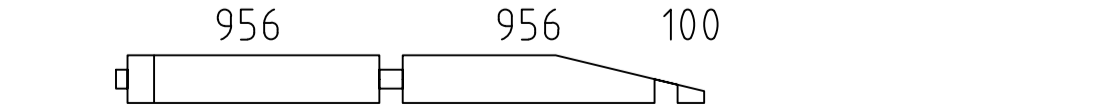
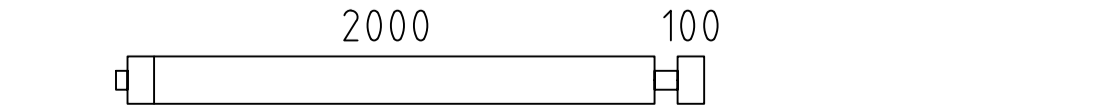

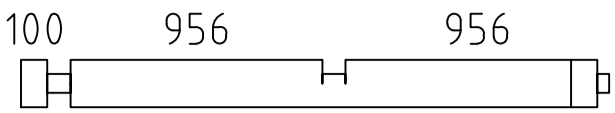
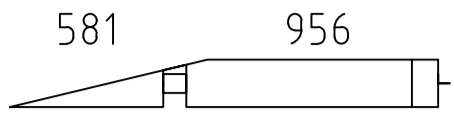
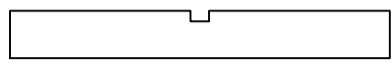
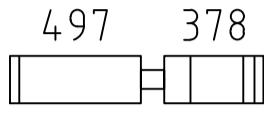
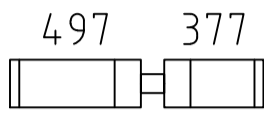
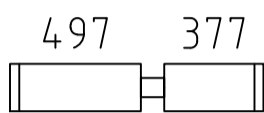
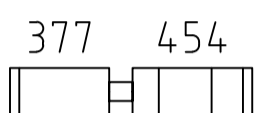
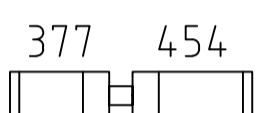
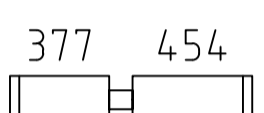
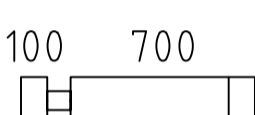
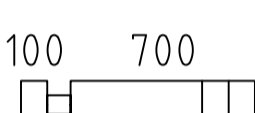
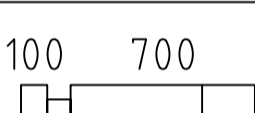
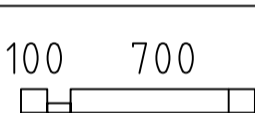
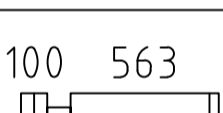
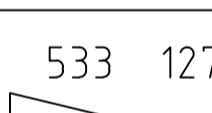
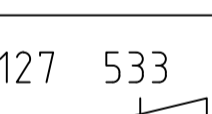

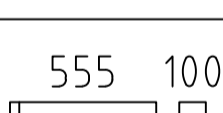
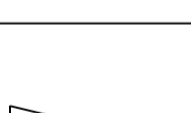
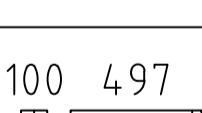
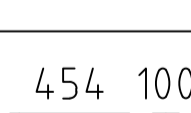
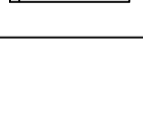
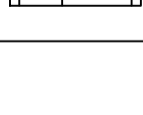
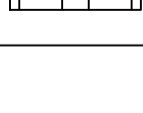
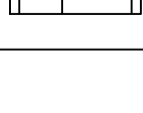

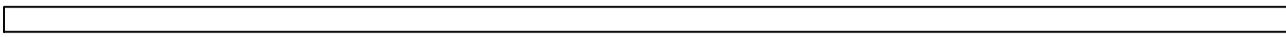
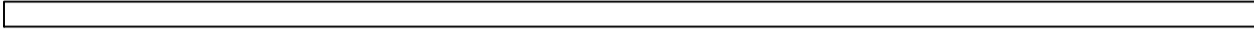
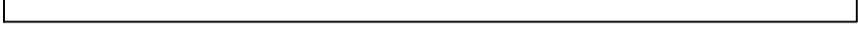

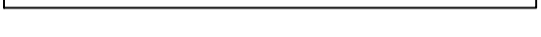
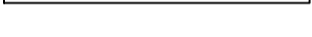



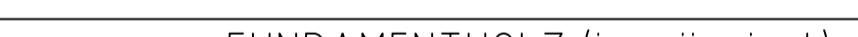
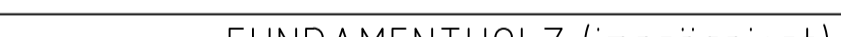

Name	Conference Room 720x1420 88		
Zeichnung/Drawing	WAND/WALL 5		
Profil/Profile	8.8x18	Datum/Date	20.04.2023

Pos	Teieliste/Specification Conference Room 720x1420 88	Stck Pcs.	Profil Profile (mm)	Länge Length (mm)
	Achtung! Die Giebelbohlen können teilweise schon vormontiert sein! Bitte beachten - diese erscheinen nicht ganz so wie in der Teieliste beschrieben.			
	Notice! The gable pieces can be partly pre-assembled! Please notice - those differ from the description given in the specification list.			
000	 Extra log	1	88x180	7200
001		1	88x180	7200
002		1	88x180	7200
003		1	88x180	7200
004		3	88x180	6982
005		1	88x180	6689
006		1	88x180	6397
007		3	88x180	6145
008		4	88x180	6145
009		1	88x180	6075
010		1	88x180	5909
011		1	88x180	5894
012		1	88x180	5894
013		1	88x142	5894
014		8	88x180	5894
015		2	88x71	5894
016		1	88x180	5894
017		1	88x142	5894
018		1	88x142	5190
019		1	88x142	5190
020		2	88x180	5190
021		1	88x71	5190
022		1	88x71	5190
023		1	88x180	5190
024		1	88x180	5190
025		1	88x180	5141
Kood	Conference Room 720x1420 88	Materjal		Leht 1/9

















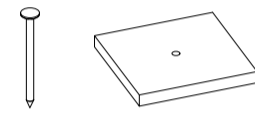
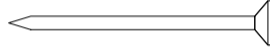
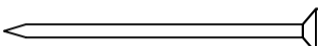

Pos	Teileliste/Specification Conference Room 720x1420 88	Stck Pcs.	Profil Profile (mm)	Länge Length (mm)
026		2	88x180	4968
027		9	88x180	4968
028		2	88x180	4968
029		2	88x180	4968
030		1	88x180	4968
031		1	88x180	4968
032		1	88x180	4968
033		1	88x180	4890
034		1	88x180	4890
035		1	88x90	4732
036		1	88x180	4653
037		1	88x180	4653
038		2	88x180	4576
039		1	88x180	4576
040		1	88x180	4576
041		2	88x180	4546
042		2	88x180	4546
043		2	88x180	4405
044		1	88x180	4405
045		2	88x180	3717
046		1	88x71	3717
047		1	88x180	3717
048		1	88x180	3717
049		1	88x142	3717
050		1	88x142	3717

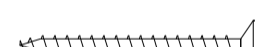

Pos	Teileliste/Specification Conference Room 720x1420 88	Stck Pcs.	Profil Profile (mm)	Länge Length (mm)
051		1	88x71	3717
052		14	88x180	3561
053		1	88x180	3561
054		2	88x180	3417
055		7	88x180	3417
056		1	88x180	3417
057		1	88x180	3180
058		5	88x180	3180
059		1	88x180	3180
060		1	88x180	3073
061		2	88x180	3073
062		2	88x90	2785
063		21	88x180	2785
064		1	88x180	2785
065		2	88x180	2509
066		2	88x180	2509
067		1	88x180	2509
068		3	88x180	2509
069		1	88x180	2509
070		1	88x90	2483
071		1	88x180	2376
072		1	88x180	2272
073		1	88x180	2272
074		3	88x180	2232
075		13	88x180	2232
Kood	Conference Room 720x1420 88	Materjal		Leht 3/9

Pos	Teileliste/Specification Conference Room 720x1420 88	Stck Pcs.	Profil Profile (mm)	Länge Length (mm)
076		2	88x180	2232
077		3	88x180	1669
078		4	88x180	1442
079		2	88x180	962
080		1	88x180	962
081		7	88x180	962
082		2	88x180	919
083		1	88x180	919
084		7	88x180	919
085		39	88x180	888
086		24	88x180	888
087		18	88x180	888
088		3	88x90	888
089		11	88x180	751
090		5	88x180	747
091		3	88x180	747
092		2	88x90	743
093		22	88x180	743
094		8	88x180	685
095		10	88x180	685
096		10	88x180	642
097		32	88x180	497
098		8	88x180	497
099		16	88x180	497
100		4	88x180	497

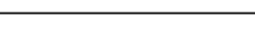
Pos	Teileliste/Specification Conference Room 720x1420 88	Stck Pcs.	Profil Profile (mm)	Länge Length (mm)
FH1	FUNDAMENTHOLZ (imprägniert) - FOUNDATION BEAM (impregnated) 	3	70x95	4871
FH9	FUNDAMENTHOLZ (imprägniert) - FOUNDATION BEAM (impregnated) 	1	70x95	4756
FH22	FUNDAMENTHOLZ (imprägniert) - FOUNDATION BEAM (impregnated) 	1	70x95	3237
FH8	FUNDAMENTHOLZ (imprägniert) - FOUNDATION BEAM (impregnated) 	1	70x95	2251
FH2	FUNDAMENTHOLZ (imprägniert) - FOUNDATION BEAM (impregnated) 	2	70x95	2110
FH6	FUNDAMENTHOLZ (imprägniert) - FOUNDATION BEAM (impregnated) 	2	70x95	2020
FH21	FUNDAMENTHOLZ (imprägniert) - FOUNDATION BEAM (impregnated) 	2	70x95	1160
FH7	FUNDAMENTHOLZ (imprägniert) - FOUNDATION BEAM (impregnated) 	3	70x95	763
FH15	FUNDAMENTHOLZ (imprägniert) - FOUNDATION BEAM (impregnated) 	2	45x95	5894
FH20	FUNDAMENTHOLZ (imprägniert) - FOUNDATION BEAM (impregnated) 	1	45x95	5824
FH18	FUNDAMENTHOLZ (imprägniert) - FOUNDATION BEAM (impregnated) 	2	45x95	5754
FH5	FUNDAMENTHOLZ (imprägniert) - FOUNDATION BEAM (impregnated) 	15	45x95	4781
FH10	FUNDAMENTHOLZ (imprägniert) - FOUNDATION BEAM (impregnated) 	4	45x95	4710
FH14	FUNDAMENTHOLZ (imprägniert) - FOUNDATION BEAM (impregnated) 	2	45x95	4710
FH17	FUNDAMENTHOLZ (imprägniert) - FOUNDATION BEAM (impregnated) 	3	45x95	4640
FH16	FUNDAMENTHOLZ (imprägniert) - FOUNDATION BEAM (impregnated) 	3	45x95	3237
FH19	FUNDAMENTHOLZ (imprägniert) - FOUNDATION BEAM (impregnated) 	1	45x95	3167
FH25	FUNDAMENTHOLZ (imprägniert) - FOUNDATION BEAM (impregnated) 	1	45x95	3122
FH12	FUNDAMENTHOLZ (imprägniert) - FOUNDATION BEAM (impregnated) 	2	45x95	2634
FH4	FUNDAMENTHOLZ (imprägniert) - FOUNDATION BEAM (impregnated) 	2	45x95	2621
FH13	FUNDAMENTHOLZ (imprägniert) - FOUNDATION BEAM (impregnated) 	1	45x95	2032
FH11	FUNDAMENTHOLZ (imprägniert) - FOUNDATION BEAM (impregnated) 	1	45x95	1987
FH3	FUNDAMENTHOLZ (imprägniert) - FOUNDATION BEAM (impregnated) 	25	45x95	1974
FH23	FUNDAMENTHOLZ (imprägniert) - FOUNDATION BEAM (impregnated) 	1	45x95	1160
FH24	FUNDAMENTHOLZ (imprägniert) - FOUNDATION BEAM (impregnated) 	2	45x95	1056
Kood	Conference Room 720x1420 88	Materjal		Leht 5/9

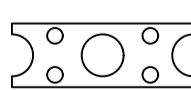
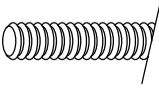
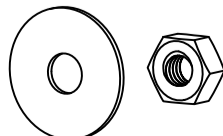
Pos	Teileliste/Specification Conference Room 720x1420 88		Stck Pcs.	Profil Profile (mm)	Länge Length (mm)	
PF5		PFETTEN - PURLINS 800 5506	1	80x280	6394	
PF2		PFETTEN - PURLINS 800 5506	1	80x280	6394	
PF8		PFETTEN - PURLINS 800 5506	1	80x280	6394	
PF4		PFETTEN - PURLINS 400 800	1	80x280	6034	
PF1		PFETTEN - PURLINS 400 4358	1	80x280	4846	
PF7		PFETTEN - PURLINS 400 4358	1	80x280	4846	
PF3		PFETTEN - PURLINS 800 3185 400	1	80x280	4561	
PF9		PFETTEN - PURLINS 800 3185 400	1	80x280	4561	
PF6		PFETTEN - PURLINS 2885 400	1	80x280	3373	
	DACHBRETTEN - ROOF BOARDS		262+5	113x18	4011	
	FUSSBODENBRETTEN - FLOOR BOARDS		✓	113x28	840,0 lfm/rm	
	FUSSBODENBRETTEN - FLOOR BOARDS		17	113x28	3180	
	DECKENLEISTEN - CEILING STRIPS		✓	15x28	83,0 lfm/rm	
	FUSSBODENLEISTEN - FLOOR STRIPS		✓	14x55	57,0 lfm/rm	
G02-1	GIEBELBRETTEN - GABLE BOARDS 18x120	13,5°	✓	4	18x120	4091
G01-1	GIEBELBRETTEN - GABLE BOARDS 18x95	13,5°	✓	4	18x95	4091
G06-1	GIEBELDECKLEISTEN - GABLE COVER STRIPS 18x58		✓	4	18x58	4091
G08-1	GIEBELLEISTEN - GABLE STRIPS 18x58	13,5°	✓	4	18x58	4091
T01-1	TRAUFBRETTEN - EAVES BOARDS 18x95			6	18x95	4933
T06-1	TRAUFNLEISTEN - EAVES STRIPS 18x40		✓		18x40	30,0 lfm/rm
GS	GIEBELSEGMENT - GABLE DIAMOND		2			
TL70-1	T-LEISTEN - T-STRIPS 70		18	45x70	1740	
TL70-2	T-LEISTEN - T-STRIPS 70		2	45x70	1930	
TL70-3	T-LEISTEN - T-STRIPS 70		4	45x70	2020	
SH	SCHLAGHÖLZER - MOUNTING PIECES		3			
Kood	Conference Room 720x1420 88	Materjal		Leht	6/9	

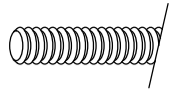
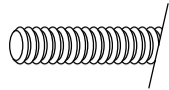
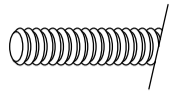
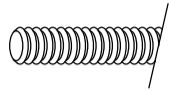
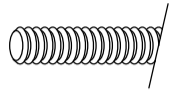
Pos	Teileliste/Specification Conference Room 720x1420 88		Stck Pcs.	Profil Profile (mm)	Länge Length (mm)
ML1	Metallstange - Metal bar		39	D18	1220
ML2	Metallstange - Metal bar		10	D18	1040
ML3	Metallstange - Metal bar		4	D18	860
ML4	Metallstange - Metal bar		6	D18	680
ML5	Metallstange - Metal bar		8	D18	590
ML6	Metallstange - Metal bar		9	D18	500
ML7	Metallstange - Metal bar		3	D18	460
KN01	die Fliese mit Nagel 2.0x40 (für Zapfenfüllung) - A tile with a nail 2.0x40 (to support a tenon)		7		
NG2 550	NÄGEL - NAILS 2.5x50 Dachbretter - Roof boards		2620		
NG2 560	NÄGEL - NAILS 2.5x60 Fussbodenbretter - Floor boards		3654		
SR3 030	Schrauben - Screws 3.0x30 Deckenleisten - Ceiling strips		166		
SR3 030	Schrauben - Screws 3.0x30 Fussbodenleisten - Floor strips		114		
SR3 030	Schrauben - Screws 3.0x30 Traufenleisten - Eaves strips		60		
SR37	Schrauben - Screws 3.5x45 Fenster/Türleisten - Window/Door strips		330		
SR3 545	Schrauben - Screws 3.5x45 Giebelbretter - Gable boards		80		
SR3 545	Schrauben - Screws 3.5x45 Giebeldeckleisten - Gable cover strips		40		
SR3 545	Schrauben - Screws 3.5x45 Giebelleisten - Gable strips		40		
SR3 545	Schrauben - Screws 3.5x45 Giebelsegment - Gable diamond		4		
SR3 545	Schrauben - Screws 3.5x45 Traufenbretter - Eaves boards		72		
SR354 5-001	Schrauben - Screws 3.5x45 Verbindungsstreifen - Connecting strip		232		
SR44	Schrauben - Screws 4.0x60 Wasserleisten - Reinstrips WL1		35		
SR5 0100	Schrauben - Screws 5.0x100 Fundamenthölzer - Foundation beams		332		
VS	Verbindungsstreifen für verbinden der Wandbohlen - Connecting strip for connecting the wall parts		58		
KL-1	Gewindestange - Threaded rod M12- für die Pfetten - for purlins		12		280
MUT28	Mutter - Nut M12 U-Scheibe - Washer Ø40- für die Pfetten - for purlins		24		
Kood	Conference Room 720x1420 88		Materjal		Leht 7/9

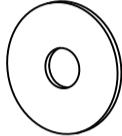
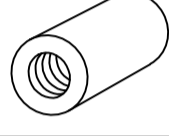
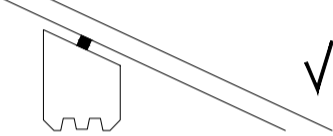
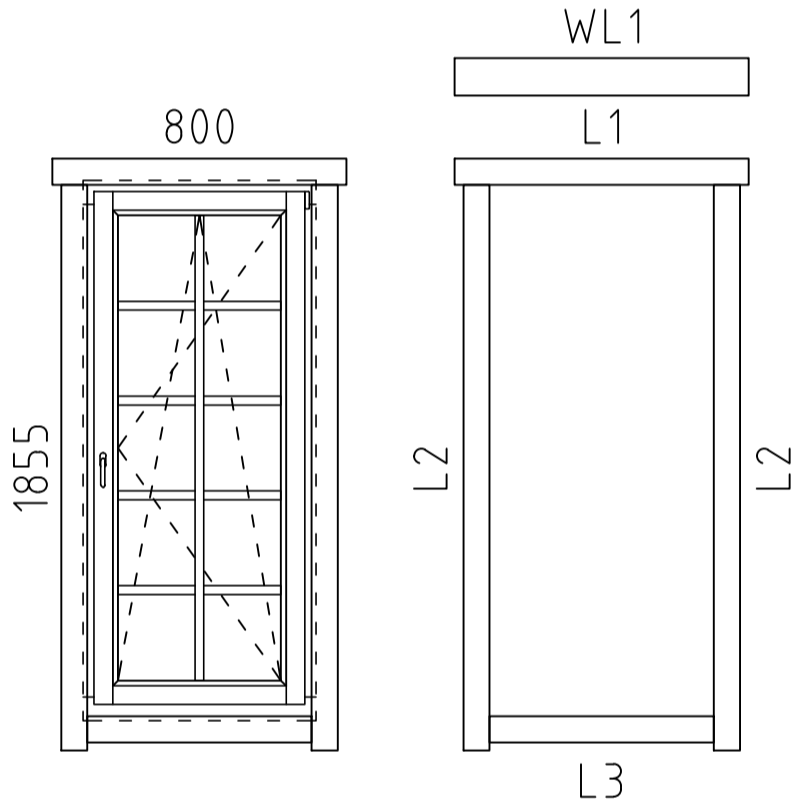
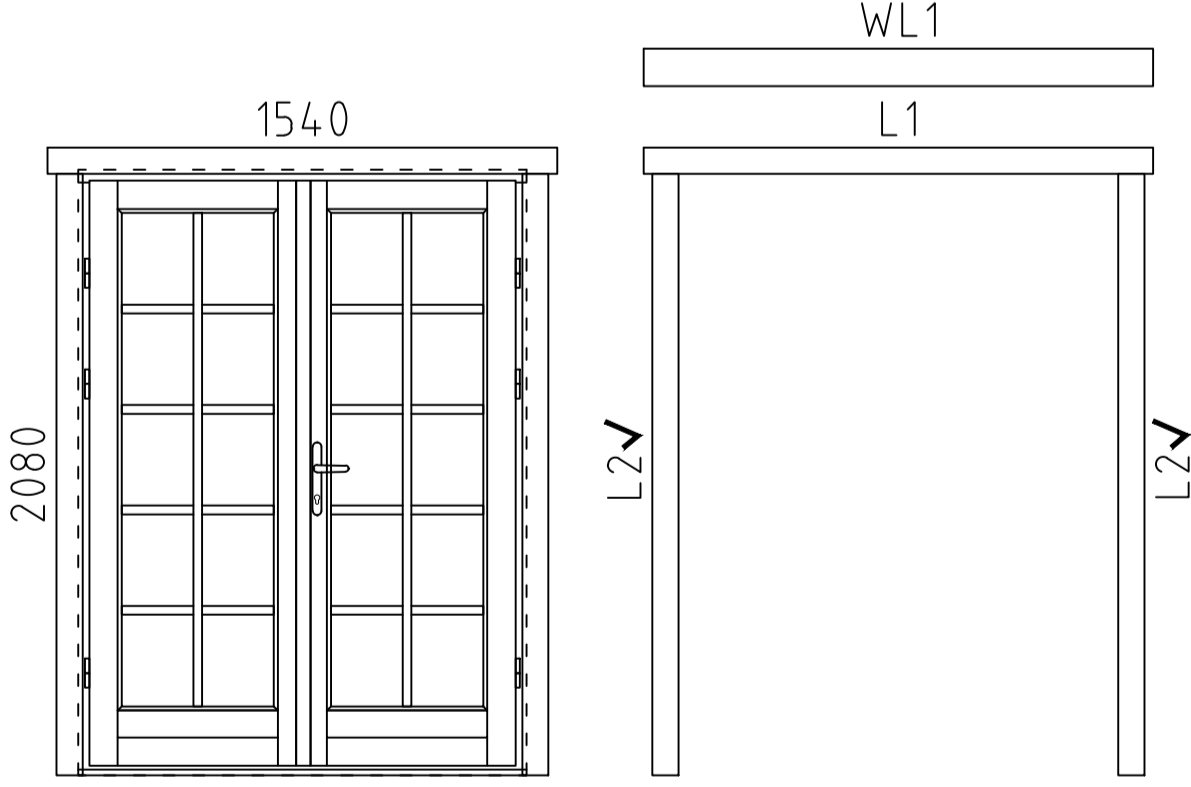
Pos	Teileliste/Specification Conference Room 720x1420 88		Stck Pcs.	Profil Profile (mm)	Länge Length (mm)																				
KL1	Gewindestange - Threaded Rod M12		4		2000																				
KL2	Gewindestange - Threaded Rod M12		3		900																				
KL3	Gewindestange - Threaded Rod M12		4		550																				
KL4	Gewindestange - Threaded Rod M12		24		431																				
KL5	Gewindestange - Threaded Rod M12		16		322																				
KV MU T M12	Mutter - Nut M12		94																						
KV S EIB M12X40	U-Scheibe - Washer M12 Ø40		94																						
KV MU TJ M12	Befestigungsmutter - Fixing nut M12		4																						
DBA ND-1	DICHTUNGSBAND (letzte Bohlenkranz Seitenwänder) - SEAL TAPE (upper log on sidewalls)				30,0 lfm/rm																				
	<p>FENSTER/WINDOW Q6 W6-S88P-01T-08001855</p>  <p>W122-PT</p> <table border="0"> <tr> <td>L1</td> <td>18x90</td> <td>L=1010mm</td> <td>2x</td> <td></td> </tr> <tr> <td>L2</td> <td>18x90</td> <td>L=1940mm</td> <td>4x</td> <td></td> </tr> <tr> <td>L3</td> <td>18x90</td> <td>L=770mm</td> <td>2x</td> <td>✓</td> </tr> <tr> <td>WL1</td> <td>36x129</td> <td>L=1010mm</td> <td>1x</td> <td></td> </tr> </table>		L1	18x90	L=1010mm	2x		L2	18x90	L=1940mm	4x		L3	18x90	L=770mm	2x	✓	WL1	36x129	L=1010mm	1x		9		
L1	18x90	L=1010mm	2x																						
L2	18x90	L=1940mm	4x																						
L3	18x90	L=770mm	2x	✓																					
WL1	36x129	L=1010mm	1x																						
	<p>TÜR/DOOR Q6 D6-D88R-01T-15402080</p>  <p>D202-RT</p> <table border="0"> <tr> <td>L1</td> <td>18x90</td> <td>L=1750mm</td> <td>2x</td> <td></td> </tr> <tr> <td>L2</td> <td>18x90</td> <td>L=2065mm</td> <td>4x</td> <td>✓</td> </tr> <tr> <td>WL1</td> <td>36x129</td> <td>L=1750mm</td> <td>1x</td> <td></td> </tr> </table> <p>DIN rechts/right handed</p>		L1	18x90	L=1750mm	2x		L2	18x90	L=2065mm	4x	✓	WL1	36x129	L=1750mm	1x		2							
L1	18x90	L=1750mm	2x																						
L2	18x90	L=2065mm	4x	✓																					
WL1	36x129	L=1750mm	1x																						
Kood	Conference Room 720x1420 88		Materjal		Leht 8/9																				

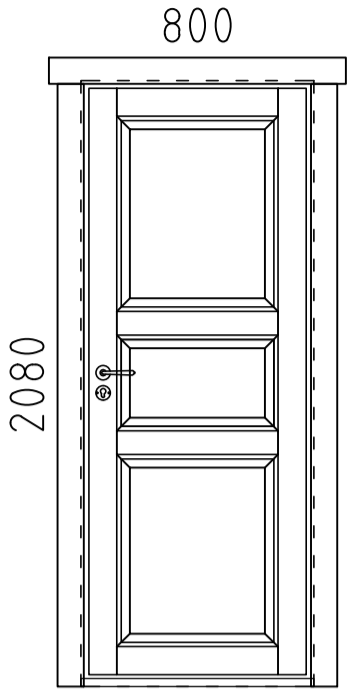
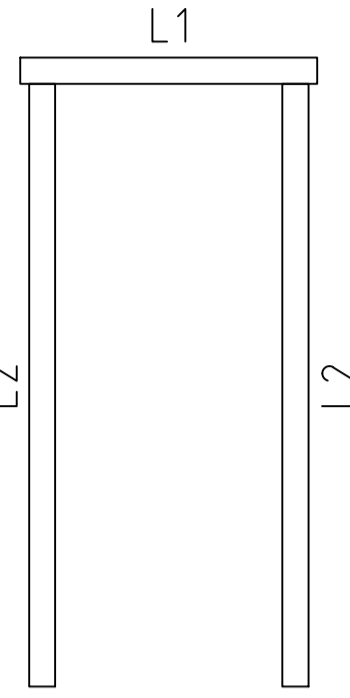
Pos	Teileliste/Specification Conference Room 720x1420 88	Stck Pcs.	Profil Profile (mm)	Länge Length (mm)
	<p style="text-align: center;">TÜR/DOOR Q0 D0-I88R-XXX-08002080</p> <div style="display: flex; align-items: center; justify-content: center;"> <div style="text-align: center; margin-right: 20px;">  </div> <div style="text-align: center; margin-right: 20px;">  </div> <div style="margin-left: 20px;"> <p>D913-RX</p> <p>L1 18x90 L=1020mm 2x</p> <p>L2 18x90 L=2070mm 4x ✓</p> <p>DIN rechts/right handed</p> </div> </div>	1		
	<p>✓ - Bitte selber anpassen (falls nötig)! / Cut into length on site (if needed)!</p>			
Kood	Conference Room 720x1420 88	Materjal		Leht 9/9

Montageanleitung für T-Leisten / Installing the door and window supports / Tenderliistu paigaldusjuhend.

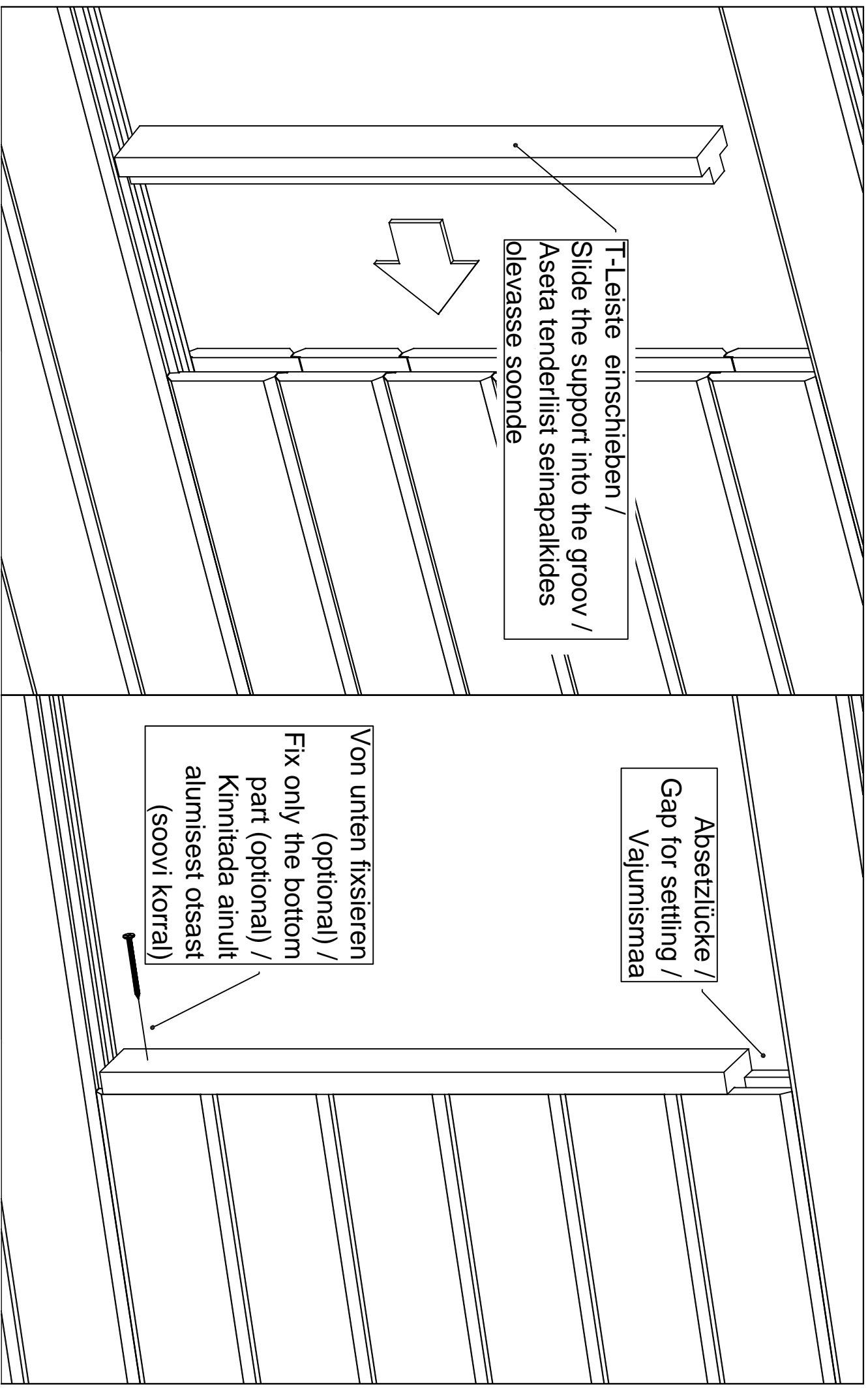

Aken	Q4-Q6	-	paigaldusjuhis
Window	Q4-Q6	-	assembly instructions
Fenster	Q4-Q6	-	Montageanleitung

5-10mm

3.5x45

Lõika mõõtu
Cut to length
Absägen
- 10mm / -20mm

NB!

3.5x45

Vihmaliist / Rain strip / Wasserleiste

Q5-Q6

*Silikoon

*Silicon

*Silikon

*Vajumispilu

*Settling gap

*Senkungs spalt

ca 40-50mm

NB!

- Monteerida juhul kui ese on välja toodud maja spetsifikatsioonis!
- Install only if the item is listed in the house specification!
- Nur montieren wenn die Leiste in der Teileliste gezeigt ist!

Veeplekk / Window sill / Fensterbank

4,2x16

Ukse montaaž / Tür montage / Door assembly
(GH+ / SH)

4.5x90

4.5x90

5mm

3.5x45

Vihmaliist / Head flashing / Regenschutz

Silikoon
Silicon
Silikon

Vajumispilu
Settling gap
Senkungs spalt
40-50mm

NB!

- Monteerida juhul kui ese on välja toodud maja spetsifikatsioonis!
- Install only if the item is listed in the house specification!
- Nur montieren wenn die Leiste in der Teilleiste gezeigt ist!