

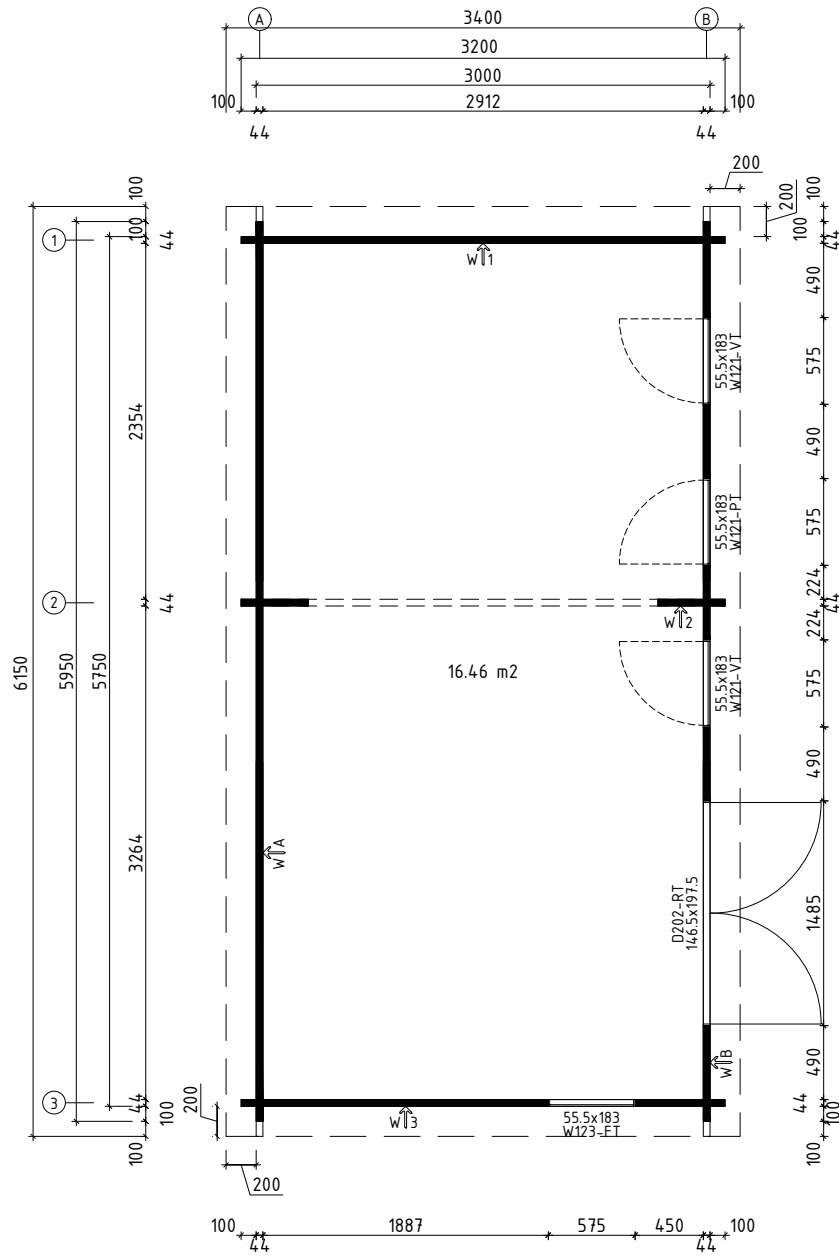



Name	Liam 320x595 44		SKU G0058
Drawing/Zeichnung	3D		Format
Profile/Profil	4.4x13.5	Scale/Maßstab	Date 11.08.2023



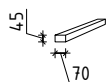
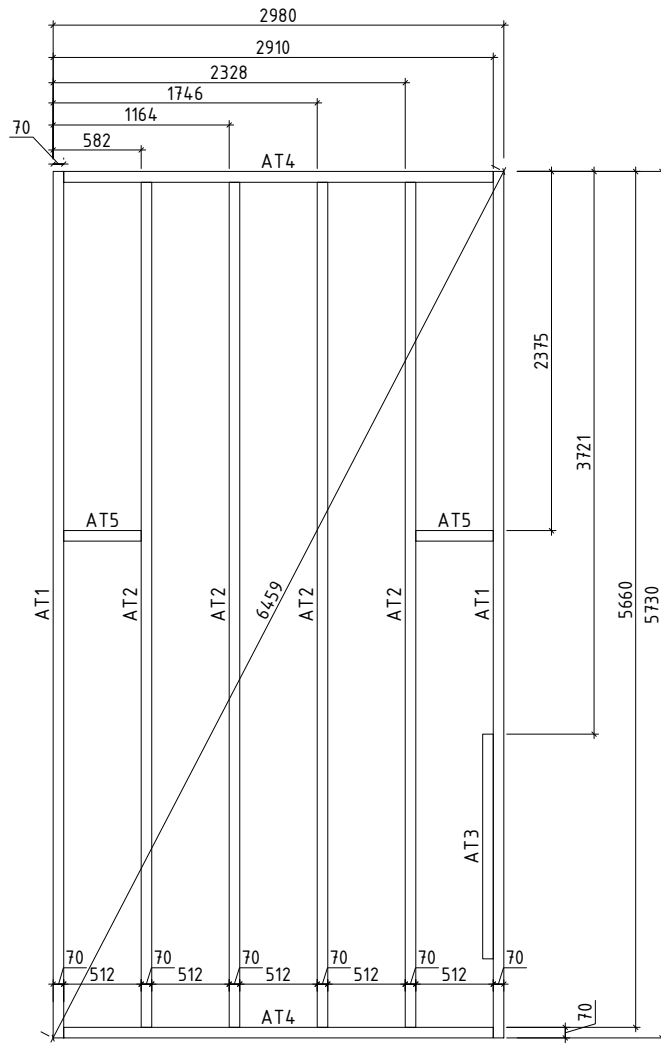

Opening and fixed window positions can be interchanged.  
 Positionen für feststehende Fenster und Fenster zum  
 Öffnen können miteinander getauscht werden.





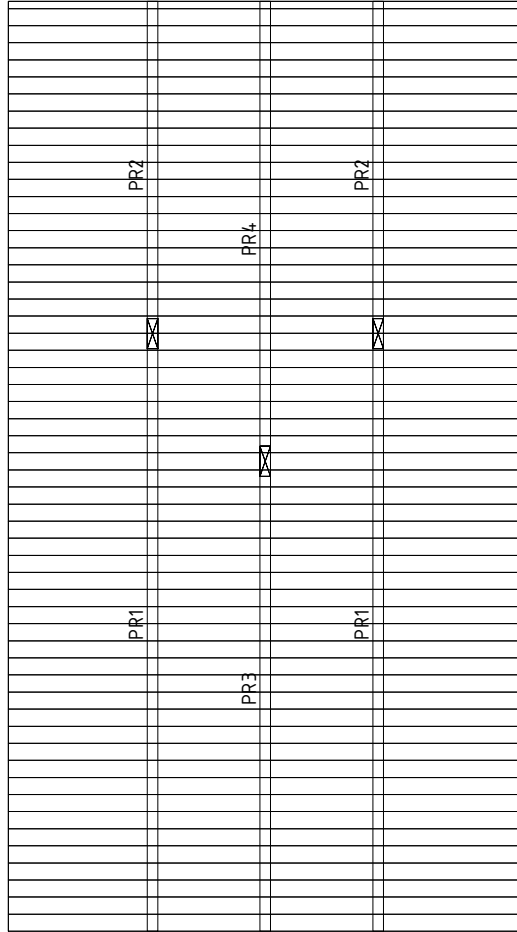





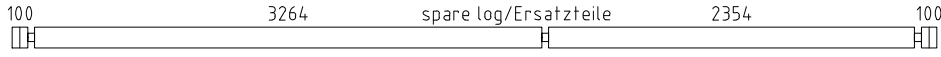
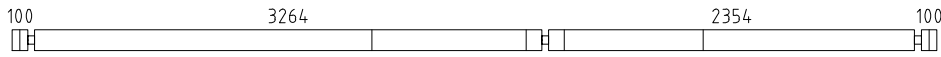
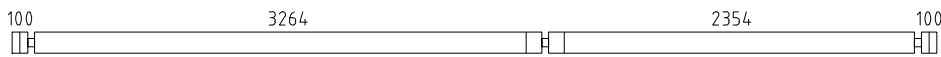

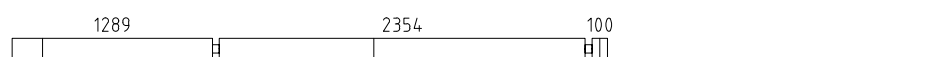

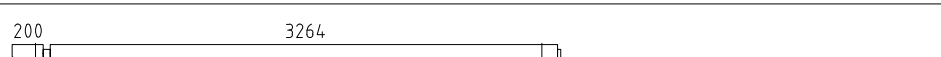
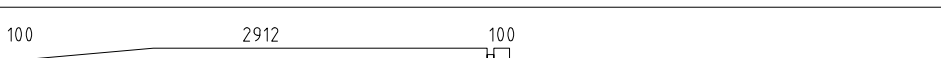
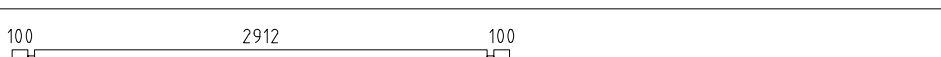
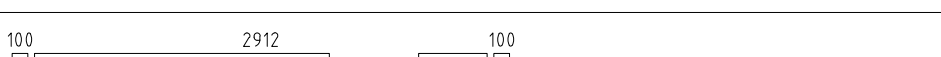
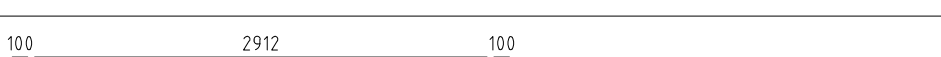

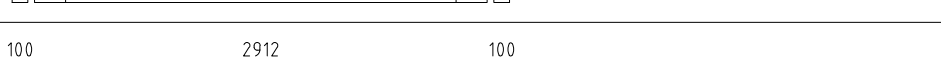
 <a href="http://www.hansa24.com">www.hansa24.com</a>	Name	Liam 320x595 44	SKU	G0058	
	Drawing/Zeichnung	Plan_Grundplan	Format	A4	
	Profile/Profil	4.4x13.5	Scale/Maßstab	1:50	Date

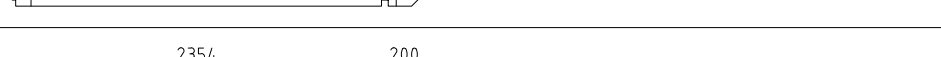

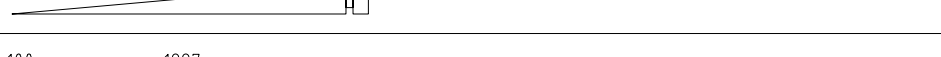













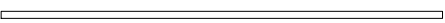

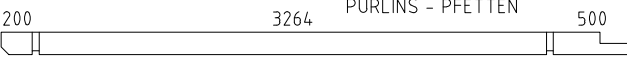
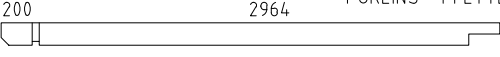
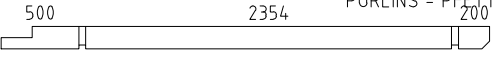
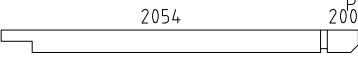
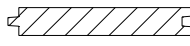
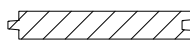

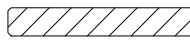
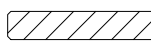

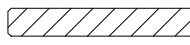

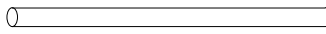
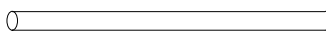

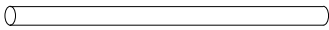
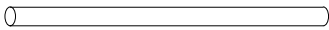
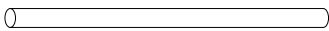

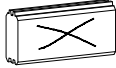
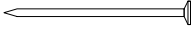









 <a href="http://www.hansa24.com">www.hansa24.com</a>	Name Liam 320x595 44		SKU G0058
	Drawing/Zeichnung Foundation plan_Lagerholzplan		Format A4
	Profile/Profil 4.4x13.5	Scale/Maßstab 1:50	Date 11.08.2023



 <a href="http://www.hansa24.com">www.hansa24.com</a>	Name		Liam 320x595 44	SKU	G0058
	Drawing/Zeichnung		Roof Boards_Dachbretter	Format	A4
	Profile/Profil	4.4x13.5	Scale/Maßstab	1:50	Date

Pos	Model Liam 320x595 44	Pcs	Profile (mm)	Length (mm)
	Notice! The gable pieces can be partly pre-assembled! Please notice - those differ from the description given in the specification list.			
	Achtung! Die Giebelbohlen können teilweise schon vormontiert sein! Bitte beachten - diese erscheinen nicht ganz so wie in der Teilleiste beschrieben.			
003	 spare log/Ersatzteile	1	44x135	5950
001		1	44x135	5950
002		3	44x135	5950
003		13	44x135	5950
004		1	44x135	3831
005		1	44x135	3530
006		1	44x126	3530
007		3	44x135	3200
008		1	44x135	3200
009		1	44x135	3200
010		2	44x68	3200
011		1	44x135	3200
012		15	44x135	3200
013		1	44x126	2620
014		1	44x135	2620
015		3	44x135	2292
016		13	44x135	2041
017		3	44x68	764
018		29	44x135	634
019		13	44x135	584
020		14	44x135	492
021		20	44x135	490
022		8	44x135	490
Kood	Liam 320x595 44	Materjal	File	Leht 1/8





Pos	Model Liam 320x595 44	Pcs	Profile (mm)	Length (mm)
023		14	44x135	444
024		8	44x135	444
025		6	44x135	444
026		2	44x68	444
AT1	FOUNDATION BEAMS (impregnated) - FUNDAMENTHÖLZER (imprägniert) 	2	70x45	5730
AT2	FOUNDATION BEAMS (impregnated) - FUNDAMENTHÖLZER (imprägniert) 	4	70x45	5590
AT4	FOUNDATION BEAMS (impregnated) - FUNDAMENTHÖLZER (imprägniert) 	2	70x45	2840
AT3	FOUNDATION BEAMS (impregnated) - FUNDAMENTHÖLZER (imprägniert) 	1	70x45	1485
AT5	FOUNDATION BEAMS (impregnated) - FUNDAMENTHÖLZER (imprägniert) 	2	70x45	512
PR1	PURLINS - PFETTEN 	2	70x145	4052
PR3	PURLINS - PFETTEN 	1	70x145	3208
PR4	PURLINS - PFETTEN 	1	70x145	3142
PR2	PURLINS - PFETTEN 	2	70x145	2298
	ROOF BOARDS - DACHBRETTER 	55+1	113x18	3413
	FLOOR BOARDS - FUSSBODENBRETTER 	51+1	113x18	2907
	Ceiling mouldings - Deckenleisten (inside and outside - innen und außen) 		15x28	41 rm/lfm
	Floor mouldings - Fussbodenleisten 		18x40	18 rm/lfm
RLA 02-1	Eave board - Traufenbrett 18x120 	2	18x120	3093
RLA 01-1	Eave board - Traufenbrett 18x95 	2	18x95	3075
RKL 01-1	Eave cover slat - Traufendeckleiste 18x40 	2	18x40	3093
RLI01-1	Eave slat - Traufenleiste 18x40 		18x40	13.3 rm/lfm
VLA 02-1	Gable board - Giebelbrett 18x120 	2	18x120	3431
VKL 01-1	Gable cover slat - Giebeldeckleiste 18x40 	2	18x40	3431
ÜV1	Metal bar - Metallstange Ø10 	8	10	900
ÜV2	Metal bar - Metallstange Ø10 	2	10	770
Kood	Liam 320x595 44	Materjal	File	Leht 2/8



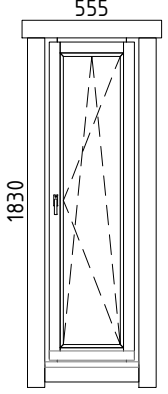

Pos	Model Liam 320x595 44	Pcs	Profile (mm)	Length (mm)
ÜV3	Metal bar - Metallstange Ø10 	2	10	700
ÜV4	Metal bar - Metallstange Ø10 	2	10	360
ÜV1	Metal bar - Metallstange Ø10 	2	Ø10	360
ML01	Connecting strip for wall logs - Verbindungsstreifen für Wandbalken 	2		
LK	Hit block - Schlaghölzer 	3		
N-0 2503	Nails - Nägel 2.5x60 for floor boards - für Fussbodenbretter 	612		
N-0 2501	Nails - Nägel vierkant 2.5x50 for ceiling boards - für Dachbretter 	550		
KR-0 3001	Screws - Schrauben 3.0x30 for ceiling mouldings - für Deckenleisten 	76		
KR-0 3002	Screws - Schrauben 3.0x30 for eave slats - für Traufenleisten 	28		
KR-0 3003	Screws - Schrauben 3.0x30 for floor mouldings - für Fussbodenleisten 	36		
KR-0 3522	Screws - Schrauben 3.5x45 C3 for connecting strip for wall logs - für Verbindungsstreifen für Wandbalken 	8		
KR-0 3525	Screws - Schrauben 3.5x45 C3 for eave boards - für Traufenbretter 	28		
KR-0 3526	Screws - Schrauben 3.5x45 C3 for eave cover slats - für Traufendeckleisten 	14		
KR-0 3527	Screws - Schrauben 3.5x45 C3 for gable boards - für Giebelbretter 	16		
KR-0 3521	Screws - Schrauben 3.5x45 C3 for gable cover slats - für Giebeldeckleisten 	16		
KR-0 5080	Screws - Schrauben 5.0x100 for foundation beams - für Fundamenthölzer 	44		
KL1	Threaded rod - Gewindestange M8 	4		2000
KL2	Threaded rod - Gewindestange M8 	2		460
KL3	Threaded rod - Gewindestange M8 	2		190
KL03-1	Threaded rod for purlins - Gewindestange für die Pfetten M12 	6		150
M03	Nut for purlins - Mutter für die Pfetten M12 	12		
SE32	Washer for purlins - Scheibe für die Pfetten M12x37 	12		
	Nut - Mutter M8 	4		
	Washer - Scheibe M8x24 	4		
	Extended nut - Langmutter M8 	4		
Kood	Liam 320x595 44	Materjal	File	Leht 3/8



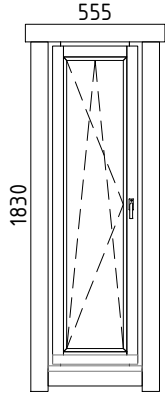

Pos	Model Liam 320x595 44	Pcs	Profile (mm)	Length (mm)
	Drive-in nut - Einschlagmutter M8 	4		
Kood	Liam 320x595 44	Materjal	File	Leht 4/8



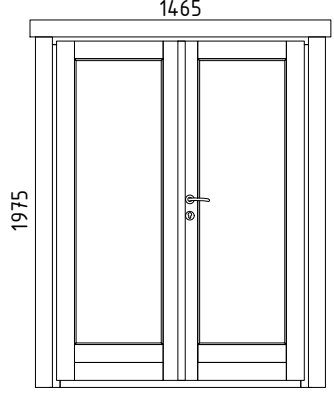

Pos	Model Liam 320x595 44	Pcs	Profile (mm)	Length (mm)	
	WINDOW 555x1830 W5-S44F-0XT-05551830 W123-FT Tempered glass - Gehärtetes Glas Fixed - Fix	1			
VIHM 01-1	Rain deflector - Regenabweiser		1	36x134	755
KR-0 3524	Screws - Schrauben 3.5x45 C3 for door and window trims - für Tür- und Fensterleisten		24		
KR-0 4001	Screws - Schrauben 4.0x60 C3 for rain deflector - für Regenabweiser		2		
Kood	Liam 320x595 44	Materjal	File	Leht	5/8

Pos	Model Liam 320x595 44	Pcs	Profile (mm)	Length (mm)	
	WINDOW 555x1830 W5-S44P-0XT-05551830  W121-PT Right handed - DIN rechts Tempered glass - Gehärtetes Glas Opens inside - Öffnet innen	1			
VIHM 01-1	Rain deflector - Regenabweiser		1	36x134	755
KR-0 3524	Screws - Schrauben 3.5x45 C3 for door and window trims - für Tür- und Fensterleisten		24		
KR-0 4001	Screws - Schrauben 4.0x60 C3 for rain deflector - für Regenabweiser		2		
Kood	Liam 320x595 44	Materjal	File	Leht	6/8

Pos	Model Liam 320x595 44	Pcs	Profile (mm)	Length (mm)	
	WINDOW 555x1830 W5-S44V-0XT-05551830  W121-VT Left handed - DIN links Tempered glass - Gehärtetes Glas Opens inside - Öffnet innen	2			
VIHM 01-1	Rain deflector - Regenabweiser		2	36x134	755
KR-0 3524	Screws - Schrauben 3.5x45 C3 for door and window trims - für Tür- und Fensterleisten		48		
KR-0 4001	Screws - Schrauben 4.0x60 C3 for rain deflector - für Regenabweiser		4		
Kood	Liam 320x595 44	Materjal	File	Leht	7/8

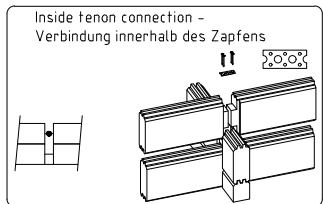
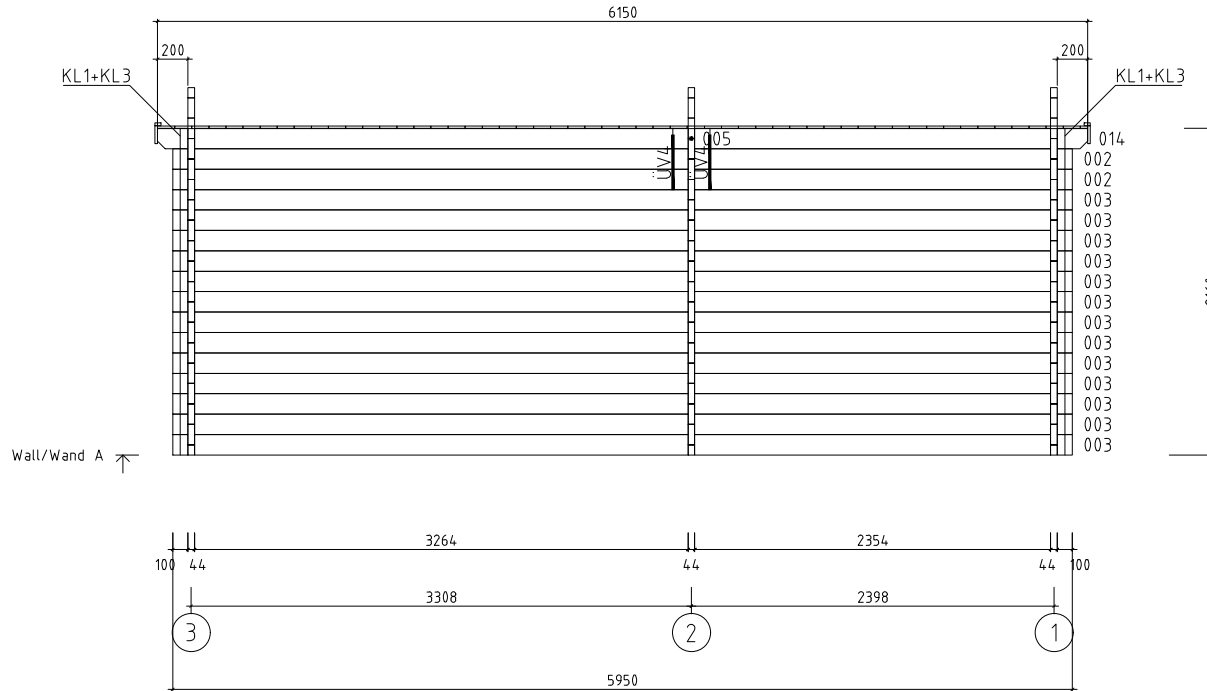
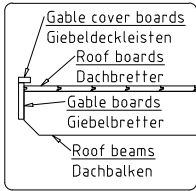
Pos	Model Liam 320x595 44	Pcs	Profile (mm)	Length (mm)	
	DOOR 1465x1975 D5-D44R-0XT-14651975  D202-RT Right handed - DIN rechts Tempered glass - Gehärtetes Glas Opens outside - Öffnet aussen	1			
VIHM 01-2	Rain deflector - Regenabweiser		1	36x134	1665
KR-0 3524	Screws - Schrauben 3.5x45 C3 for door and window trims - für Tür- und Fensterleisten		28		
KR-0 4001	Screws - Schrauben 4.0x60 C3 for rain deflector - für Regenabweiser		4		
Kood	Liam 320x595 44	Materjal	File	Leht	8/8



 <a href="http://www.hansa24.com">www.hansa24.com</a>	Name		Liam 320x595 44		SKU	G0058
	Drawing/Zeichnung		Wall/Wand A		Format	A4
Profile/Profil	4.4x13.5	Scale/Maßstab	1:50	Date	11.08.2023	

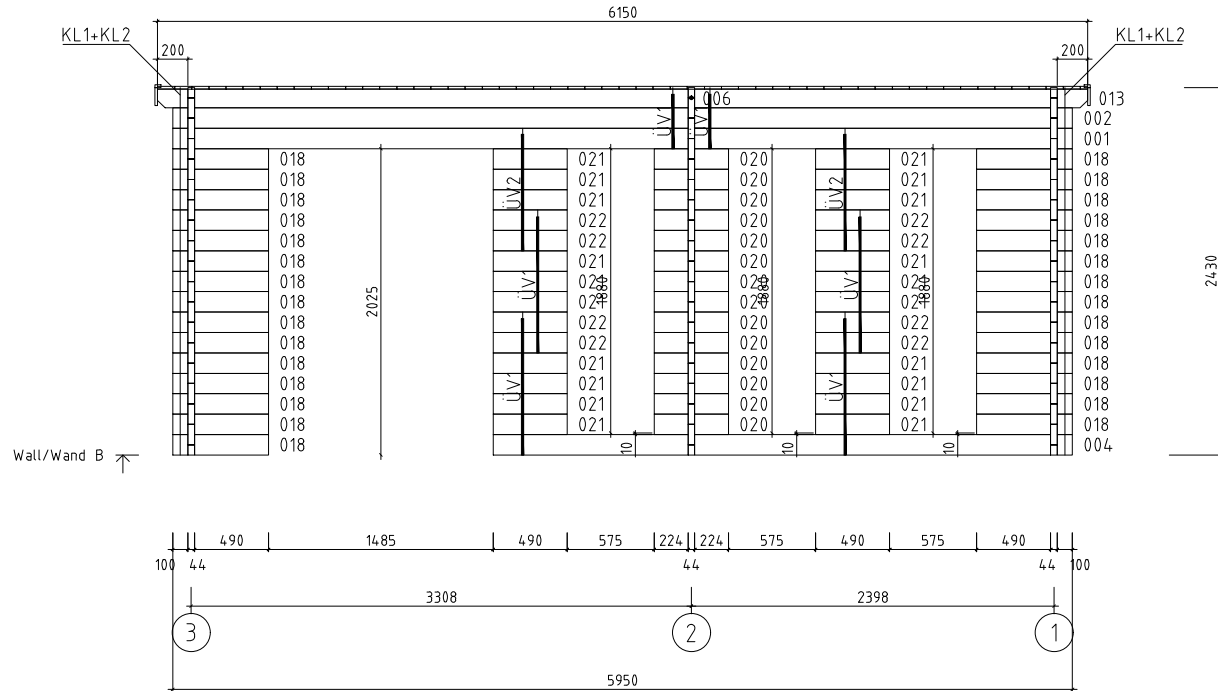

Rain strip / Wasserleiste

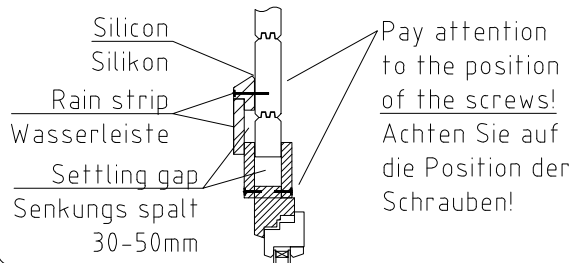

 <a href="http://www.hansa24.com">www.hansa24.com</a>	Name		Liam 320x595 44	SKU	G0058	
	Drawing/Zeichnung			Wall/Wand B	Format	A4
	Profile/Profil	4.4x13.5	Scale/Maßstab	1:50	Date	11.08.2023

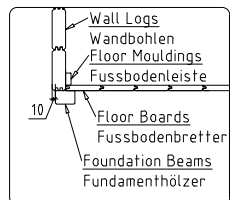
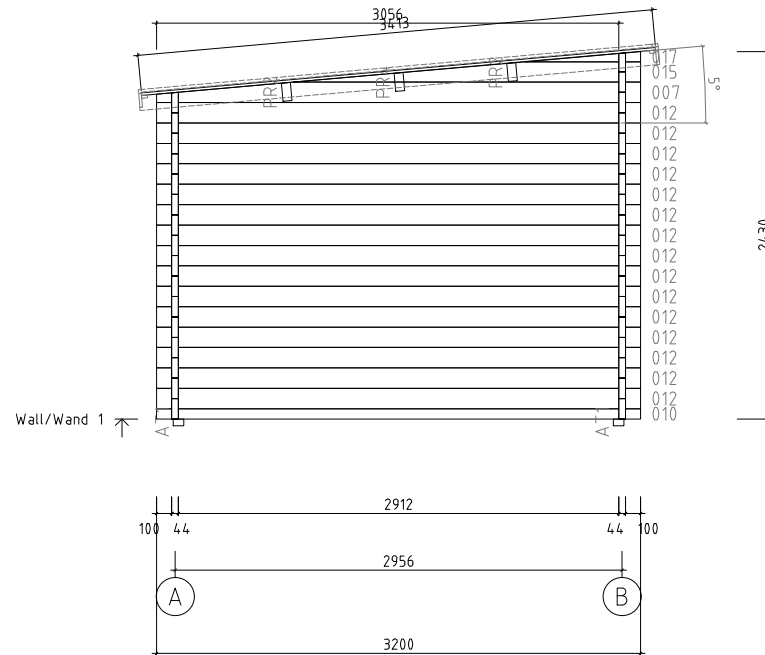
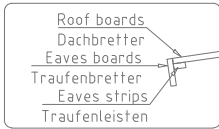
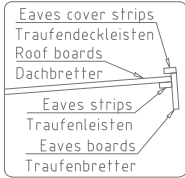

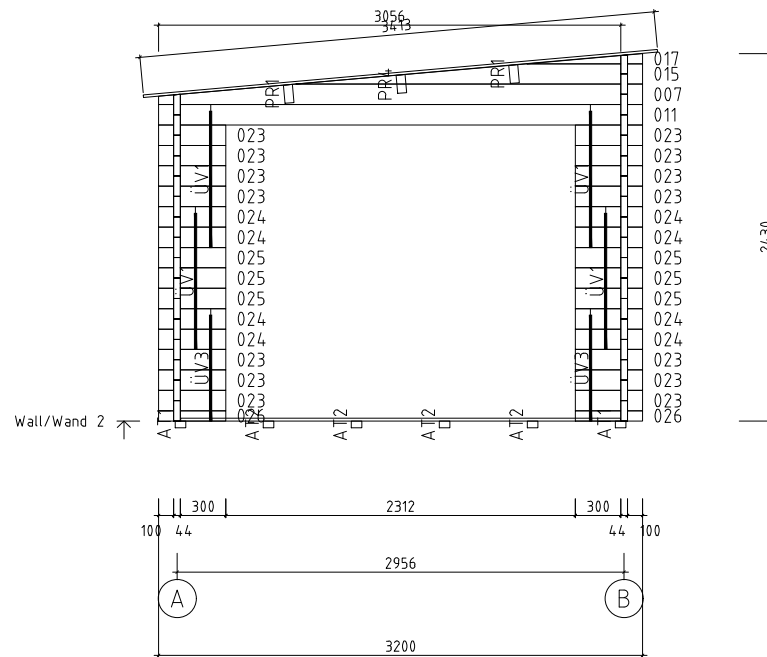

 www.hansa24.com	Name		Liam 320x595 44		SKU	G0058
	Drawing/Zeichnung		Wall/Wand 1		Format	A4
	Profile/Profil	4.4x13.5	Scale/Maßstab	1:50	Date	11.08.2023



 www.hansa24.com	Name		Liam 320x595 44		SKU		G0058
	Drawing/Zeichnung		Wall/Wand 2		Format		A4
	Profile/Profil	4.4x13.5	Scale/Maßstab	1:50	Date	11.08.2023	

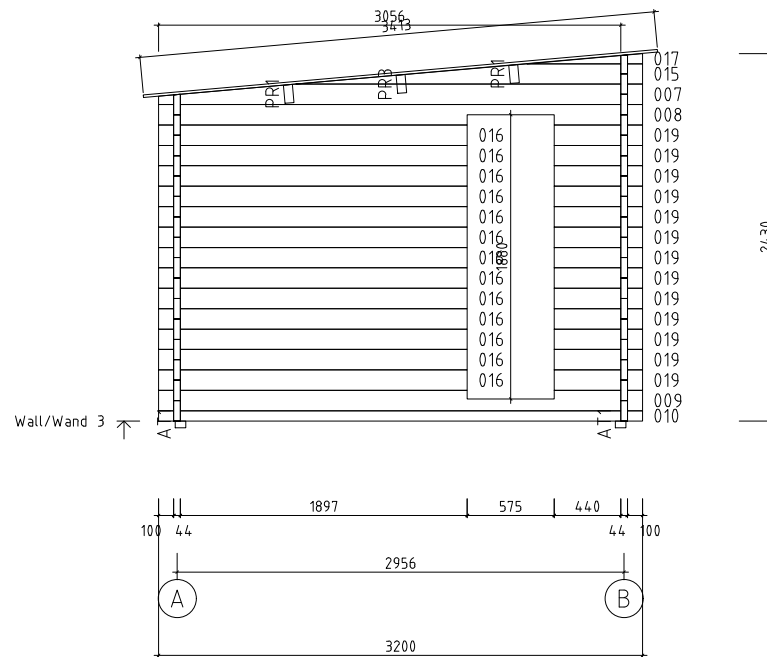



 <a href="http://www.hansa24.com">www.hansa24.com</a>	Name		Liam 320x595 44		SKU	G0058
	Drawing/Zeichnung		Wall/Wand 3		Format	A4
	Profile/Profil	4.4x13.5	Scale/Maßstab	1:50	Date	11.08.2023