

 www.hansa24.com	Name Lucas E 340x320+VK 44		SKU G0157
	Drawing/Zeichnung 3D		Format
	Profile/Profil 4.4x13.5	Scale/Maßstab	Date 18.05.2023

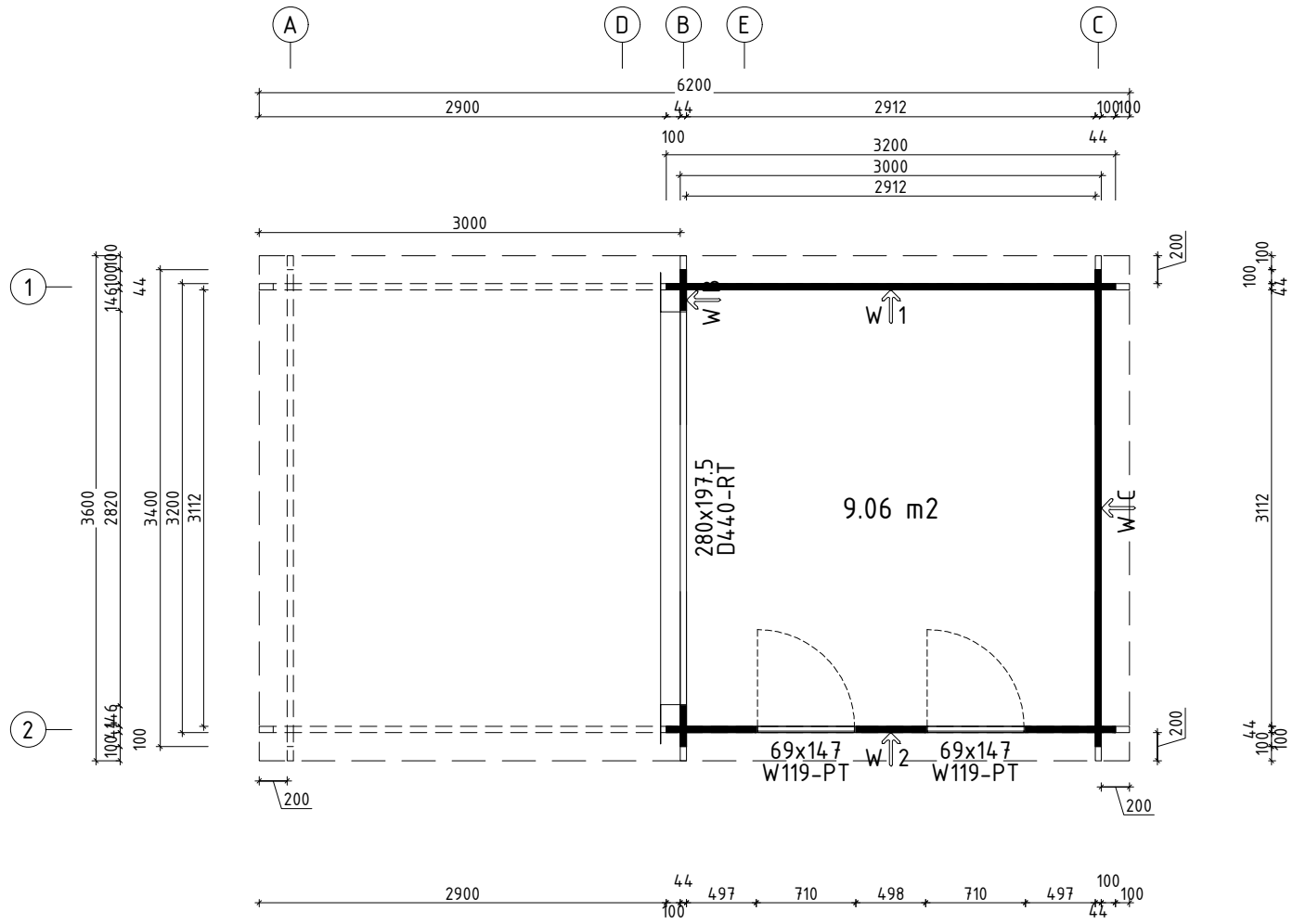

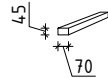

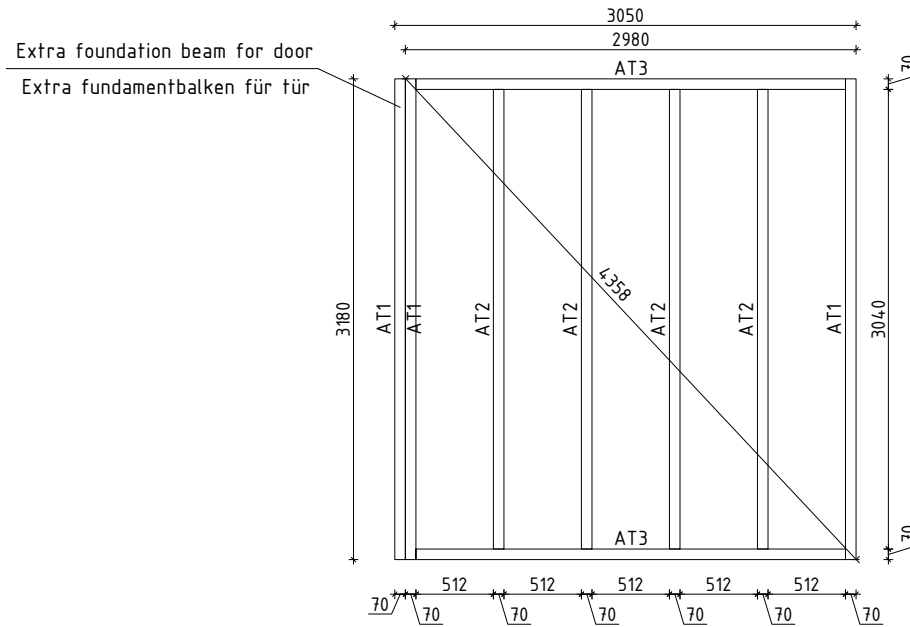



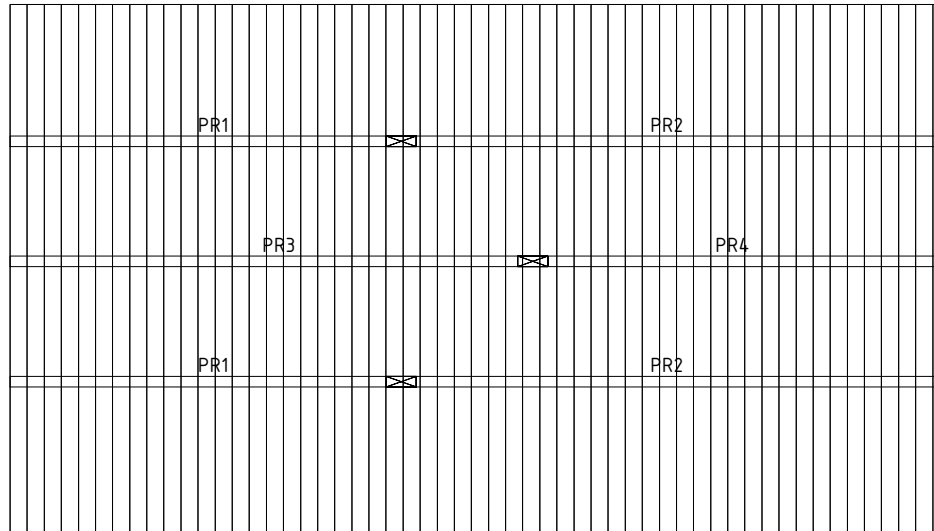

Name	Lucas E 340x320+VK 44	SKU	G0157
Drawing/Zeichnung	Plan_Grundplan	Format	A4
Profile/Profil	4.4x13.5	Scale/Maßstab	1:50
		Date	18.05.2023

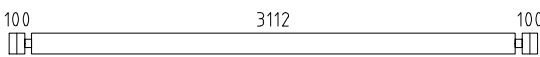
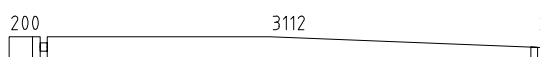
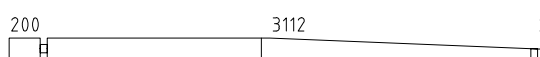

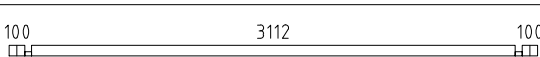
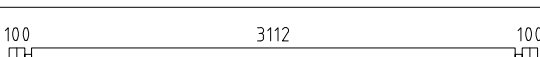
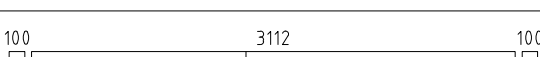
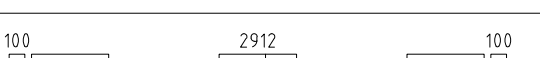

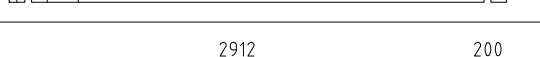
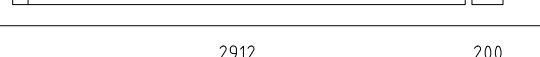
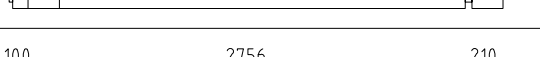
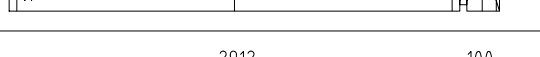
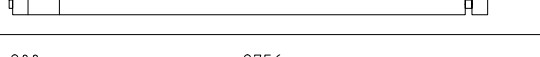

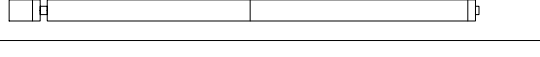
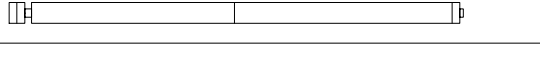
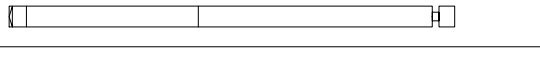
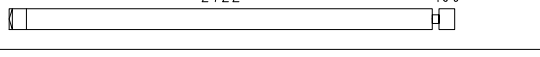
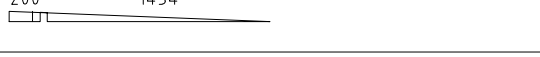
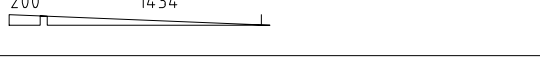









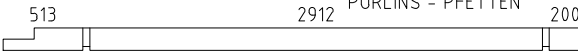
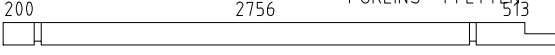
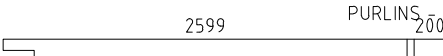
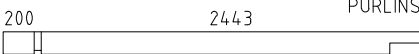
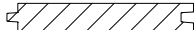



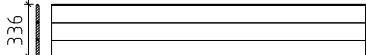
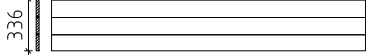
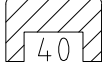

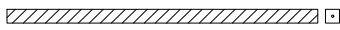
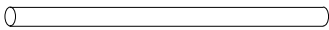
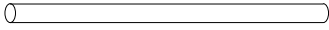



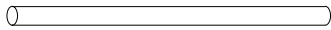
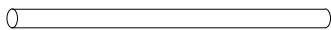

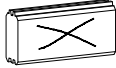
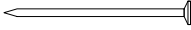







 www.hansa24.com	Name	Lucas E 340x320+VK 44	SKU	G0157	
	Drawing/Zeichnung	Foundation plan_Lagerholzplan		Format	A4
	Profile/Profil	4.4x13.5	Scale/Maßstab	1:50	Date

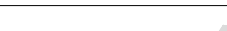







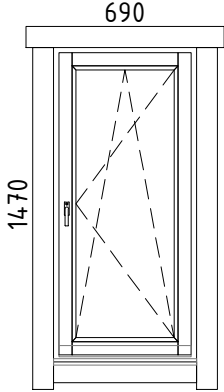

 www.hansa24.com	Name Lucas E 340x320+VK 44		SKU G0157
	Drawing/Zeichnung Roof Boards_Dachbretter		Format A4
	Profile/Profil 4.4x13.5	Scale/Maßstab 1:50	Date 18.05.2023

Pos	Model Lucas E 340x320+VK 44	Pcs	Profile (mm)	Length (mm)
	Notice! The gable pieces can be partly pre-assembled! Please notice - those differ from the description given in the specification list.			
	Achtung! Die Giebelbohlen können teilweise schon vormontiert sein! Bitte beachten - diese erscheinen nicht ganz so wie in der Teilleiste beschrieben.			
003	 spare log/Ersatzteile	1	44x135	3400
001		2	44x135	3600
002		1	44x135	3600
003		17	44x135	3400
004		1	44x68	3400
005		1	44x135	3400
006		1	44x135	3400
007		1	44x135	3200
008		17	44x135	3200
009		1	44x135	3200
010		1	44x127	3178
011		1	44x135	3178
012		2	44x135	3154
013		1	44x135	3078
014		1	44x127	3022
015		1	44x135	3022
016		1	44x135	2922
017		1	44x135	2866
018		1	44x135	2866
019		2	44x68	1678
020		1	44x68	1678
021		21	44x135	641
022		1	44x135	641
Kood	Lucas E 340x320+VK 44	Materjal	File	Leht 1/6

Pos	Model Lucas E 340x320+VK 44	Pcs	Profile (mm)	Length (mm)
023		9	44x135	498
024		2	44x135	498
025	146100 	2	44x68	290
026	146100 	28	44x135	290
AT1	FOUNDATION BEAMS (impregnated) - FUNDAMENTHÖLZER (imprägniert) 	3	70x45	3180
AT2	FOUNDATION BEAMS (impregnated) - FUNDAMENTHÖLZER (imprägniert) 	4	70x45	3040
AT3	FOUNDATION BEAMS (impregnated) - FUNDAMENTHÖLZER (imprägniert) 	2	70x45	2840
PR2	 PURLINS - PFETTEN	2	70x145	3713
PR3	 PURLINS - PFETTEN	1	70x145	3557
PR4	 PURLINS - PFETTEN	1	70x145	2843
PR1	 PURLINS - PFETTEN	2	70x145	2687
	ROOF BOARDS - DACHBRETTER 	55+1	113x18	3503
	FLOOR BOARDS - FUSSBODENBRETTER 	28+1	113x18	2907
	Ceiling mouldings - Deckenleisten (inside and outside - innen und außen) 		15x28	34 rm/lfm
	Floor mouldings - Fussbodenleisten 		18x40	13 rm/lfm
RLI01-1	Eave slat - Traufenleiste 18x40 		18x40	12.8 rm/lfm
KAR1-1	Parapet - Blende 336 	4	18x336	3118
KAR1-2	Parapet - Blende 336 	2	18x336	3603
KAR2-1	Parapet cover - U-Profil für Blenden 		44x65	20.21 rm/lfm
KAR3-1	Parapet support - Blendestütze 44x65 	8	44x65	200
KAR4-1	Parapet- connecting slat - Blende- Verbindungsleiste 	2	18x120	330
TP90-1	Support post - Stützpfofte 90x90 v1 	2	90x90	2064
ÜV1	Metal bar - Metallstange Ø10 	1	Ø10	1040
ÜV2	Metal bar - Metallstange Ø10 	1	Ø10	900
ÜV3	Metal bar - Metallstange Ø10 	1	Ø10	490
Kood	Lucas E 340x320+VK 44	Materjal	File	Leht 2/6

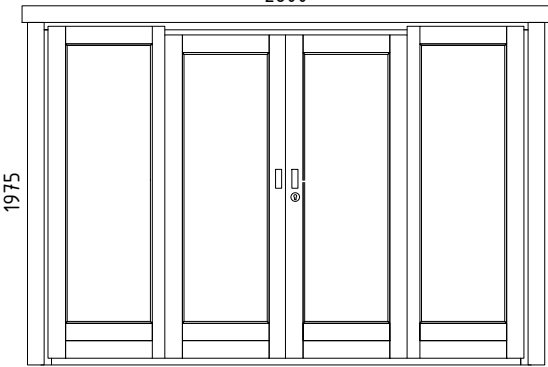
Pos	Model Lucas E 340x320+VK 44	Pcs	Profile (mm)	Length (mm)
ÜV4	Metal bar - Metallstange Ø10 	4	Ø10	360
ÜV5	Metal bar - Metallstange Ø10 	1	Ø10	350
PJ01	Adjustable post support - Verstellbare Pfostenstütze M16 	2		
ML01	Connecting strip for wall logs - Verbindungsstreifen für Wandbalken 	3		
LK	Hit block - Schlaghölzer 	3		
N-0 2503	Nails - Nägel 2.5x60 for floor boards - für Fussbodenbretter 	336		
N-0 2501	Nails - Nägel vierkant 2.5x50 for ceiling boards - für Dachbretter 	550		
KR-0 3001	Screws - Schrauben 3.0x30 for ceiling mouldings - für Deckenleisten 	52		
KR-0 3002	Screws - Schrauben 3.0x30 for eave slats - für Traufenleisten 	28		
KR-0 3003	Screws - Schrauben 3.0x30 for floor mouldings - für Fussbodenleisten 	26		
KR-0 3004	Screws - Schrauben 3.0x30 for parapet connecting slat - für Verbindungsleiste des Blendes 	16		
KR-0 3522	Screws - Schrauben 3.5x45 C3 for connecting strip for wall logs - für Verbindungsstreifen für Wandbalken 	12		
KR-0 3529	Screws - Schrauben 3.5x45 C3 for U-profile - für U-Profil 	44		
KR-0 5080	Screws - Schrauben 5.0x100 for foundation beams - für Fundamenthölzer 	36		
KR-0 5081	Screws - Schrauben 5.0x100 for parapet supports - für Blendestützen 	16		
KR-0 5031	Screws - Schrauben 5.0x70 C3 for parapet fastening - für Blendenbefestigung 	48		
KR-0 5033	Screws - Schrauben 5.0x70 C3 for post supports - für Pfostenstützen 	16		
KR-0 5034	Screws - Schrauben 5.0x70 C3 for support posts - für Stützpfosten 	4		
KL1	Threaded rod - Gewindestange M8 	4		2000
KL2	Threaded rod - Gewindestange M8 	2		460
KL3	Threaded rod - Gewindestange M8 	2		427
KL4	Threaded rod - Gewindestange M8 	2		393
KL5	Threaded rod - Gewindestange M8 	1		368
KL6	Threaded rod - Gewindestange M8 	2		300
KL03-1	Threaded rod for purlins - Gewindestange für die Pfetten M12 	6		150
Kood	Lucas E 340x320+VK 44	Materjal	File	Leht 3/6

Pos	Model Lucas E 340x320+VK 44	Pcs	Profile (mm)	Length (mm)	
	WINDOW 690x1470 W5-S44P-0XT-06901470  W119-PT Right handed - DIN rechts Tempered glass - Gehärtetes Glas Opens inside - Öffnet innen	2			
VIHM 01-1	Rain deflector - Regenabweiser		2	36x134	890
KR-0 3524	Screws - Schrauben 3.5x45 C3 for door and window trims - für Tür- und Fensterleisten		48		
KR-0 4001	Screws - Schrauben 4.0x60 C3 for rain deflector - für Regenabweiser		6		
Kood	Lucas E 340x320+VK 44	Materjal	File	Leht	5/6

Pos	Model Lucas E 340x320+VK 44	Pcs	Profile (mm)	Length (mm)	
	DOOR 2800x1975 D5-U44R-0XT-28001975  <p style="text-align: center;">2800</p> <p style="transform: rotate(-90deg); position: absolute; left: 168px; top: 180px;">1975</p> <p><u>D440-RT</u> Right handed - DIN rechts Tempered glass - Gehärtetes Glas Opens outside - Öffnet aussen</p>	1			
VIHM 01-2	Rain deflector - Regenabweiser		1	36x134	3000
KR-0 3524	Screws - Schrauben 3.5x45 C3 for door and window trims - für Tür- und Fensterleisten		38		
KR-0 4001	Screws - Schrauben 4.0x60 C3 for rain deflector - für Regenabweiser		7		
Kood	Lucas E 340x320+VK 44	Materjal	File	Leht	6/6

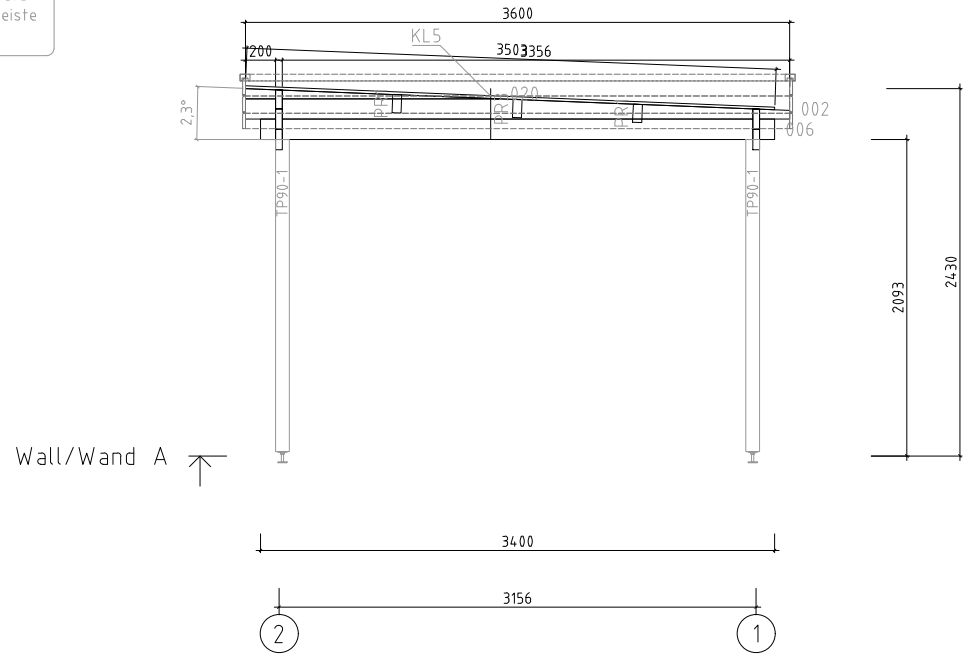
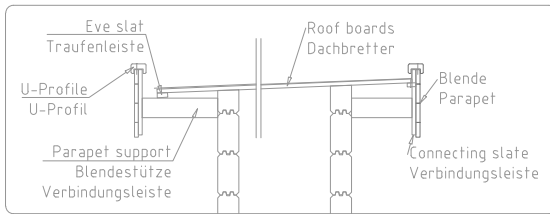

Name	Lucas E 340x320+VK 44	SKU	G0157
Drawing/Zeichnung	Wall/Wand A	Format	A4
Profile/Profil	4.4x13.5	Scale/Maßstab	1:50
		Date	18.05.2023

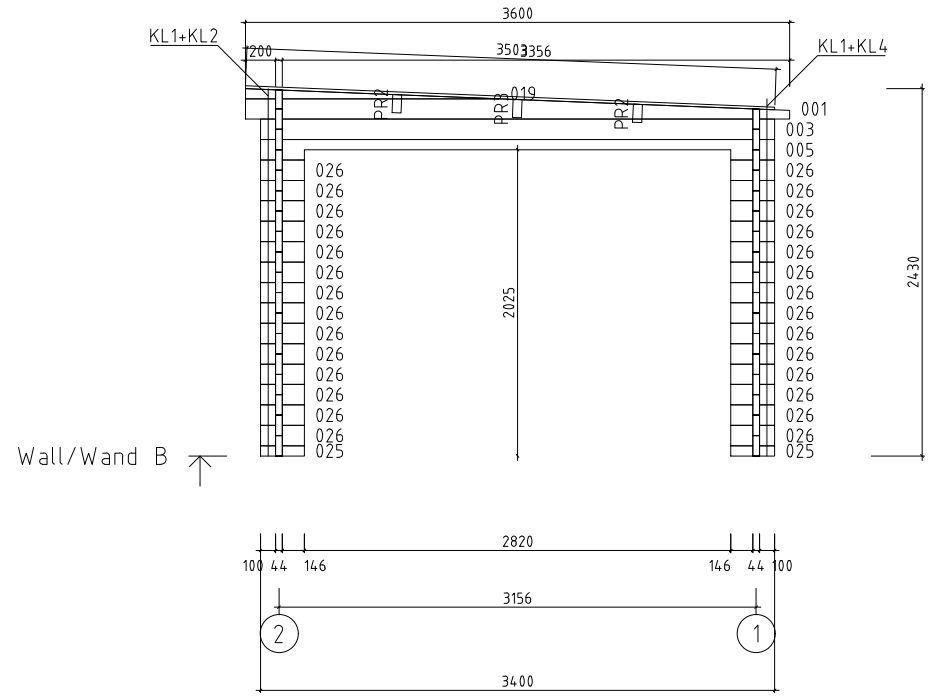

 www.hansa24.com	Name Lucas E 340x320+VK 44		SKU G0157
	Drawing/Zeichnung Wall/Wand B		Format A4
	Profile/Profil 4.4x13.5	Scale/Maßstab 1:50	Date 18.05.2023

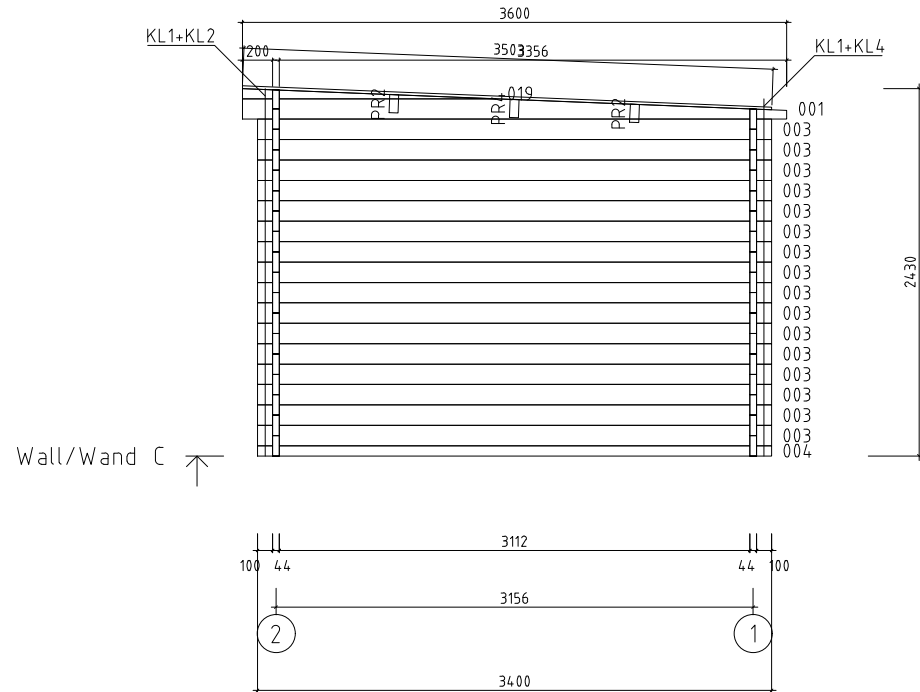

 www.hansa24.com	Name Lucas E 340x320+VK 44		SKU G0157
	Drawing/Zeichnung Wall/Wand C		Format A4
	Profile/Profil 4.4x13.5	Scale/Maßstab 1:50	Date 18.05.2023

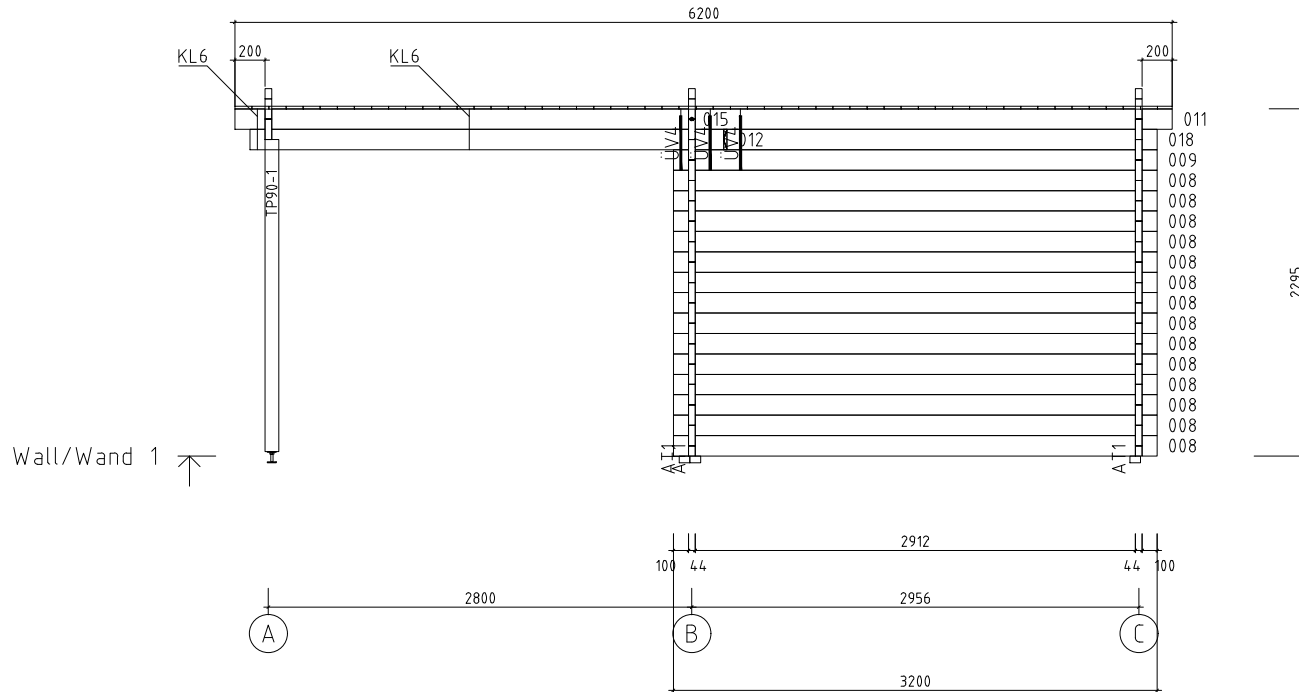

Wall/Wand 1 ↗

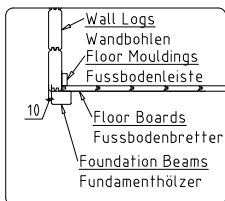

Name	Lucas E 340x320+VK 44	SKU	G0157
Drawing/Zeichnung	Wall/Wand 1	Format	A4
Profile/Profil	4.4x13.5	Scale/Maßstab	1:50
		Date	18.05.2023

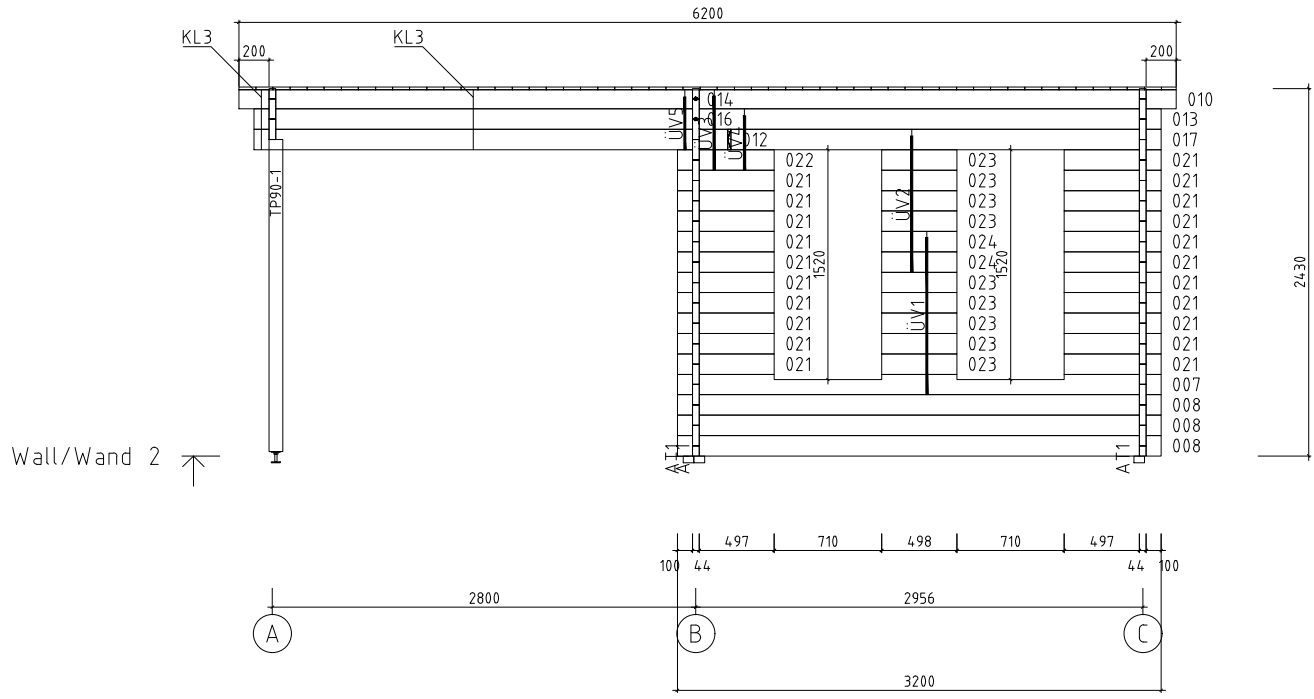

 www.hansa24.com	Name Lucas E 340x320+VK 44		SKU G0157
	Drawing/Zeichnung Wall/Wand 2		Format A4
	Profile/Profil 4.4x13.5	Scale/Maßstab 1:50	Date 18.05.2023