

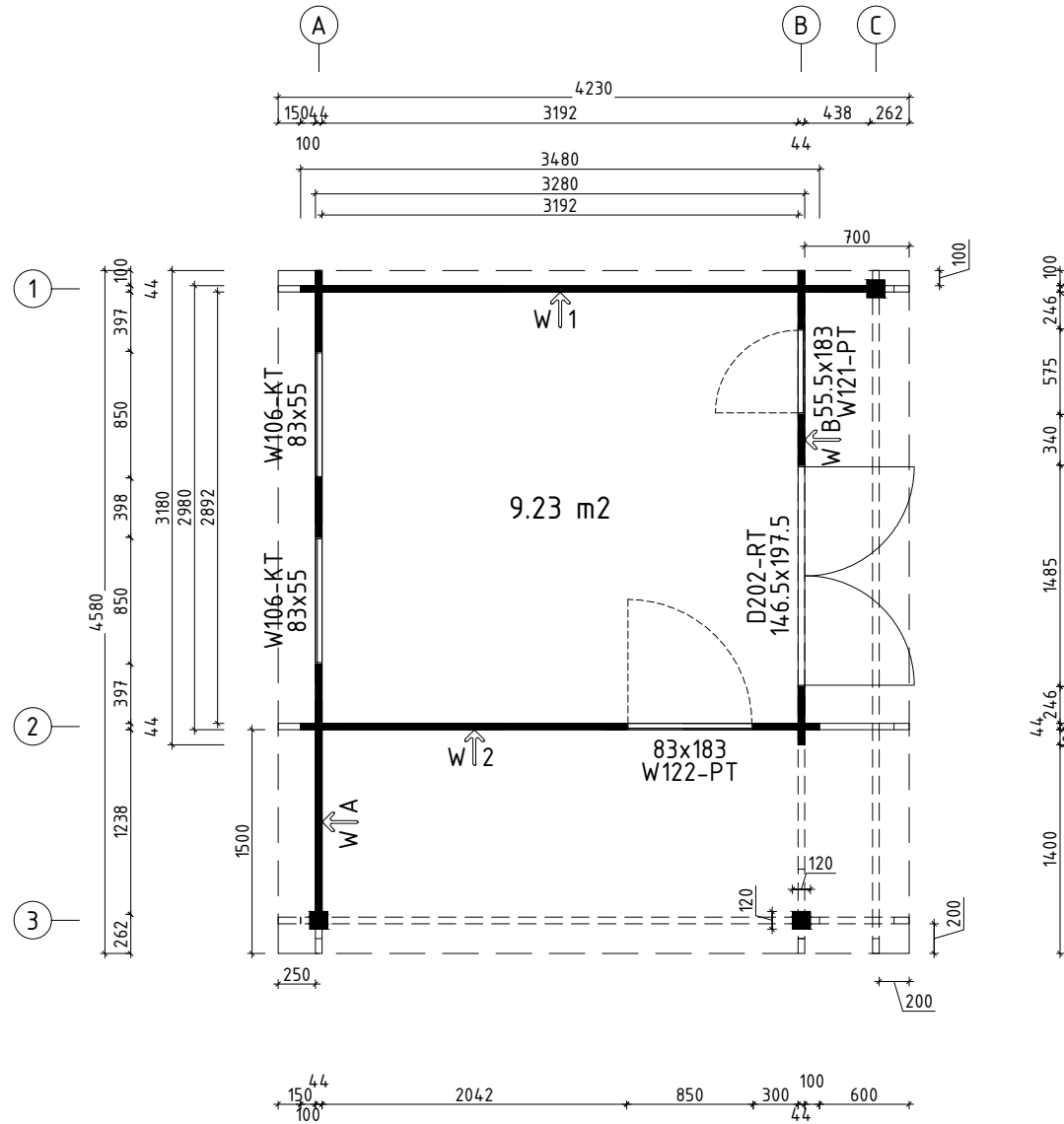

 www.hansa24.com	Name	Mini Hansa Lounge 348x318+VD+Terr 44	SKU	G0174
	Drawing/Zeichnung	3D		Format
	Profile/Profil	4.4x13.5	Scale/Maßstab	Date

H = 1.790 m
TOTAL: 15.13 m²





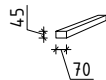
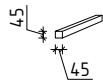
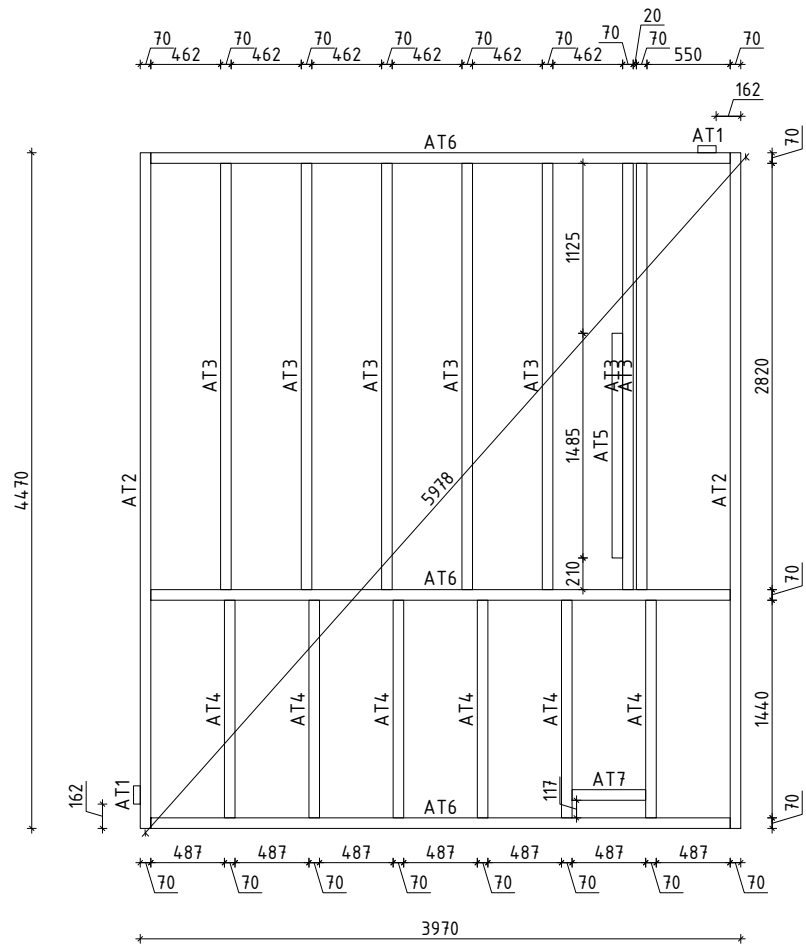





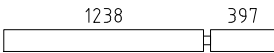
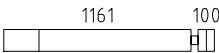







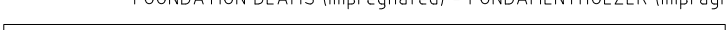
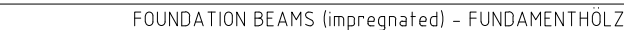

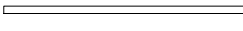



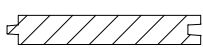
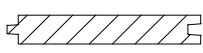
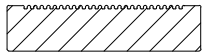







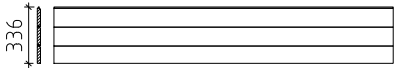
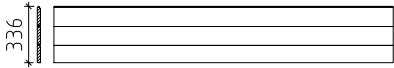
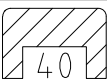
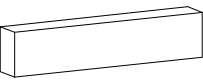
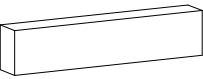
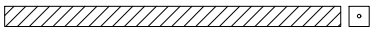
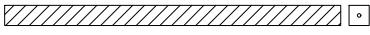
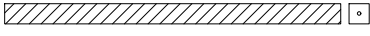

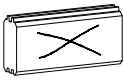

 www.hansa24.com	Name	Mini Hansa Lounge 348x318+VD+Terr 44	SKU	G0174	
	Drawing/Zeichnung	Plan_Grundplan	Format	A4	
	Profile/Profil	4.4x13.5	Scale/Maßstab	1:50	Date



 www.hansa24.com	Name Mini Hansa Lounge 348x318+VD+Terr 44		SKU G0174
	Drawing/Zeichnung Foundation plan_Lagerholzplan		Format A4
	Profile/Profil 4.4x13.5	Scale/Maßstab 1:50	Date 26.04.2023

Pos	Model Mini Hansa Lounge 348x318+VD+Terr 44	Pcs	Profile (mm)	Length (mm)
	Notice! The gable pieces can be partly pre-assembled! Please notice - those differ from the description given in the specification list.			
	Achtung! Die Giebelbohlen können teilweise schon vormontiert sein! Bitte beachten - diese erscheinen nicht ganz so wie in der Teilliste beschrieben.			
014	100 3192 spare log/Ersatzteile 438 	1	44x135	3818
001	200 1256 2892 100 	1	44x111	4580
002	200 1256 2892 100 	1	44x128	4580
003	200 1256 2892 100 	1	44x135	4580
004	100 1256 2892 100 	1	44x135	4480
005	100 1256 2892 100 	1	44x135	4480
006	1238 2892 100 	1	44x135	4318
007	1238 2892 100 	10	44x135	4318
008	250 3192 456 200 	1	44x135	4230
009	250 3192 456 200 	1	44x135	4230
010	250 3192 456 200 	1	44x135	4230
011	100 3192 456 100 	1	44x135	3980
012	100 3192 456 100 	1	44x135	3980
013	100 3192 456 100 	1	44x135	3980
014	100 3192 438 	14	44x135	3818
015	100 3192 438 	1	44x68	3818
016	100 3192 100 	1	44x135	3480
017	100 3192 100 	1	44x135	3480
018	100 3192 100 	1	44x68	3480
019	100 2042 	6	44x135	2186
020	100 2042 	2	44x135	2186
021	100 2042 	5	44x135	2186
022	1224 456 200 	1	44x68	1968
023	1224 456 200 	1	44x68	1968
024	1224 456 200 	1	44x68	1968
025	100 1256 397 	1	44x135	1841
Kood	Mini Hansa Lounge 348x318+VD+Terr 44	Materjal	File	G0174 Mini Hansa Lounge 348x318+VD+

Pos	Model Mini Hansa Lounge 348x318+VD+Terr 44	Pcs	Profile (mm)	Length (mm)
026		3	44x135	1679
027		1	44x135	1305
028		4	44x135	541
029		1	44x135	466
030		13	44x135	444
031		4	44x135	398
032		29	44x135	390
033		12	44x135	340
034		2	44x135	340
AT2	FOUNDATION BEAMS (impregnated) - FUNDAMENTHÖLZER (imprägniert) 	2	70x45	4470
AT6	FOUNDATION BEAMS (impregnated) - FUNDAMENTHÖLZER (imprägniert) 	3	70x45	3830
AT3	FOUNDATION BEAMS (impregnated) - FUNDAMENTHÖLZER (imprägniert) 	7	70x45	2820
AT5	FOUNDATION BEAMS (impregnated) - FUNDAMENTHÖLZER (imprägniert) 	1	70x45	1485
AT4	FOUNDATION BEAMS (impregnated) - FUNDAMENTHÖLZER (imprägniert) 	6	70x45	1440
AT7	FOUNDATION BEAMS (impregnated) - FUNDAMENTHÖLZER (imprägniert) 	1	70x45	487
AT1	FOUNDATION BEAMS (impregnated) - FUNDAMENTHÖLZER (imprägniert) 	2	45x45	120
PR1	PURLINS - PFEITEN 	3	70x145	4580
	ROOF BOARDS - DACHBRETTER 	41+1	113x18	4132
	FLOOR BOARDS - FUSSBODENBRETTER 	26+1	113x18	3187
	TERRACE BOARDS - BRETT 	3+1	120x28	3970
	TERRACE BOARDS - BRETT 	9	120x28	3934
	TERRACE BOARDS - BRETT 	24	120x28	698
	Ceiling mouldings - Deckenleisten (inside and outside - innen und außen) 		15x28	33 rm/lfm
	Floor mouldings - Fussbodenleisten 		18x40	13 rm/lfm
Kood	Mini Hansa Lounge 348x318+VD+Terr 44	Materjal	File	G0174 Mini Hansa Lounge 348x318+VD+Terr 44

Pos	Model Mini Hansa Lounge 348x318+VD+Terr 44	Pcs	Profile (mm)	Length (mm)
RLI01-1	Eave slat - Traufenleiste 18x40 		18x40	9.56 m/lfm
KAR1-1	Parapet - Blende 336 	2	18x336	4232
KAR1-2	Parapet - Blende 336 	2	18x336	4616
KAR2-1	Parapet cover - U-Profil für Blenden 		44x65	18.22 m/lfm
KAR3-1	Parapet support - Blendestütze 44x65 	3	44x65	200
KAR3-2	Parapet support - Blendestütze 44x65 	3	44x65	250
TP120-1	Support post - Stützpfooste 120x120 v3 	1	120x120	1785
TP120-2	Support post - Stützpfooste 120x120 v2 	1	120x120	1786
TP120-3	Support post - Stützpfooste 120x120 v2.1 	1	120x120	1921
ÜV1	Metal bar - Metallstange Ø10 	3	Ø10	1170
ÜV2	Metal bar - Metallstange Ø10 	1	Ø10	1040
ÜV3	Metal bar - Metallstange Ø10 	1	Ø10	770
PJ02	Adjustable post support - Verstellbare Pfostenstütze M20 	3		
LK	Hit block - Schlaghölzer 	3		
N-02503	Nails - Nägel 2.5x60 for floor boards - für Fussbodenbretter 	364		
N-02501	Nails - Nägel vierkant 2.5x50 for ceiling boards - für Dachbretter 	492		
KR-03001	Screws - Schrauben 3.0x30 for ceiling mouldings - für Deckenleisten 	56		
KR-03002	Screws - Schrauben 3.0x30 for eave slats - für Traufenleisten 	20		
KR-03003	Screws - Schrauben 3.0x30 for floor mouldings - für Fussbodenleisten 	28		
KR-03529	Screws - Schrauben 3.5x45 C3 for U-profile - für U-Profil 	36		
KR-04201	Screws - Schrauben 4.2x55 C3 for terrace boards - für Terrassenbretter 	576		
KR-05080	Screws - Schrauben 5.0x100 for foundation beams - für Fundamenthölzer 	76		
KR-05081	Screws - Schrauben 5.0x100 for parapet supports - für Blendestützen 	12		
Kood	Mini Hansa Lounge 348x318+VD+Terr 44	Materjal	File	G0174 Mini Hansa Lounge 348x318+VD+

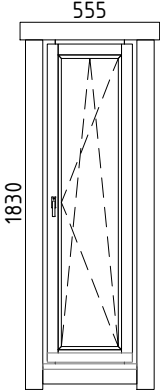
Pos	Model Mini Hansa Lounge 348x318+VD+Terr 44	Pcs	Profile (mm)	Length (mm)
	<p>WINDOW 555x1830 W5-S44P-0XT-05551830</p>  <p>555 1830</p> <p><u>W121-PT</u> Right handed - DIN rechts Tempered glass - Gehärtetes Glas Opens inside - Öffnet innen</p>	1		
KR-0 3524	Screws - Schrauben 3.5x45 C3 for door and window trims - für Tür- und Fensterleisten	24		
Kood	Mini Hansa Lounge 348x318+VD+Terr 44	Materjal	File	G0174 Mini Hansa Lounge 348x318+VD+

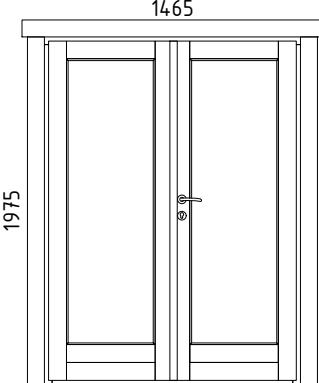
Pos	Model Mini Hansa Lounge 348x318+VD+Terr 44	Pcs	Profile (mm)	Length (mm)
	<p style="text-align: center;">DOOR 1465x1975 D5-D44R-0XT-14651975</p> <div style="display: flex; align-items: center; justify-content: center;">  <div style="margin-left: 20px;"> <p><u>D202-RT</u></p> <p>Right handed - DIN rechts Tempered glass - Gehärtetes Glas Opens outside - Öffnet aussen</p> </div> </div>	1		
KR-0 3524	Screws - Schrauben 3.5x45 C3 for door and window trims - für Tür- und Fensterleisten	28		
Kood	Mini Hansa Lounge 348x318+VD+Terr 44	Materjal	File	G0174 Mini Hansa Lounge 348x318+VD+

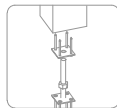
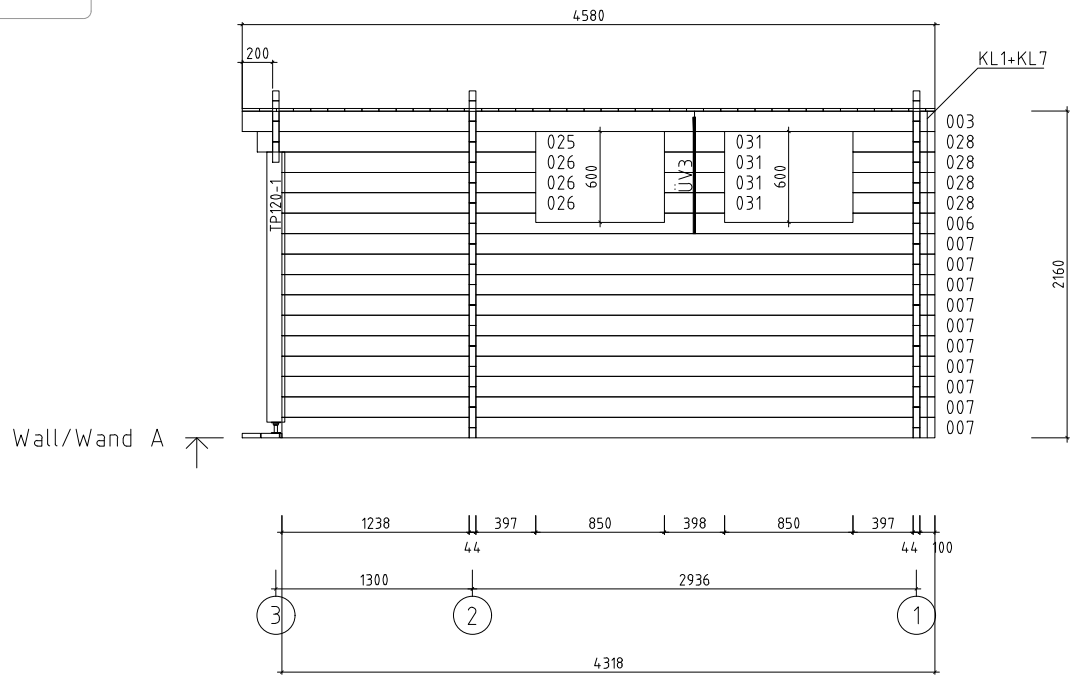
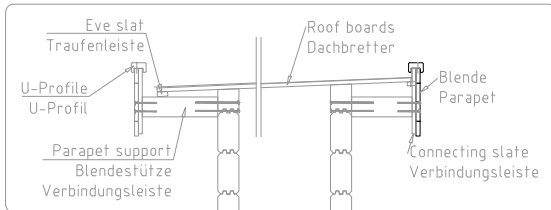

 www.hansa24.com	Name Mini Hansa Lounge 348x318+VD+Terr 44		SKU G0174
	Drawing/Zeichnung Wall/Wand A		Format A4
	Profile/Profil 4.4x13.5	Scale/Maßstab 1:50	Date 11.07.2023

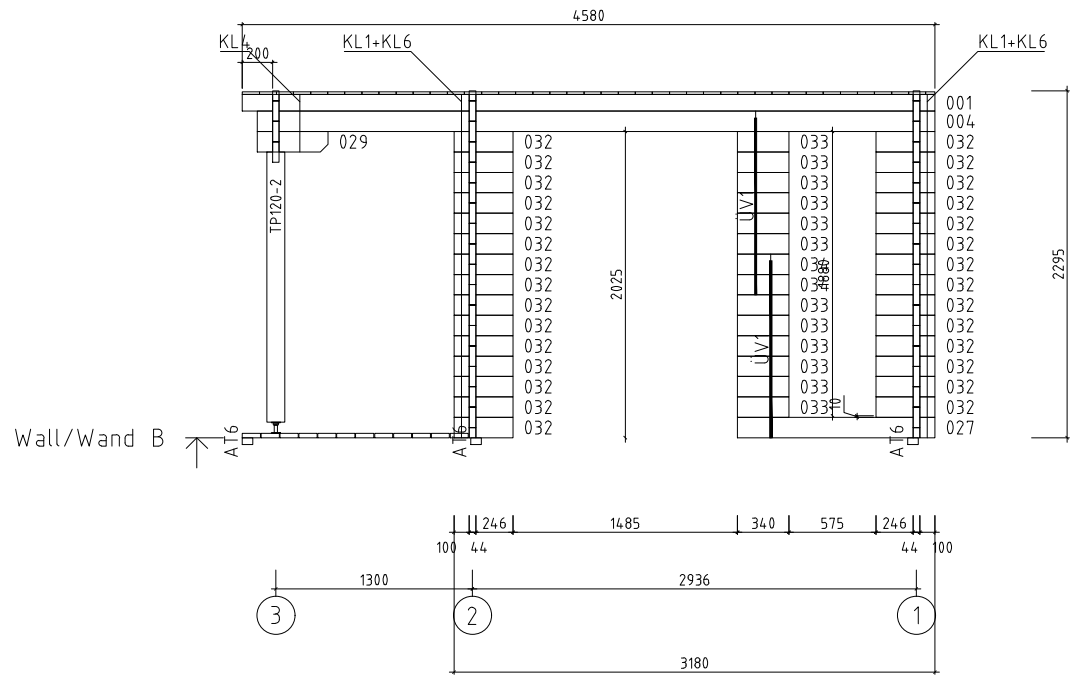

 www.hansa24.com	Name Mini Hansa Lounge 348x318+VD+Terr 44		SKU G0174
	Drawing/Zeichnung Wall/Wand B		Format A4
	Profile/Profil 4.4x13.5	Scale/Maßstab 1:50	Date 11.07.2023

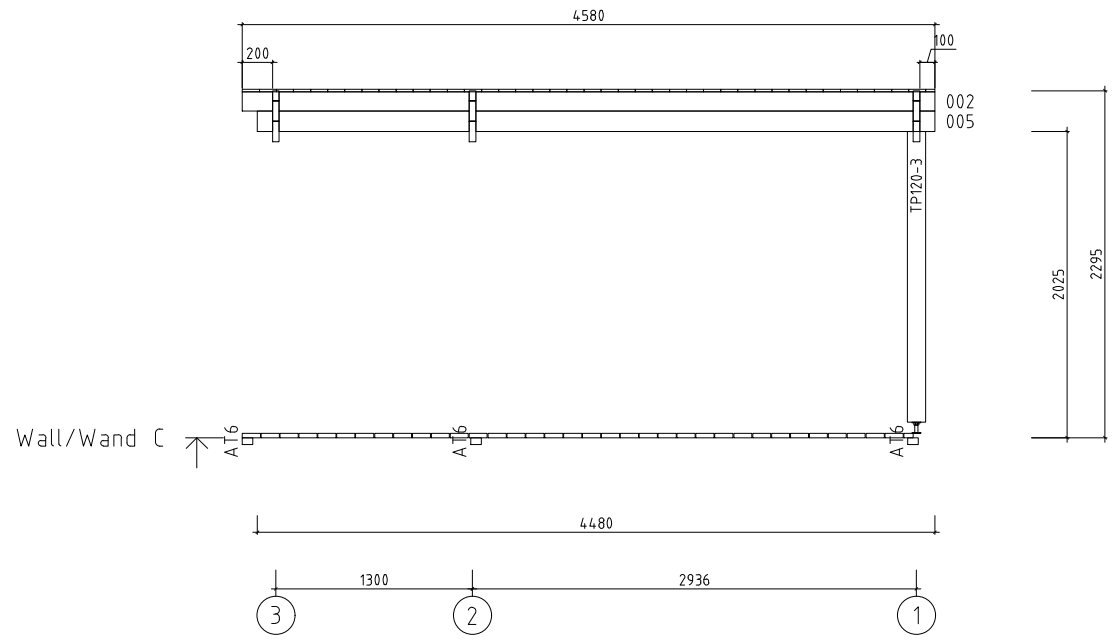

 www.hansa24.com	Name Mini Hansa Lounge 348x318+VD+Terr 44		SKU G0174
	Drawing/Zeichnung Wall/Wand C		Format A4
	Profile/Profil 4.4x13.5	Scale/Maßstab 1:50	Date 11.07.2023

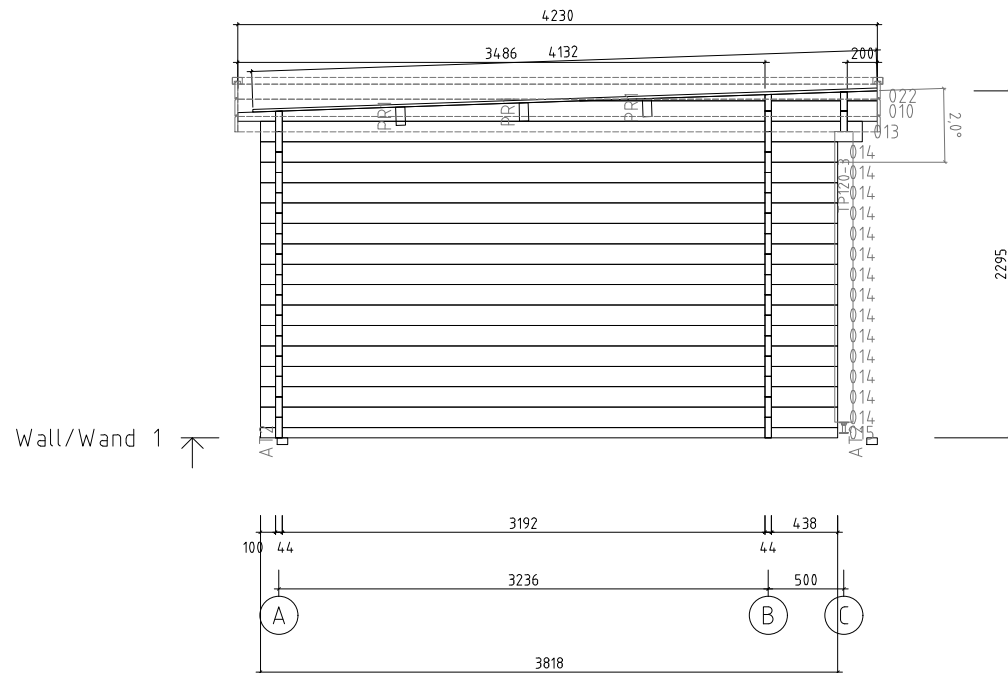

 www.hansa24.com	Name Mini Hansa Lounge 348x318+VD+Terr 44		SKU G0174
	Drawing/Zeichnung Wall/Wand 1		Format A4
	Profile/Profil 4.4x13.5	Scale/Maßstab 1:50	Date 11.07.2023

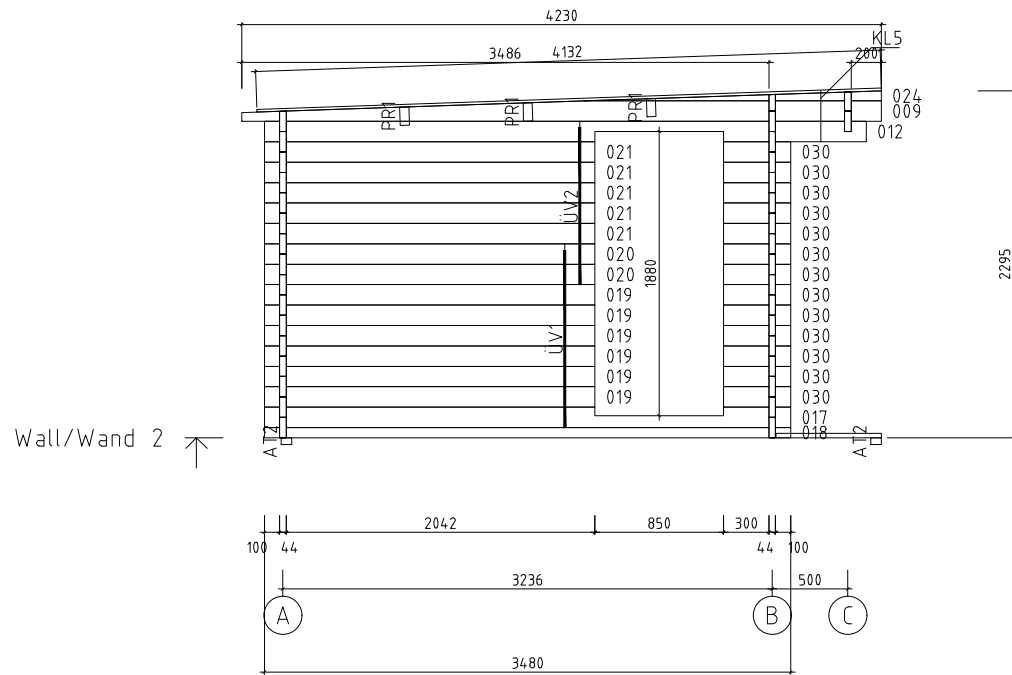

Wall/Wand 2 ↗

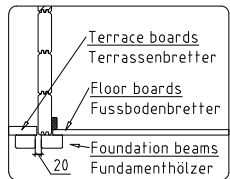

 www.hansa24.com	Name Mini Hansa Lounge 348x318+VD+Terr 44		SKU G0174
	Drawing/Zeichnung Wall/Wand 2		Format A4
	Profile/Profil 4.4x13.5	Scale/Maßstab 1:50	Date 11.07.2023

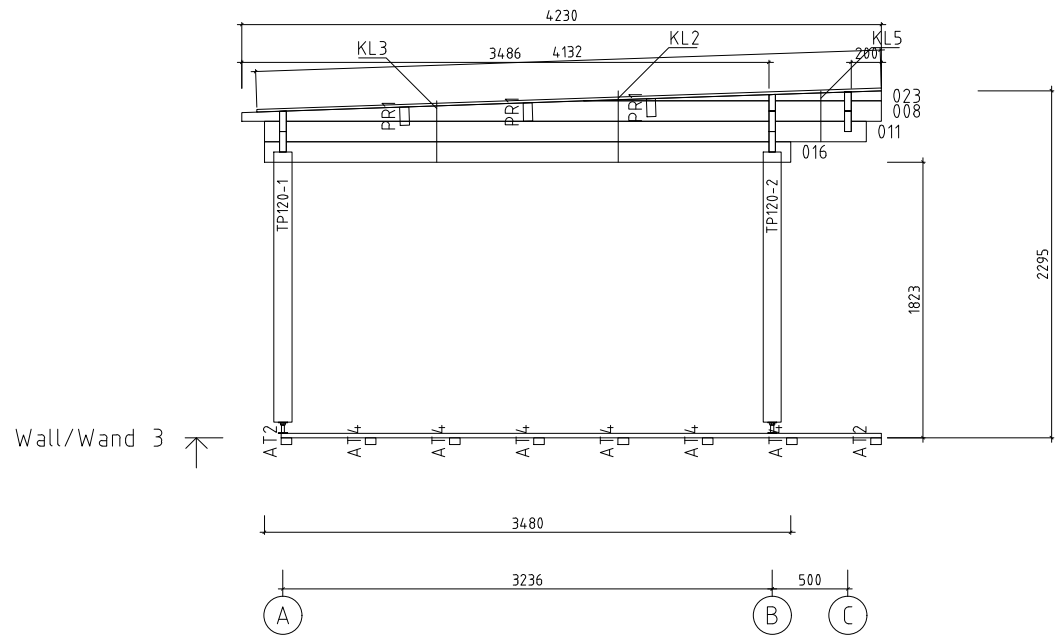

Wall/Wand 3 ↗



Name	Mini Hansa Lounge 348x318+VD+Terr 44	SKU	G0174
Drawing/Zeichnung	Wall/Wand 3	Format	A4
Profile/Profil	4.4x13.5	Scale/Maßstab	1:50
		Date	11.07.2023