

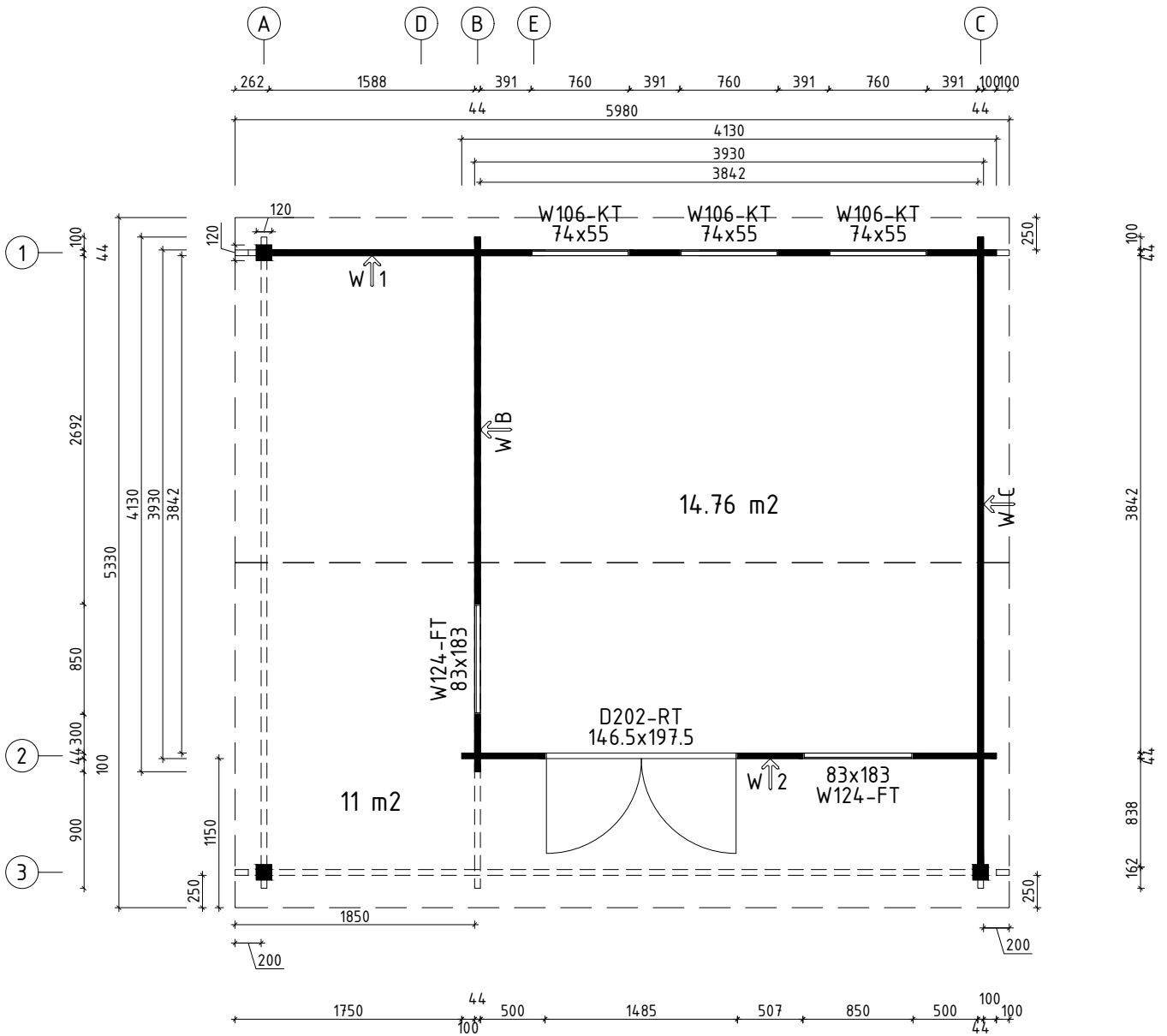



Name	Hansa Studio XL 413x413+VD+Terr 44	SKU	G0253
Drawing/Zeichnung	3D	Format	A4
Profile/Profil	4.4x13x5	Scale/Maßstab	Date
			07.03.2023





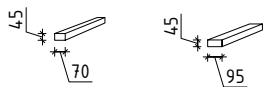
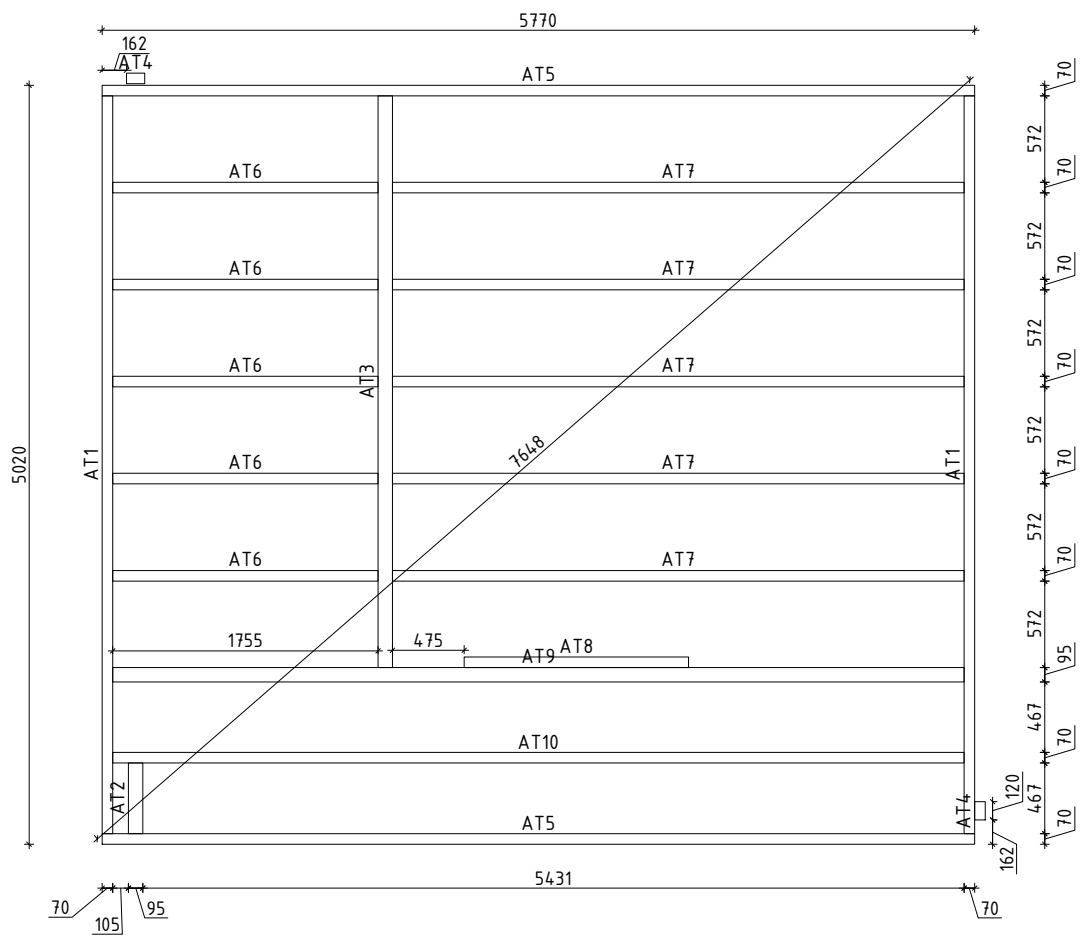



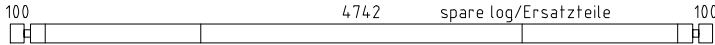

H = 1.790 m
TOTAL: 25.66 m²

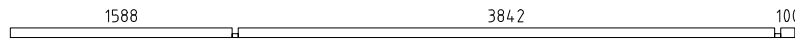

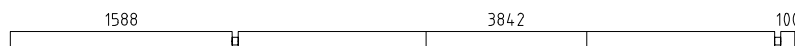
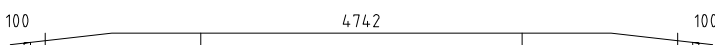
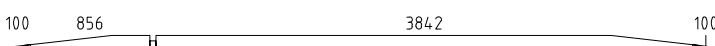

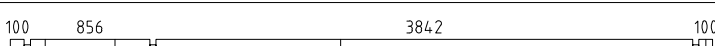
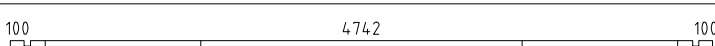
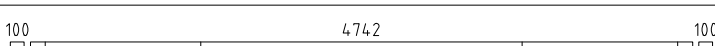

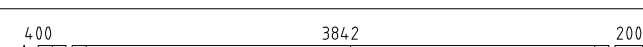
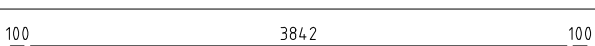
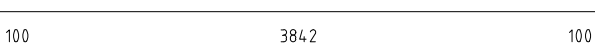
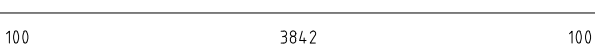
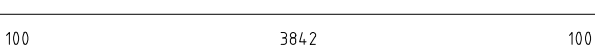
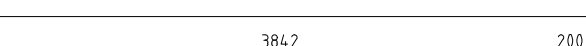
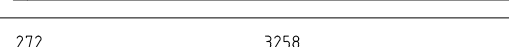

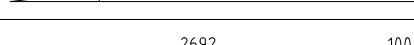
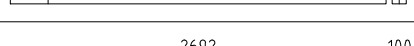
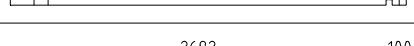
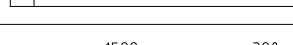

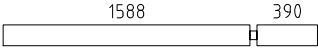
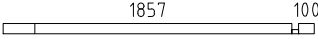
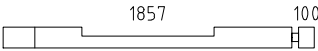
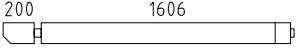
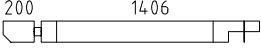
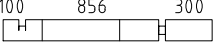
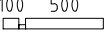
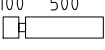















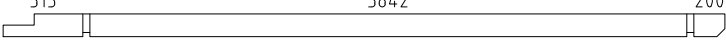

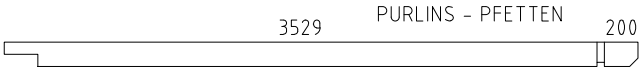
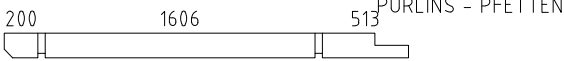
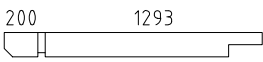
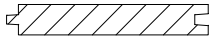

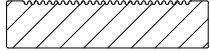
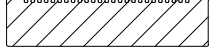

 www.hansa24.com	Name Hansa Studio XL 413x413+VD+Terr 44		SKU G0253
	Drawing/Zeichnung Plan_Grundplan		Format A4
	Profile/Profil 4.4x13x5	Scale/Maßstab 1:50	Date 07.03.2023

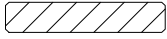

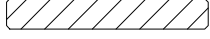

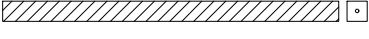
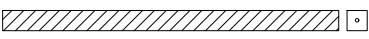
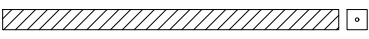
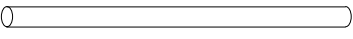

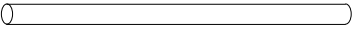
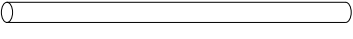





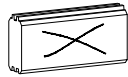











 www.hansa24.com	Name Hansa Studio XL 413x413+VD+Terr 44		SKU G0253
	Drawing/Zeichnung Foundation plan_Lagerholzplan		Format A4
	Profile/Profil 4.4x13x5	Scale/Maßstab 1:50	Date 07.03.2023

Pos	Model Hansa Studio XL 413x413+VD+Terr 44	Pcs	Profile (mm)	Length (mm)
	Notice! The gable pieces can be partly pre-assembled! Please notice - those differ from the description given in the specification list.			
	Achtung! Die Giebelbohlen können teilweise schon vormontiert sein! Bitte beachten - diese erscheinen nicht ganz so wie in der Teilliste beschrieben.			
011		1	44x135	5030
001		1	44x135	5780
002		1	44x135	5780
003		1	44x68	5618
004		9	44x135	5618
005		1	44x135	5618
006		1	44x135	5030
007		1	44x135	5030
008		1	44x135	5030
009		1	44x135	5030
010		1	44x135	5030
011		1	44x135	5030
012		1	44x135	5030
013		15	44x135	4868
014		1	44x135	4530
015		1	44x104	4130
016		1	44x135	4130
017		1	44x135	4130
018		1	44x135	4130
019		1	44x135	4108
020		2	44x135	3574
021		1	44x135	3574
022		6	44x135	2836
023		2	44x135	2836
024		6	44x135	2836
025		1	44x135	2023
Kood	Hansa Studio XL 413x413+VD+Terr 44	Materjal	File	Leht 1/8

Pos	Model Hansa Studio XL 413x413+VD+Terr 44	Pcs	Profile (mm)	Length (mm)
026		3	44x135	2023
027		1	44x68	2001
028		1	44x135	2001
029		1	44x135	1872
030		1	44x135	1650
031		1	44x135	1344
032		1	44x68	644
033		27	44x135	644
034		6	44x68	589
035		4	44x135	534
036		11	44x135	507
037		2	44x135	507
038		13	44x135	444
039		8	44x135	390
AT9	FOUNDATION BEAMS (impregnated) - FUNDAMENTHÖLZER (imprägniert) 	1	95x45	5630
AT3	FOUNDATION BEAMS (impregnated) - FUNDAMENTHÖLZER (imprägniert) 	1	95x45	3780
AT2	FOUNDATION BEAMS (impregnated) - FUNDAMENTHÖLZER (imprägniert) 	1	95x45	467
AT5	FOUNDATION BEAMS (impregnated) - FUNDAMENTHÖLZER (imprägniert) 	2	70x45	5770
AT10	FOUNDATION BEAMS (impregnated) - FUNDAMENTHÖLZER (imprägniert) 	1	70x45	5630
AT1	FOUNDATION BEAMS (impregnated) - FUNDAMENTHÖLZER (imprägniert) 	2	70x45	4880
AT7	FOUNDATION BEAMS (impregnated) - FUNDAMENTHÖLZER (imprägniert) 	5	70x45	3781
AT6	FOUNDATION BEAMS (impregnated) - FUNDAMENTHÖLZER (imprägniert) 	5	70x45	1754
AT8	FOUNDATION BEAMS (impregnated) - FUNDAMENTHÖLZER (imprägniert) 	1	70x45	1485
AT4	FOUNDATION BEAMS (impregnated) - FUNDAMENTHÖLZER (imprägniert) 	2	70x45	120
PR2	PURLINS - PFETTEN 	3	70x145	4643
Kood	Hansa Studio XL 413x413+VD+Terr 44	Materjal	File	Leht 2/8

Pos	Model Hansa Studio XL 413x413+VD+Terr 44	Pcs	Profile (mm)	Length (mm)
PR4	 <p>PURLINS - PFETTEN</p>	2	70x145	3773
PR3	 <p>PURLINS - PFETTEN</p>	2	70x145	2407
PR1	 <p>PURLINS - PFETTEN</p>	3	70x145	1537
	ROOF BOARDS - DACHBRETTER		106+2 113x18	2683
	FLOOR BOARDS - FUSSBODENBRETTER		34+1 113x18	3837
	TERRACE BOARDS - BRETTER		3+1 120x28	5020
	TERRACE BOARDS - BRETTER		12 120x28	4984
	TERRACE BOARDS - BRETTER		31 120x28	1098
	TERRACE BOARDS - BRETTER		1 120x28	262
	Ceiling mouldings - Deckenleisten (inside and outside - innen und außen)		15x28	54 rm/lfm
	Floor mouldings - Fussbodenleisten		18x40	17 rm/lfm
RLA 01-1	Eave board - Traufenbrett 18x95		2 18x95	5980
RLI01-1	Eave slat - Traufenleiste 18x40		18x40	12.96 rm/lfm
VLA 02-1	Gable board - Giebelbrett 18x120	6.6° 	4 18x120	2783
VKL 01-1	Gable cover slat - Giebeldeckleiste 18x40		4 18x40	2783
TP1 20-1	Support post - Stützpfole 120x120 v2		1 120x120	1854
TP1 20-2	Support post - Stützpfole 120x120 v3		1 120x120	1854
TP1 20-3	Support post - Stützpfole 120x120 v3		1 120x120	1921
ÜV1	Metal bar - Metallstange Ø10		3 Ø10	1170
ÜV2	Metal bar - Metallstange Ø10		1 Ø10	1100
ÜV3	Metal bar - Metallstange Ø10		2 Ø10	770
ÜV4	Metal bar - Metallstange Ø10		2 Ø10	360
PJ02	Adjustable post support - Verstellbare Pfostenstütze M20		3	
Kood	Hansa Studio XL 413x413+VD+Terr 44	Materjal	File	Leht 3/8

Pos	Model Hansa Studio XL 413x413+VD+Terr 44		Pcs	Profile (mm)	Length (mm)
ML01	Connecting strip for wall logs - Verbindungsstreifen für Wandbalken		1		
GD01	Diamond - Diamant		2		
LK	Hit block - Schlaghölzer		3		
N-0 2503	Nails - Nägel 2.5x60 for floor boards - für Fussbodenbretter		476		
N-0 2501	Nails - Nägel vierkant 2.5x50 for ceiling boards - für Dachbretter		848		
N-0 2504	Nails - Nägel vierkant 2.5x50 for support tile - für Fliese		1		
KR-0 3001	Screws - Schrauben 3.0x30 for ceiling mouldings - für Deckenleisten		66		
KR-0 3002	Screws - Schrauben 3.0x30 for eave slats - für Traufenleisten		24		
KR-0 3003	Screws - Schrauben 3.0x30 for floor mouldings - für Fussbodenleisten		32		
KR-0 3522	Screws - Schrauben 3.5x45 C3 for connecting strip for wall logs - für Verbindungsstreifen für Wandbalken		4		
KR-0 3523	Screws - Schrauben 3.5x45 C3 for diamonds - für Diamanten		4		
KR-0 3525	Screws - Schrauben 3.5x45 C3 for eave boards - für Traufenbretter		24		
KR-0 3527	Screws - Schrauben 3.5x45 C3 for gable boards - für Giebelbretter		24		
KR-0 3521	Screws - Schrauben 3.5x45 C3 for gable cover slats - für Giebeldeckleisten		24		
KR-0 4201	Screws - Schrauben 4.2x55 C3 for terrace boards - für Terrassenbretter		846		
KR-0 5080	Screws - Schrauben 5.0x100 for foundation beams - für Fundamenthölzer		84		
KR-0 5033	Screws - Schrauben 5.0x70 C3 for post supports - für Pfostenstützen		24		
KR-0 5034	Screws - Schrauben 5.0x70 C3 for support posts - für Stützpfeiler		6		
TPL01	Support tile - Fliese		1		
KL1	Threaded rod - Gewindestange M8		2		2000
KL2	Threaded rod - Gewindestange M8		2		570
KL3	Threaded rod - Gewindestange M8		4		435
KL4	Threaded rod - Gewindestange M8		2		325
Kood	Hansa Studio XL 413x413+VD+Terr 44	Materjal	File	Leht	4/8

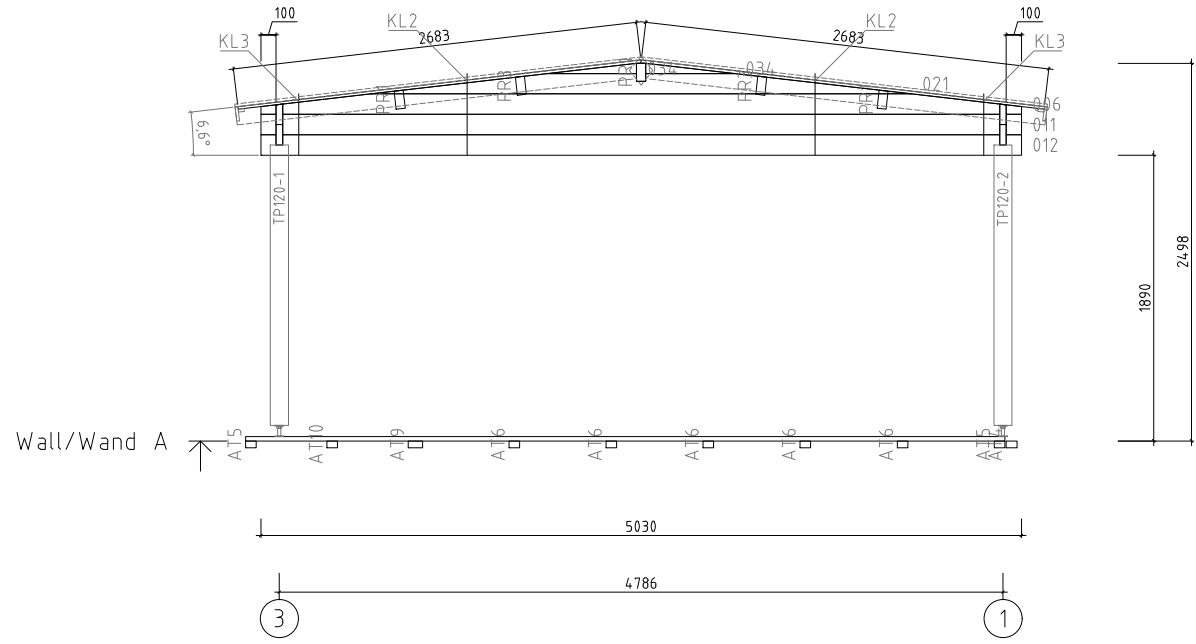
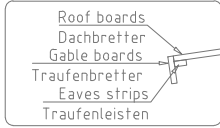

Name	Hansa Studio XL 413x413+VD+Terr 44		SKU	G0253	
Drawing/Zeichnung	Wall/Wand A		Format	A4	
Profile/Profil	4.4x13.5	Scale/Maßstab	1:50	Date	07.03.2023

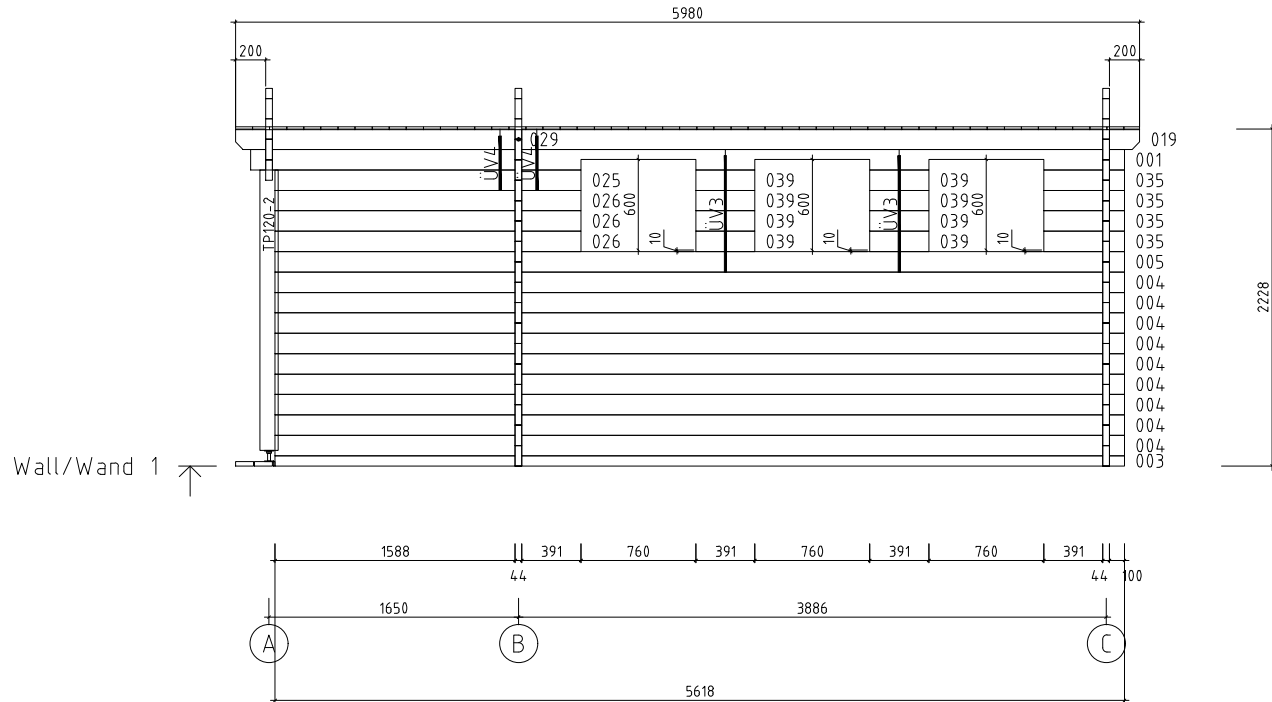
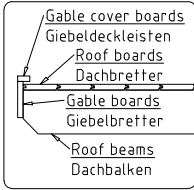

 www.hansa24.com	Name Hansa Studio XL 413x413+VD+Terr 44		SKU G0253
	Drawing/Zeichnung Wall/Wand 1		Format A4
	Profile/Profil 4.4x13.5	Scale/Maßstab 1:50	Date 07.03.2023

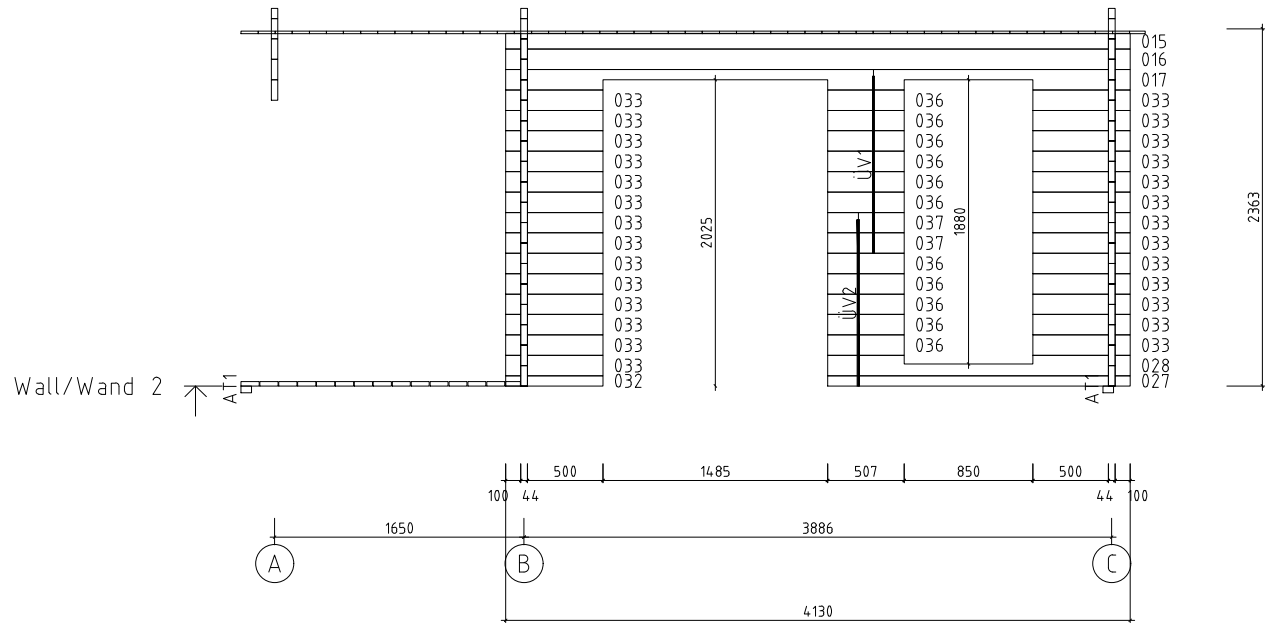

 www.hansa24.com	Name Hansa Studio XL 413x413+VD+Terr 44		SKU G0253
	Drawing/Zeichnung Wall/Wand 2		Format A4
	Profile/Profil 4.4x13.5	Scale/Maßstab 1:50	Date 07.03.2023

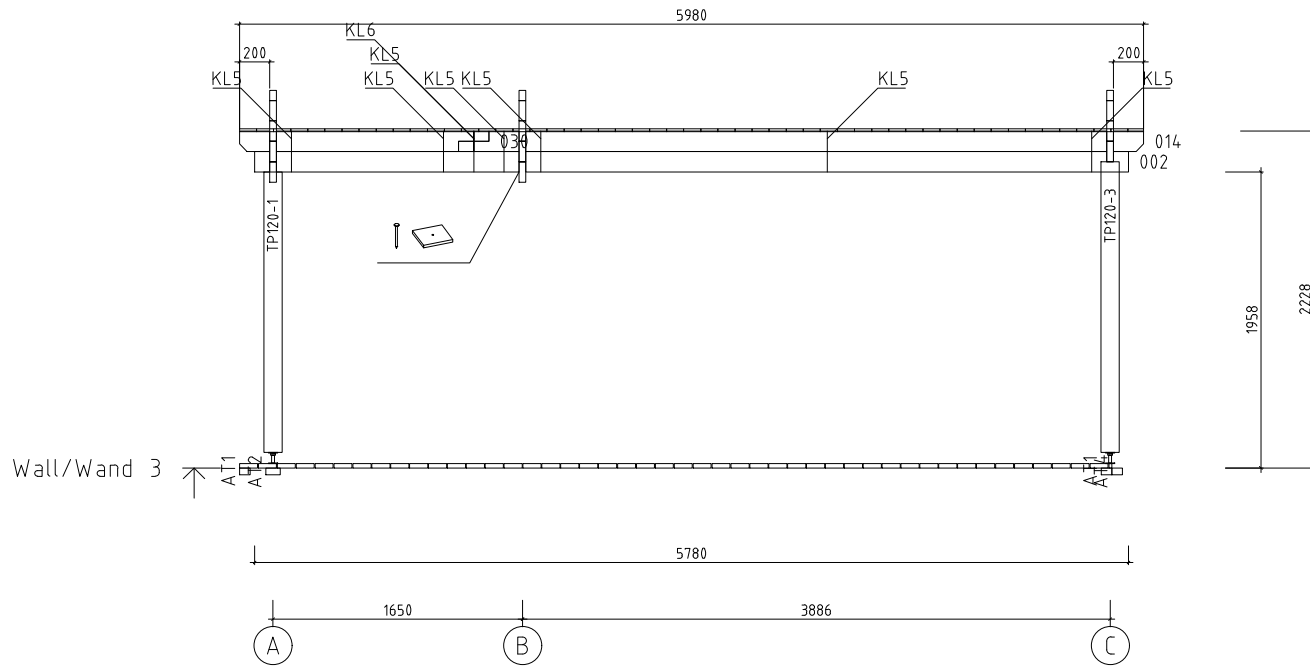

Name	Hansa Studio XL 413x413+VD+Terr 44	SKU	G0253
Drawing/Zeichnung	Wall/Wand 3	Format	A4
Profile/Profil	4.4x13.5	Scale/Maßstab	1:50
		Date	07.03.2023