

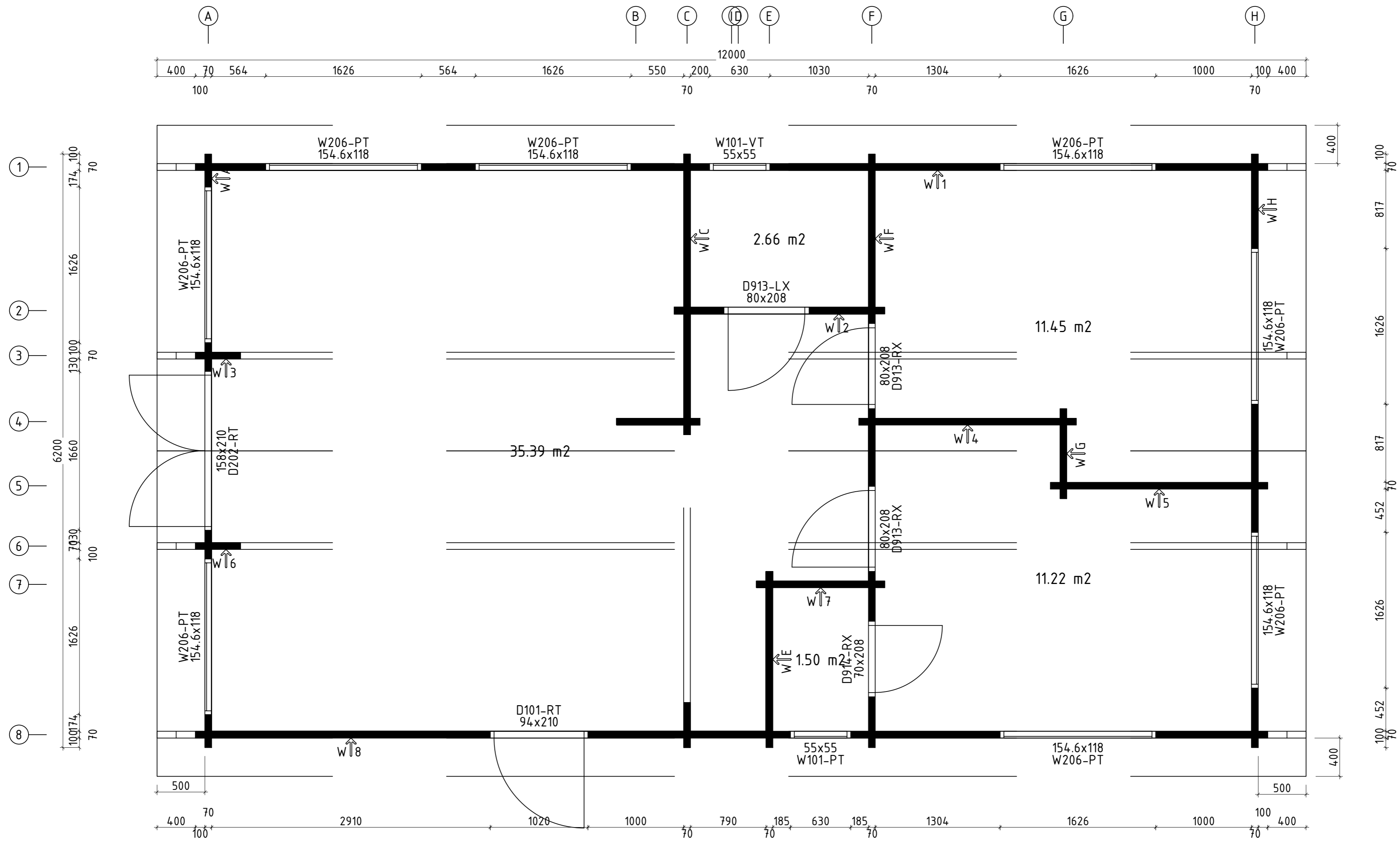

 www.hansa24.com	Name		Valencia 620x1120 70		SKU		G0262
	Drawing/Zeichnung		3D		Format		A3
	Profile/Profil	7x13.5	Scale/Maßstab	1:40	Date	22.09.2022	

H = 1.800 m
TOTAL: 62.22 m²



	Name Valencia 620x1120 70		SKU G0262
	Drawing/Zeichnung Plan_Grundplan		Format A3
	Profile/Profil 7x13.5	Scale/Maßstab 1:40	Date 21.09.2022

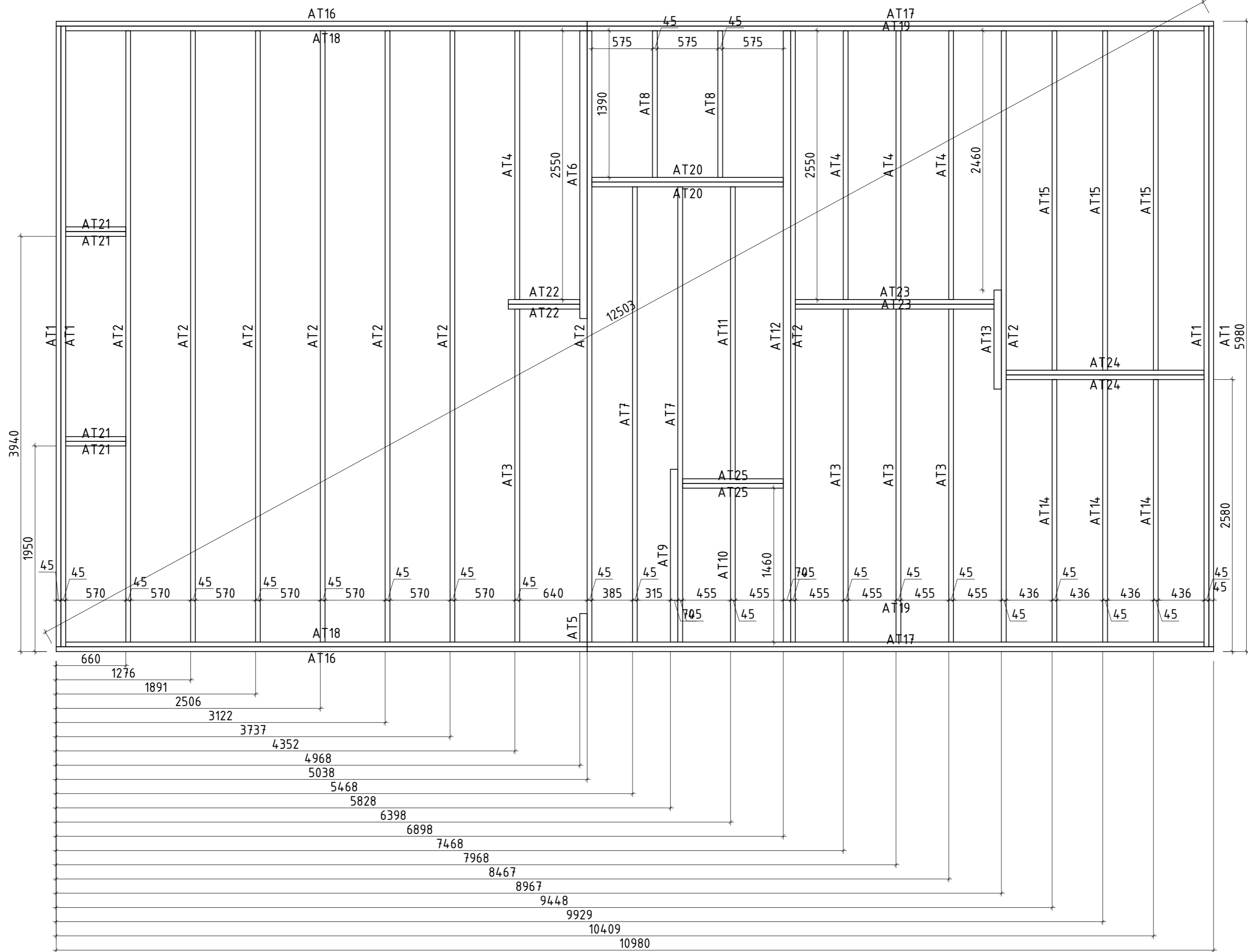



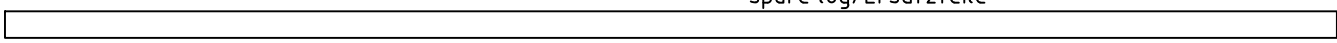
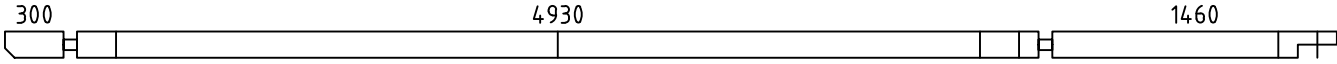
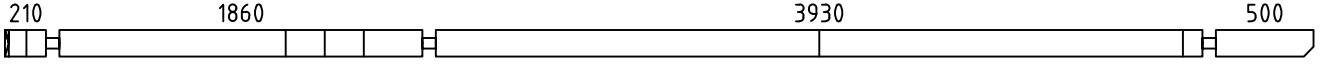
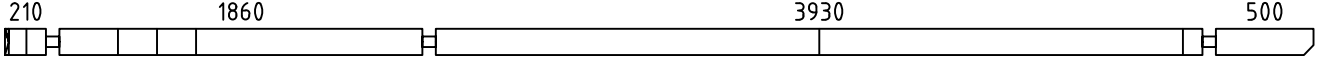
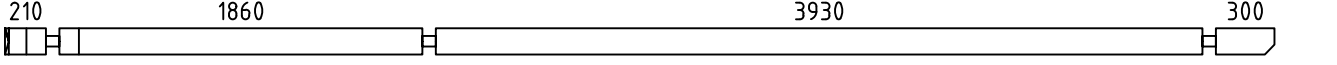
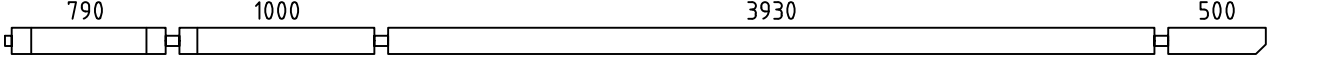
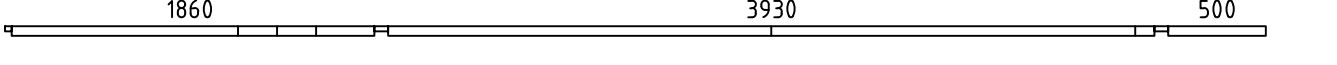
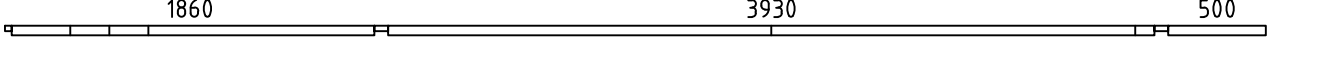
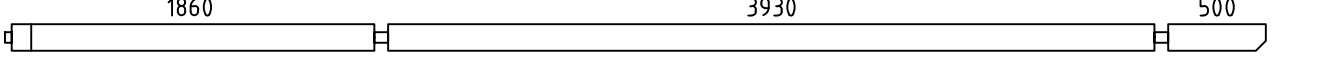
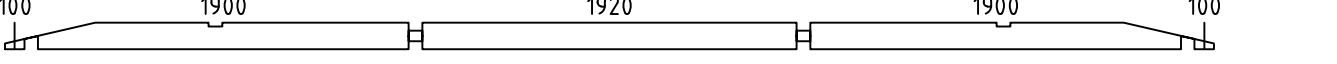
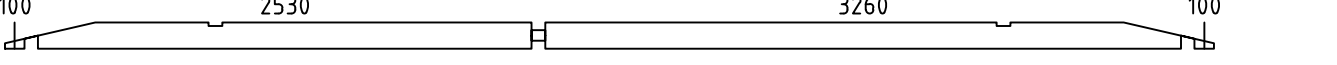
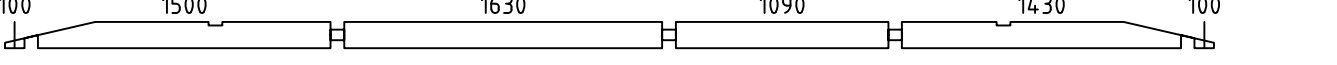
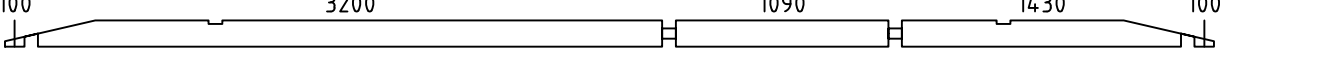
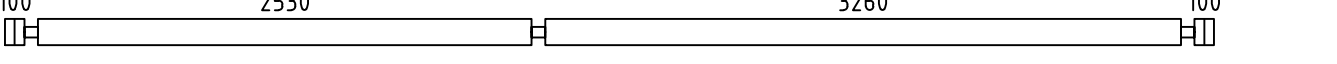
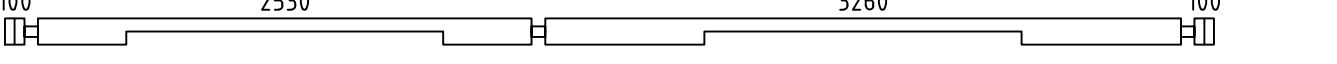
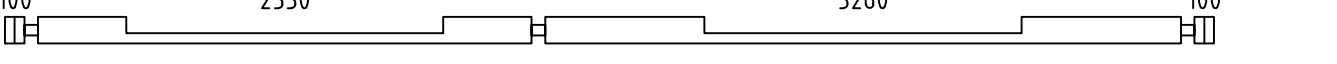
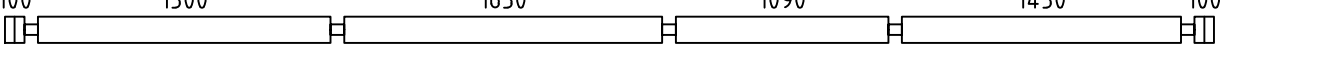
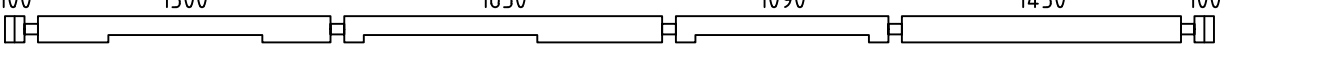
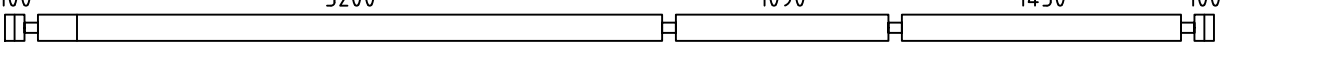
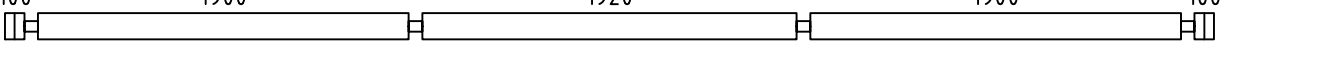
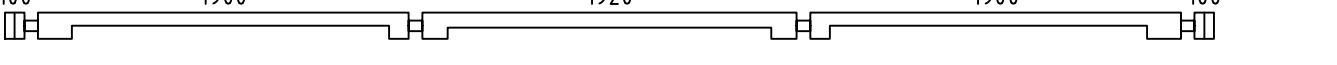
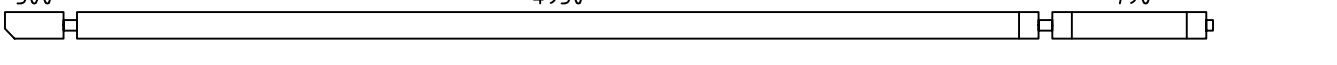
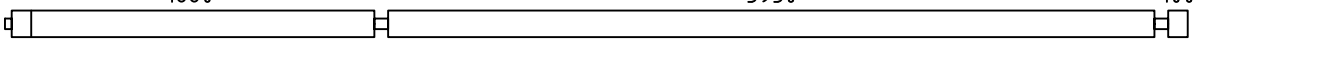



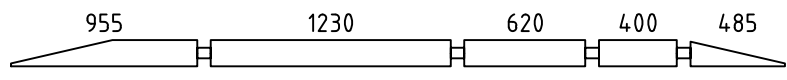
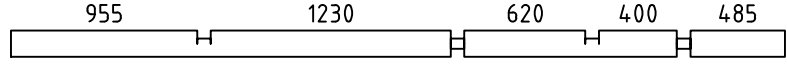
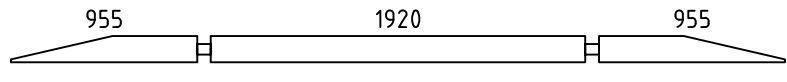
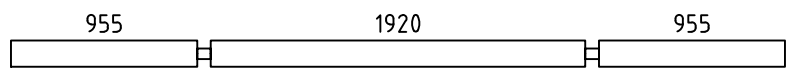
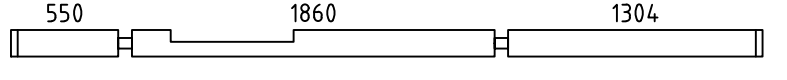
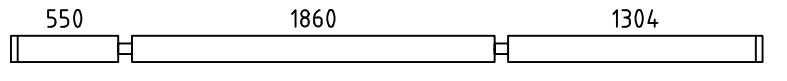
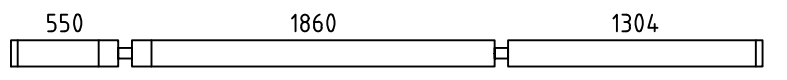
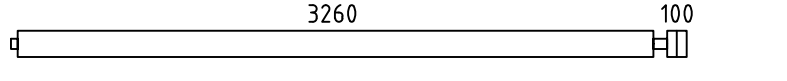
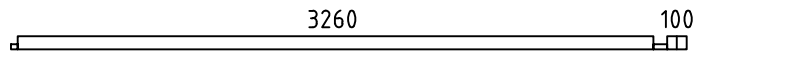
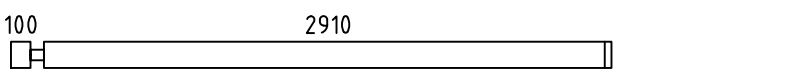
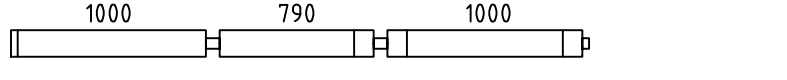
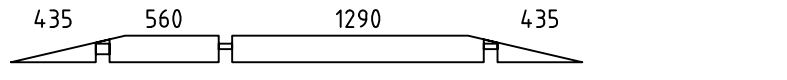
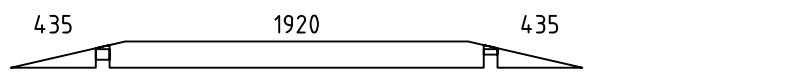
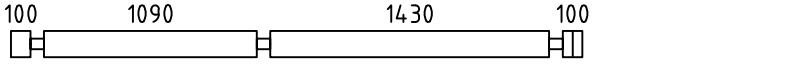
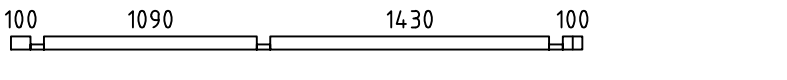
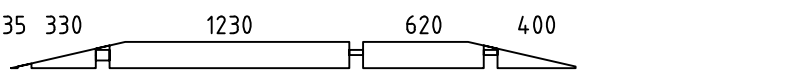
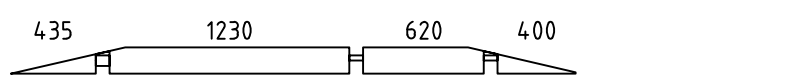
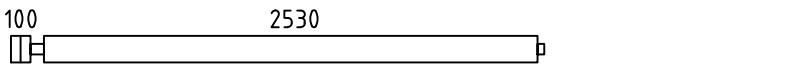
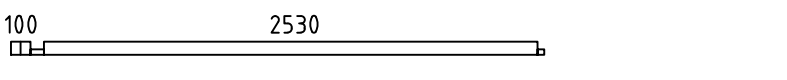
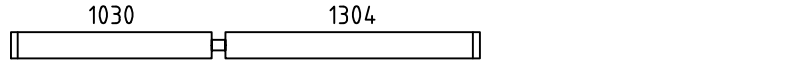
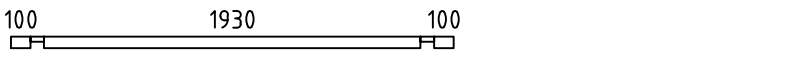
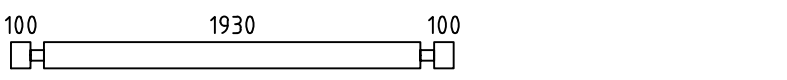
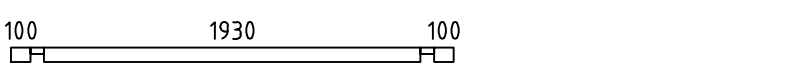
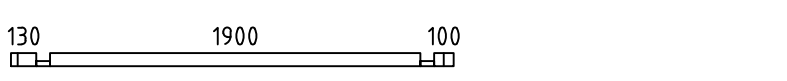
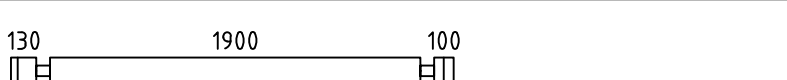

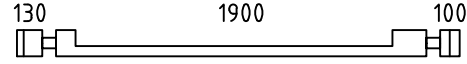
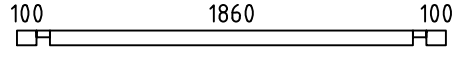
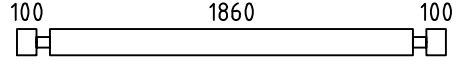
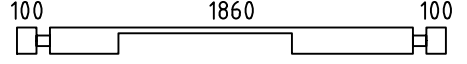

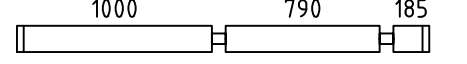
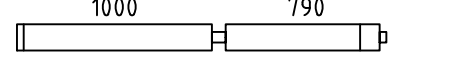
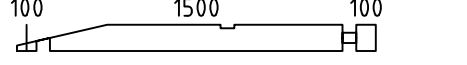
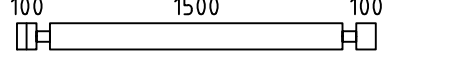
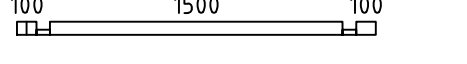
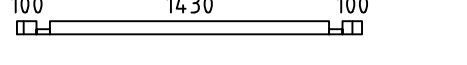
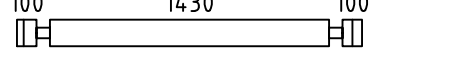
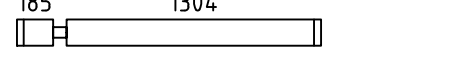
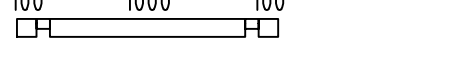
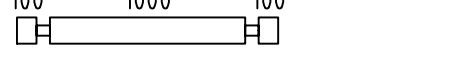
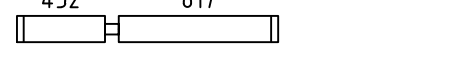
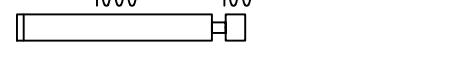
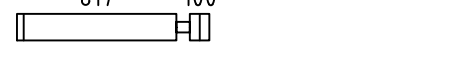
 www.hansa24.com	Name	Valencia 620x1120 70	SKU	G0262
	Drawing/Zeichnung	Foundation plan_Lagerholzplan	Format	A3
	Profile/Profil	Scale/Maßstab	1:40	Date

Pos	Model Valencia 620x1120 70	Pcs	Profile (mm)	Length (mm)
	Notice! The gable pieces can be partly pre-assembled! Please notice - those differ from the description given in the specification list.			
	Achtung! Die Giebelbohlen können teilweise schon vormontiert sein! Bitte beachten - diese erscheinen nicht ganz so wie in der Teileliste beschrieben.			
000	 spare log/Ersatzteile	1	70x135	6830
001		1	70x135	6830
002		1	70x135	6710
003		1	70x135	6710
004		1	70x135	6510
005		1	70x135	6465
006		1	70x49	6465
007		1	70x49	6465
008		1	70x135	6465
009		1	70x135	6200
010		1	70x135	6200
011		1	70x135	6200
012		1	70x135	6200
013		6	70x135	6200
014		1	70x135	6200
015		1	70x135	6200
016		1	70x135	6200
017		1	70x135	6200
018		1	70x135	6200
019		1	70x135	6200
020		1	70x135	6200
021		1	70x135	6195
022		5	70x135	6065
Kood	Valencia 620x1120 70	Materjal	File	G0262 Valencia 620x1120 70.dwg

Pos	Model Valencia 620x1120 70	Pcs	Profile (mm)	Length (mm)
023		1	70x135	6065
024		1	70x135	5970
025		1	70x135	5840
026		1	70x135	5830
027		1	70x135	5535
028		1	70x49	5535
029		1	70x49	5535
030		1	70x135	5535
031		1	70x135	5405
032		1	70x135	5380
033		2	70x135	5310
034		3	70x135	5205
035		5	70x135	5135
036		1	70x135	5135
037		1	70x135	5110
038		1	70x135	4970
039		1	70x135	4304
040		3	70x135	4304
041		1	70x135	4304
042		1	70x135	4135
043		3	70x135	4135
044		1	70x135	3970
045		1	70x135	3970
046		1	70x135	3970
047		1	70x135	3969
Kood	Valencia 620x1120 70	Materjal	File	G0262 Valencia 620x1120 70.dwg

Pos	Model Valencia 620x1120 70	Pcs	Profile (mm)	Length (mm)
048		1	70x135	3969
049		1	70x135	3969
050		1	70x135	3969
051		1	70x135	3969
052		1	70x135	3854
053		3	70x135	3854
054		1	70x135	3854
055		1	70x135	3465
056		1	70x68	3465
057		16	70x135	3080
058		4	70x135	2965
059		1	70x135	2930
060		1	70x135	2930
061		16	70x135	2930
062		1	70x68	2930
063		1	70x135	2895
064		1	70x135	2895
065		1	70x135	2735
066		1	70x68	2735
067		4	70x135	2404
068		1	70x59	2270
069		44	70x135	2270
070		1	70x73	2270
071		2	70x68	2270
072		12	70x135	2270

Pos	Model Valencia 620x1120 70	Pcs	Profile (mm)	Length (mm)
073		2	70x135	2270
074		1	70x76	2200
075		4	70x135	2200
076		1	70x135	2200
077		1	70x135	2115
078		3	70x135	2115
079		3	70x135	1895
080		1	70x135	1840
081		17	70x135	1840
082		1	70x68	1840
083		1	70x68	1770
084		15	70x135	1770
085		4	70x135	1559
086		1	70x92	1340
087		20	70x135	1340
088		8	70x135	1339
089		18	70x135	1170
090		8	70x135	987
091		21	70x135	940
092		1	70x68	940
093		1	70x73	870
094		13	70x135	870
095		4	70x135	870
096		5	70x135	870
097		5	70x135	844

Kood Valencia 620x1120 70

Materjal



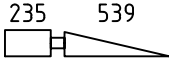
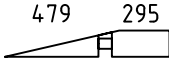
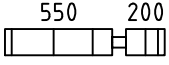
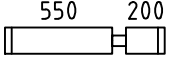
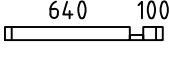
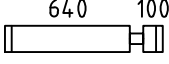
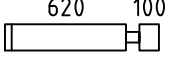
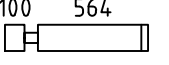
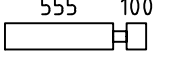
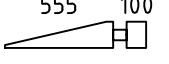
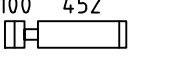
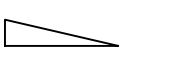
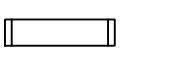
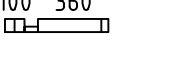
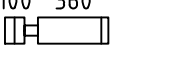
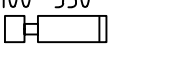
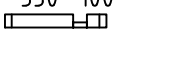
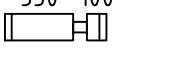
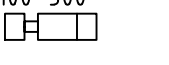
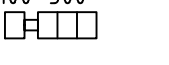
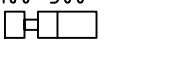
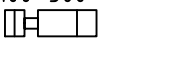
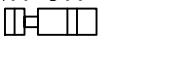
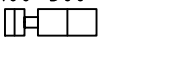
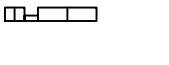











File G0262 Valencia 620x1120 70.dwg

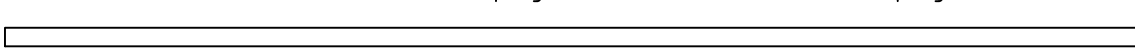
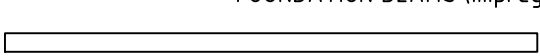
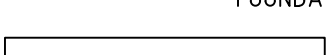
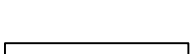

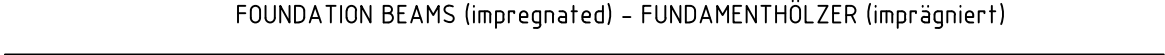
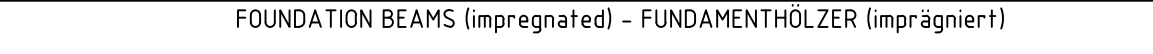

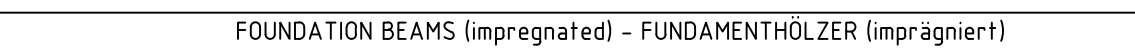
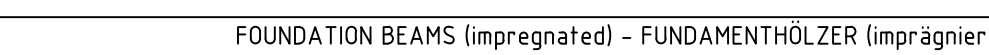
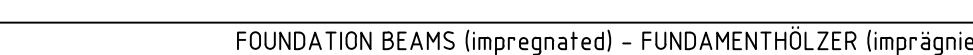

Pos	Model Valencia 620x1120 70	Pcs	Profile (mm)	Length (mm)
098		2	70x135	844
099		1	70x135	844
100		1	70x135	820
101		3	70x135	820
102		1	70x68	810
103		15	70x135	810
104		15	70x135	790
105		9	70x135	734
106		1	70x135	725
107		1	70x135	725
108		8	70x135	622
109		9	70x134	582
110		9	70x135	564
111		1	70x68	530
112		15	70x135	530
113		15	70x135	520
114		1	70x68	520
115		15	70x135	520
116		15	70x135	470
117		8	70x135	470
118		15	70x135	470
119		7	70x135	470
120		1	70x135	470
121		8	70x135	470
122		1	70x68	470

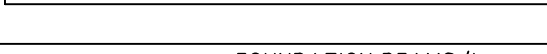
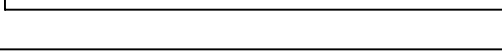
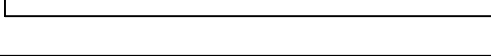
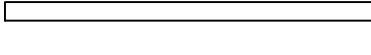

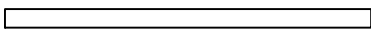
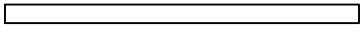
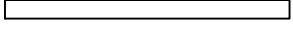
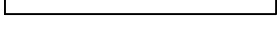
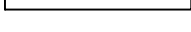
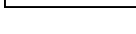
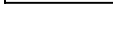
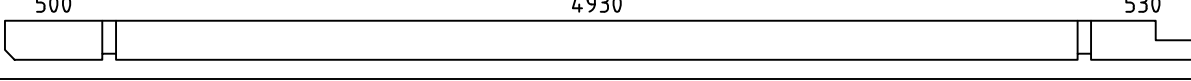
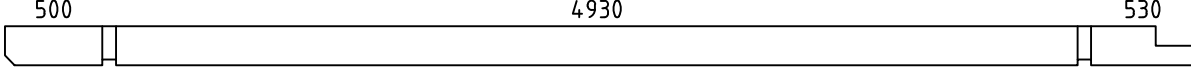
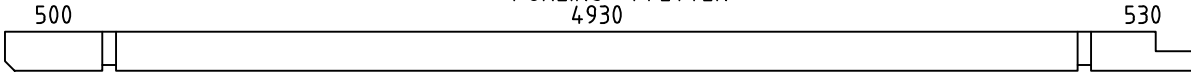
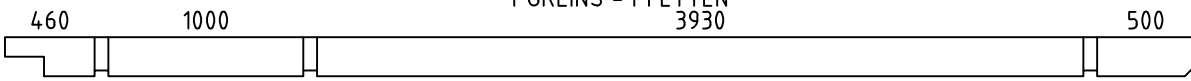
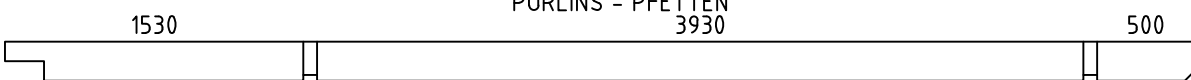
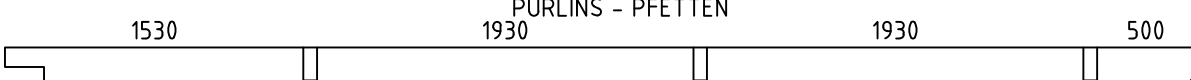
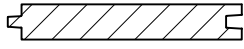

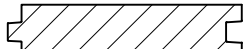
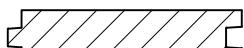
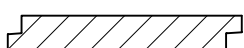
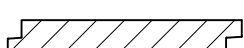
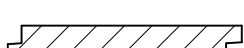
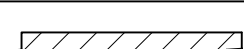
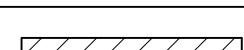





Kood Valencia 620x1120 70

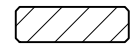
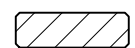
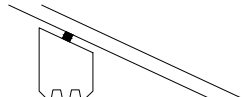
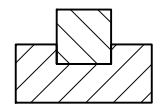
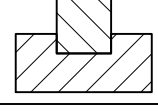
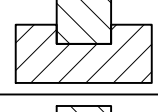
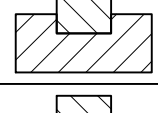
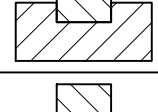
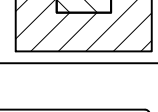
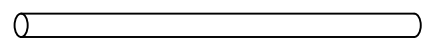
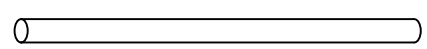
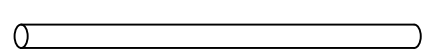
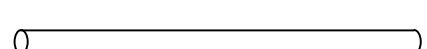
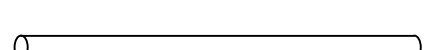









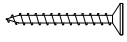
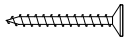





Materjal





File G0262 Valencia 620x1120 70.dwg 17



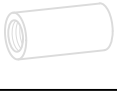

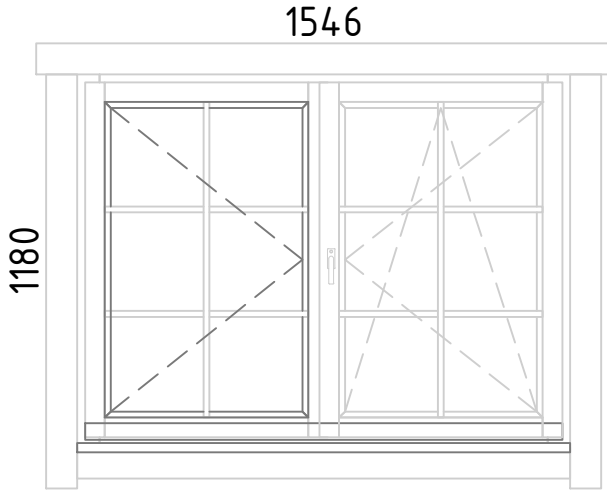
Pos	Model Valencia 620x1120 70	Pcs	Profile (mm)	Length (mm)
123	100 295 	1	70x135	465
124	235 100 	1	70x135	405
125	174 100 	16	70x135	344
126	130 100 	16	70x135	300
127		7	70x59	258
128		3	70x59	235
129	35100 	1	70x47	205
AT12	FOUNDATION BEAMS (impregnated) - FUNDAMENTHÖLZER (imprägniert) 	1	70x95	5800
AT6	FOUNDATION BEAMS (impregnated) - FUNDAMENTHÖLZER (imprägniert) 	1	70x95	2730
AT9	FOUNDATION BEAMS (impregnated) - FUNDAMENTHÖLZER (imprägniert) 	1	70x95	1640
AT13	FOUNDATION BEAMS (impregnated) - FUNDAMENTHÖLZER (imprägniert) 	1	70x95	940
AT5	FOUNDATION BEAMS (impregnated) - FUNDAMENTHÖLZER (imprägniert) 	1	70x95	270
AT17	FOUNDATION BEAMS (impregnated) - FUNDAMENTHÖLZER (imprägniert) 	2	45x95	5943
AT1	FOUNDATION BEAMS (impregnated) - FUNDAMENTHÖLZER (imprägniert) 	4	45x95	5890
AT19	FOUNDATION BEAMS (impregnated) - FUNDAMENTHÖLZER (imprägniert) 	2	45x95	5853
AT2	FOUNDATION BEAMS (impregnated) - FUNDAMENTHÖLZER (imprägniert) 	9	45x95	5800
AT16	FOUNDATION BEAMS (impregnated) - FUNDAMENTHÖLZER (imprägniert) 	2	45x95	5038
AT18	FOUNDATION BEAMS (impregnated) - FUNDAMENTHÖLZER (imprägniert) 	2	45x95	4948
AT7	FOUNDATION BEAMS (impregnated) - FUNDAMENTHÖLZER (imprägniert) 	2	45x95	4320
AT15	FOUNDATION BEAMS (impregnated) - FUNDAMENTHÖLZER (imprägniert) 	3	45x95	3220
AT3	FOUNDATION BEAMS (impregnated) - FUNDAMENTHÖLZER (imprägniert) 	4	45x95	3160
AT11	FOUNDATION BEAMS (impregnated) - FUNDAMENTHÖLZER (imprägniert) 	1	45x95	2770
AT4	FOUNDATION BEAMS (impregnated) - FUNDAMENTHÖLZER (imprägniert) 	4	45x95	2550
AT14	FOUNDATION BEAMS (impregnated) - FUNDAMENTHÖLZER (imprägniert) 	3	45x95	2490
AT23	FOUNDATION BEAMS (impregnated) - FUNDAMENTHÖLZER (imprägniert) 	2	45x95	1885
Kood	Valencia 620x1120 70	Materjal	File	G0262 Valencia 620x1120 70.dwg



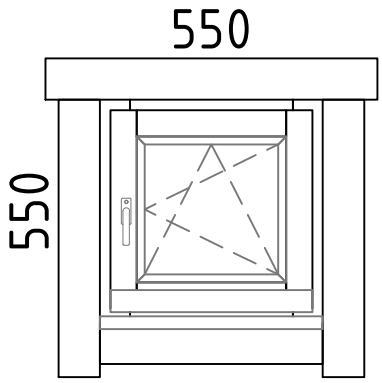

Pos	Model Valencia 620x1120 70	Pcs	Profile (mm)	Length (mm)
AT24	FOUNDATION BEAMS (impregnated) - FUNDAMENTHÖLZER (imprägniert) 	2	45x95	1878
AT20	FOUNDATION BEAMS (impregnated) - FUNDAMENTHÖLZER (imprägniert) 	2	45x95	1815
AT10	FOUNDATION BEAMS (impregnated) - FUNDAMENTHÖLZER (imprägniert) 	1	45x95	1460
AT8	FOUNDATION BEAMS (impregnated) - FUNDAMENTHÖLZER (imprägniert) 	2	45x95	1390
AT25	FOUNDATION BEAMS (impregnated) - FUNDAMENTHÖLZER (imprägniert) 	2	45x95	955
AT22	FOUNDATION BEAMS (impregnated) - FUNDAMENTHÖLZER (imprägniert) 	2	45x95	677
AT21	FOUNDATION BEAMS (impregnated) - FUNDAMENTHÖLZER (imprägniert) 	4	45x95	570
PR1	PURLINS - PFETTEN 4930 	1	80x200	6100
PR3	PURLINS - PFETTEN 4930 	1	80x200	6100
PR5	PURLINS - PFETTEN 4930 	1	80x200	6100
PR6	PURLINS - PFETTEN 3930 	1	80x200	6100
PR2	PURLINS - PFETTEN 3930 	1	80x200	6100
PR4	PURLINS - PFETTEN 1930 	1	80x200	6100
	ROOF BOARDS - DACHBRETTER 	214+4	113x18	3489
	FLOOR BOARDS - FUSSBODENBRETTER 	26+2	113x28	6000
	FLOOR BOARDS - FUSSBODENBRETTER 	13	113x28	5785
	FLOOR BOARDS - FUSSBODENBRETTER 	13	113x28	4925
	FLOOR BOARDS - FUSSBODENBRETTER 	47	113x28	3925
	FLOOR BOARDS - FUSSBODENBRETTER 	11	113x28	1925
	FLOOR BOARDS - FUSSBODENBRETTER 	13	113x28	1855
	FLOOR BOARDS - FUSSBODENBRETTER 	14	113x28	995
	FLOOR BOARDS - FUSSBODENBRETTER 	26	113x28	855
	Ceiling mouldings - Deckenleisten 		15x28	66 rm/lfm
	Floor mouldings - Fussbodenleisten 		14x55	71 rm/lfm
RLA 01-1	Eave board - Traufenbrett 18x95 	6	18x95	4012
Kood	Valencia 620x1120 70	Materjal	File	G0262 Valencia 620x1120 70.dwg



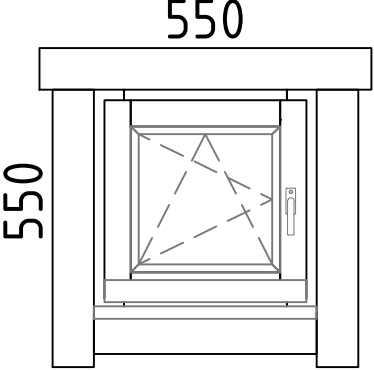

Pos	Model Valencia 620x1120 70		Pcs	Profile (mm)	Length (mm)
RLI01-1	Eave slat - Traufenleiste 18x40		4	18x40	6000
VLA 02-1	Gable board - Giebelbrett 18x120	13° 	4	18x120	3589
VLA 01-1	Gable board - Giebelbrett 18x95	13° 	4	18x95	3589
VKL 02-1	Gable cover slat - Giebeldeckleiste 18x58		4	18x58	3489
VLI 02-1	Gable slat - Giebelleiste 18x58	13° 	4	18x58	3489
TH01-1	Seal tape - Dichtungsband		1		35000
	T-strip - T-Leiste 70		4		480
	T-strip - T-Leiste 70		8		1020
	T-strip - T-Leiste 70		8		1155
	T-strip - T-Leiste 70		2		1965
	T-strip - T-Leiste 70		8		2033
	T-strip - T-Leiste 70		2		2100
ÜV1	Metal bar - Metallstange Ø10		1	Ø10	1240
ÜV2	Metal bar - Metallstange Ø10		3	Ø10	1170
ÜV3	Metal bar - Metallstange Ø10		1	Ø10	1100
ÜV4	Metal bar - Metallstange Ø10		10	Ø10	1040
ÜV5	Metal bar - Metallstange Ø10		2	Ø10	900
ÜV6	Metal bar - Metallstange Ø10		7	Ø10	360
ML01	Connecting strip for wall logs - Verbindungsstreifen für Wandbalken		20		
GD01	Diamond - Diamant		2		
LK	Hit block - Schlaghölzer		3		
N-0 2501	Nails - Nägel vierkant 2.5x50 for ceiling boards - für Dachbretter		1712		
N-0 2504	Nails - Nägel vierkant 2.5x50 for support tile - für Fliese		6		
N-0 2502	Nails - Nägel vierkant 2.5x60 for floor boards - für Fussbodenbretter		2584		
KR-0 3001	Screws - Schrauben 3.0x30 for ceiling mouldings - für Deckenleisten		164		
Kood	Valencia 620x1120 70	Materjal	File	G0262 Valencia 620x1120 70.dwg	17

Pos	Model Valencia 620x1120 70		Pcs	Profile (mm)	Length (mm)
KR-0 3002	Screws - Schrauben 3.0x30 for eave slats - für Traufenleisten		48		
KR-0 3003	Screws - Schrauben 3.0x30 for floor mouldings - für Fussbodenleisten		148		
KR-0 3522	Screws - Schrauben 3.5x45 C3 for connecting strip for wall logs - für Verbindungsstreifen für Wandbalken		80		
KR-0 3523	Screws - Schrauben 3.5x45 C3 for diamonds - für Diamanten		4		
KR-0 3525	Screws - Schrauben 3.5x45 C3 for eave boards - für Traufenbretter		48		
KR-0 3527	Screws - Schrauben 3.5x45 C3 for gable boards - für Giebelbretter		64		
KR-0 3521	Screws - Schrauben 3.5x45 C3 for gable cover slats - für Giebeldeckleisten		32		
KR-0 3528	Screws - Schrauben 3.5x45 C3 for gable slats - für Giebelleisten		32		
KR-0 5080	Screws - Schrauben 5.0x100 for foundation beams - für Fundamenthölzer		240		
TPL01	Support tile - Fliese		6		
KL03-1	Threaded rod for purlins - Gewindestange für die Pfetten M12		6		210
KL1	Threaded rod - Gewindestange M8		9		2000
KL2	Threaded rod - Gewindestange M8		9		528
KL3	Threaded rod - Gewindestange M8		16		349
M03	Nut for purlins - Mutter für die Pfetten M12		12		
SE32	Washer for purlins - Scheibe für die Pfetten M12x37		12		
	Nut - Mutter M8		25		
	Washer - Scheibe M8x24		25		
	Extended nut - Langmutter M8		9		
	Drive-in nut - Einschlagmutter M8		25		
Kood	Valencia 620x1120 70	Materjal	File	G0262 Valencia 620x1120 70.dwg	17

Pos	Model Valencia 620x1120 70	Pcs	Profile (mm)	Length (mm)	
	<p>WINDOW 1546x1180 W5-D70P-06T-15461180</p>  <p><u>W206-PT</u> Right handed - DIN rechts Tempered glass - Gehärtetes Glas Opens inside - Öffnet innen</p>	8			
VIHM 01-1	Rain deflector - Regenabweiser		8	36x134	1756
KR-0 3524	Screws - Schrauben 3.5x45 C3 for door and window trims - für Tür- und Fensterleisten		224		
KR-0 4001	Screws - Schrauben 4.0x60 C3 for rain deflector - für Regenabweiser		40		
Kood	Valencia 620x1120 70	Materjal	File	G0262 Valencia 620x1120 70.dwg	17

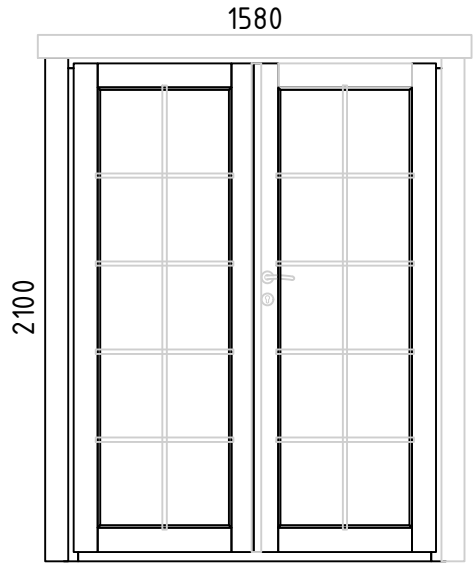
Pos	Model Valencia 620x1120 70	Pcs	Profile (mm)	Length (mm)	
	<p>WINDOW 550x550 W5-S70P-0XT-05500550</p>  <p><u>W101-PT</u></p> <p>Right handed - DIN rechts Tempered glass - Gehärtetes Glas Opens inside - Öffnet innen</p>	1			
VIHM 01-2	Rain deflector - Regenabweiser		1	36x134	760
KR-0 3524	Screws - Schrauben 3.5x45 C3 for door and window trims - für Tür- und Fensterleisten		20		
KR-0 4001	Screws - Schrauben 4.0x60 C3 for rain deflector - für Regenabweiser		3		
Kood	Valencia 620x1120 70	Materjal	File	G0262 Valencia 620x1120 70.dwg	17

Pos	Model Valencia 620x1120 70	Pcs	Profile (mm)	Length (mm)
	WINDOW 550x550 W5-S70V-0XT-05500550  <p style="margin-left: 20px;">550</p> <p style="margin-left: 10px;">550</p> <p style="margin-left: 20px;"><u>W101-VT</u></p> <p>Left handed - DIN rechts Tempered glass - Gehärtetes Glas Opens inside - Öffnet innen</p>	1		
VIHM 01-2	Rain deflector - Regenabweiser	 1	36x134	760
KR-0 3524	Screws - Schrauben 3.5x45 C3 for door and window trims - für Tür- und Fensterleisten	 20		
KR-0 4001	Screws - Schrauben 4.0x60 C3 for rain deflector - für Regenabweiser	 3		
Kood	Valencia 620x1120 70	Materjal	File G0262 Valencia 620x1120x70.dwg/17	

Pos	Model Valencia 620x1120 70	Pcs	Profile (mm)	Length (mm)
	DOOR 1580x2100 D5-D70R-01T-15802100  D202-RT Right handed - DIN rechts Tempered glass - Gehärtetes Glas Opens outside - Öffnet aussen	1		
VIHM 01-3	Rain deflector - Regenabweiser		36x134	1794
KR-0 3524	Screws - Schrauben 3.5x45 C3 for door and window trims - für Tür- und Fensterleisten			28
KR-0 4001	Screws - Schrauben 4.0x60 C3 for rain deflector - für Regenabweiser			4
Kood	Valencia 620x1120 70	Materjal	File	G0262 Valencia 620x1120 70.dwg 17

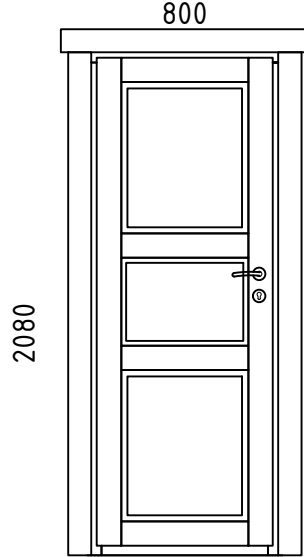
Pos	Model Valencia 620x1120 70	Pcs	Profile (mm)	Length (mm)
	<p data-bbox="798 163 1197 252">DOOR 800x2080 D5-I70L-XXX-08002080</p>  <p data-bbox="903 281 1365 445">D913-LX Left handed - DIN rechts Opens outside - Öffnet aussen</p>	1		

KR-0 3524	Screws - Schrauben 3.5x45 C3 for door and window trims - für Tür- und Fensterleisten		26	
--------------	--	---	----	--

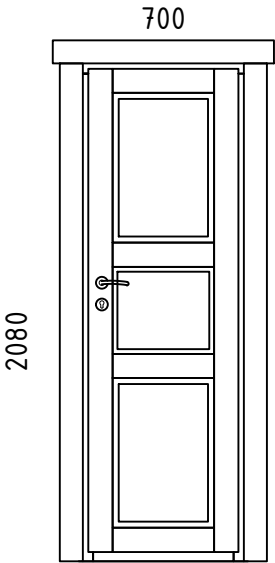
Pos	Model Valencia 620x1120 70	Pcs	Profile (mm)	Length (mm)
	DOOR 700x2080 D5-I70R-XXX-07002080  D914-RX Right handed - DIN rechts Opens outside - Öffnet aussen	1		
KR-0 3524	Screws - Schrauben 3.5x45 C3 for door and window trims - für Tür- und Fensterleisten	26		
Kood	Valencia 620x1120 70	Materjal	File	G0262 Valencia 620x1120 70.dwg 15/17

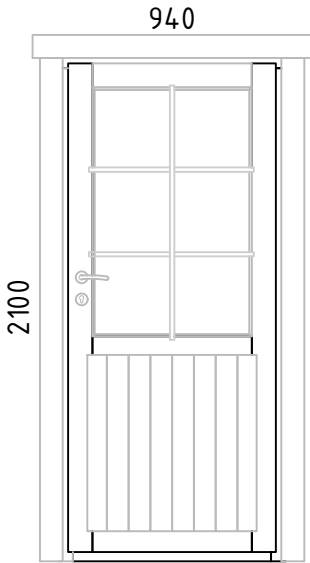
Pos	Model Valencia 620x1120 70	Pcs	Profile (mm)	Length (mm)
	DOOR 940x2100 D5-S70R-56T-09402100  D101-RT Right handed - DIN rechts Tempered glass - Gehärtetes Glas Opens outside - Öffnet aussen	1		
VIHM 01-4	Rain deflector - Regenabweiser	1	36x134	1154
KR-0 3524	Screws - Schrauben 3.5x45 C3 for door and window trims - für Tür- und Fensterleisten	26		
KR-0 4001	Screws - Schrauben 4.0x60 C3 for rain deflector - für Regenabweiser	3		
Kood	Valencia 620x1120 70	Materjal	File G0262 Valencia 620x1120 70.dwg	17/17

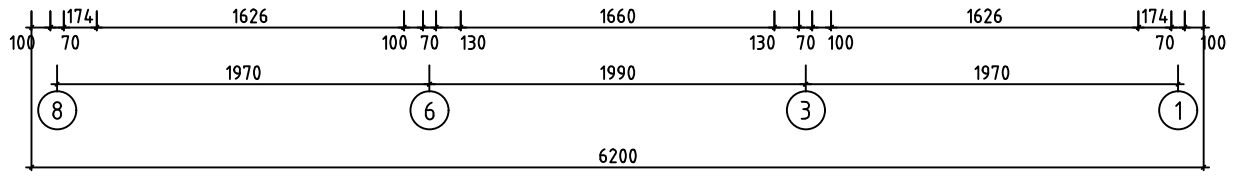
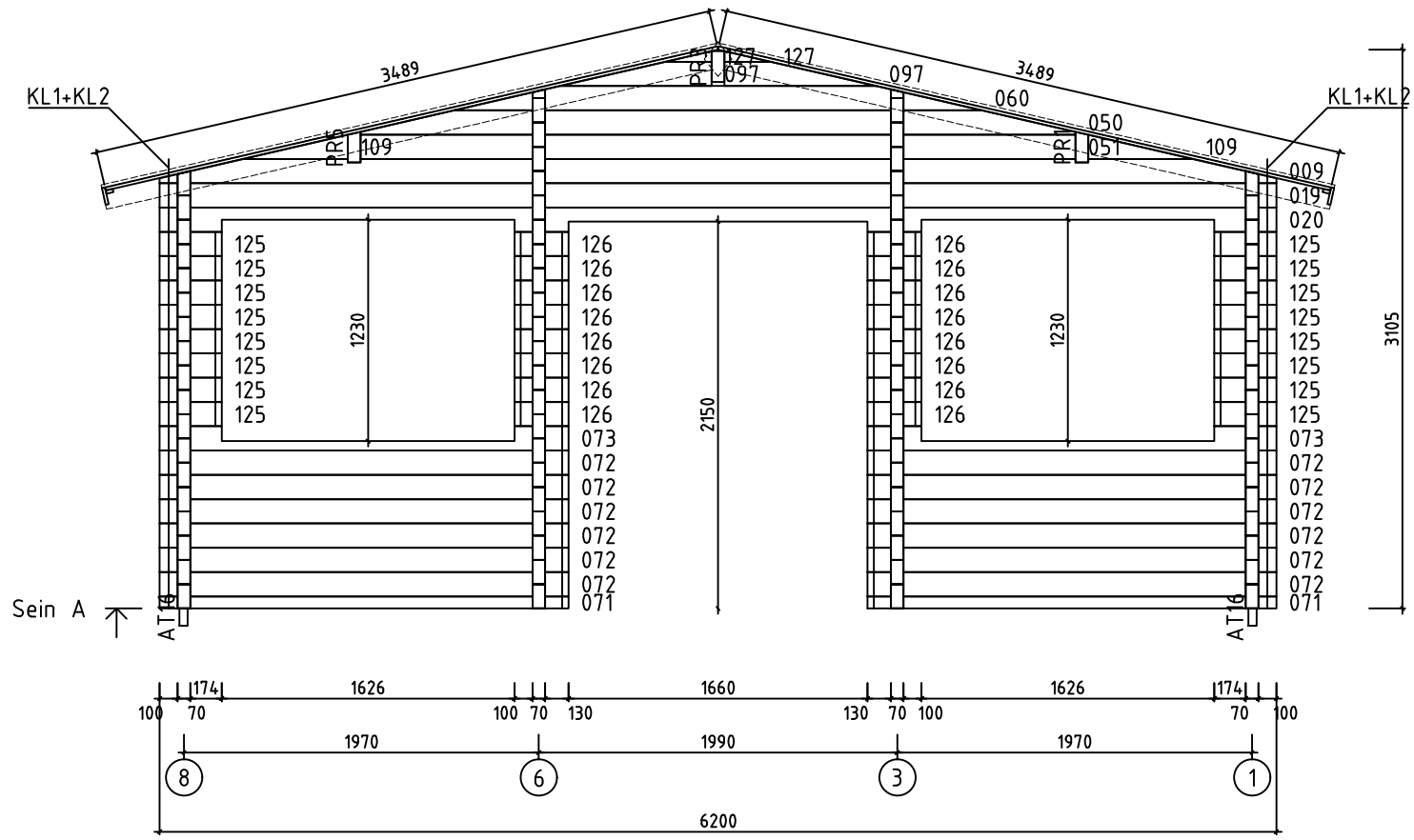

 www.hansa24.com	Name		Valencia 620x1120 70		SKU		G0262
	Drawing/Zeichnung		Wall/Wand A		Format		A4
	Profile/Profil	7x13.5	Scale/Maßstab	1:40	Date	22.09.2022	

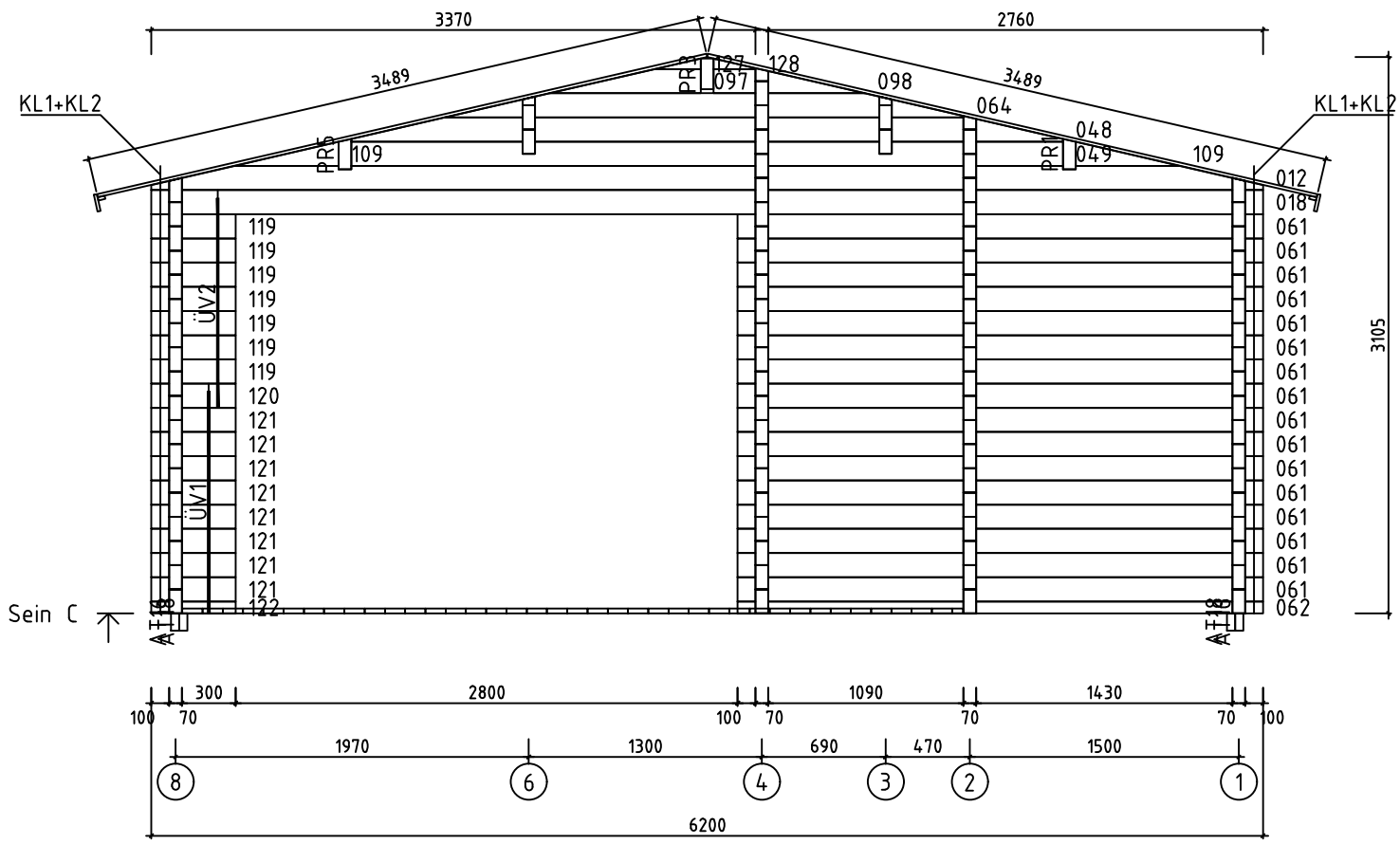

Name	Valencia 620x1120 70		SKU	G0262	
Drawing/Zeichnung	Wall/Wand C		Format	A4	
Profile/Profil	7x13.5	Scale/Maßstab	1:40	Date	22.09.2022

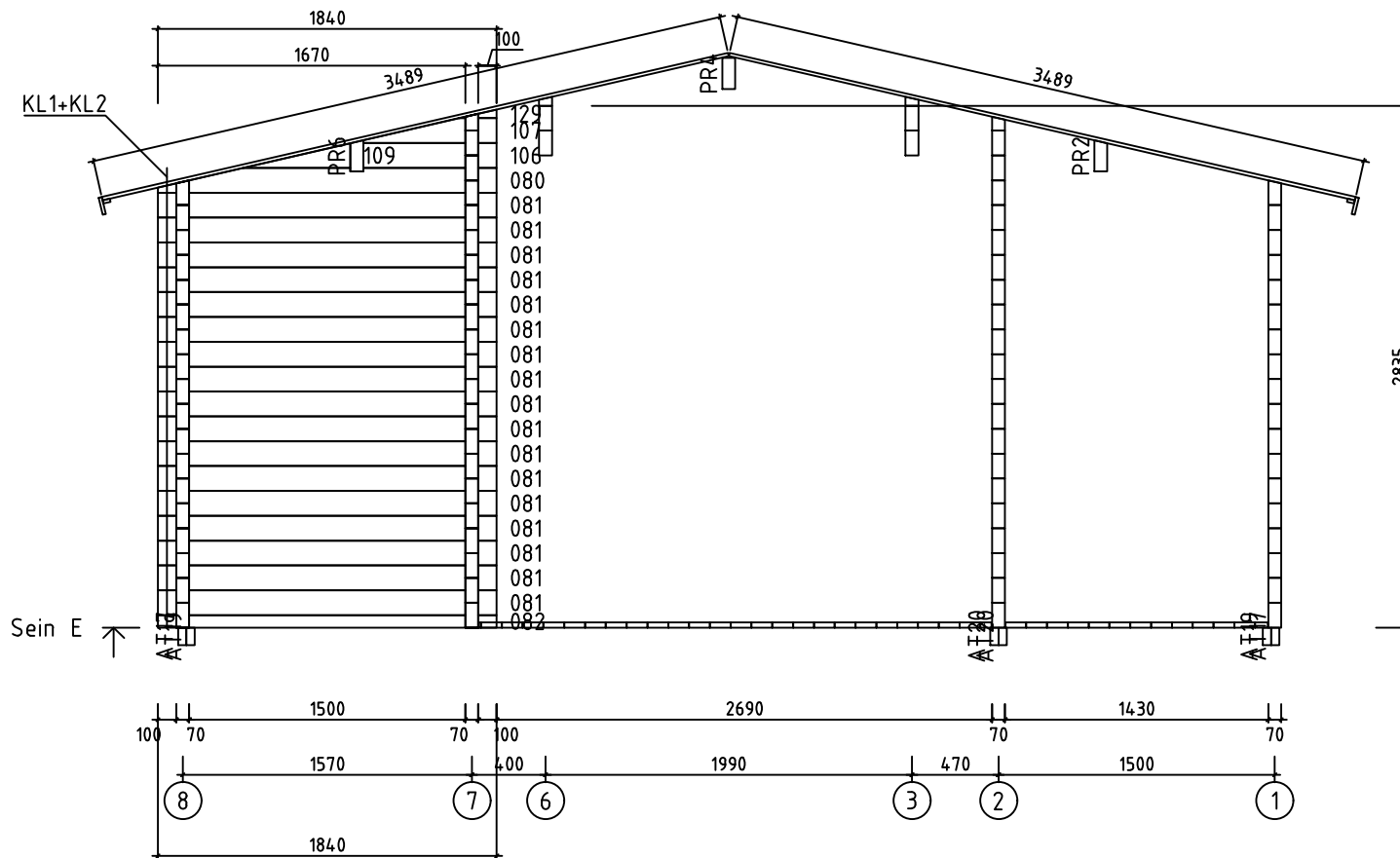

 www.hansa24.com	Name		Valencia 620x1120 70		SKU	G0262
	Drawing/Zeichnung		Wall/Wand E		Format	A4
	Profile/Profil	7x13.5	Scale/Maßstab	1:40	Date	22.09.2022

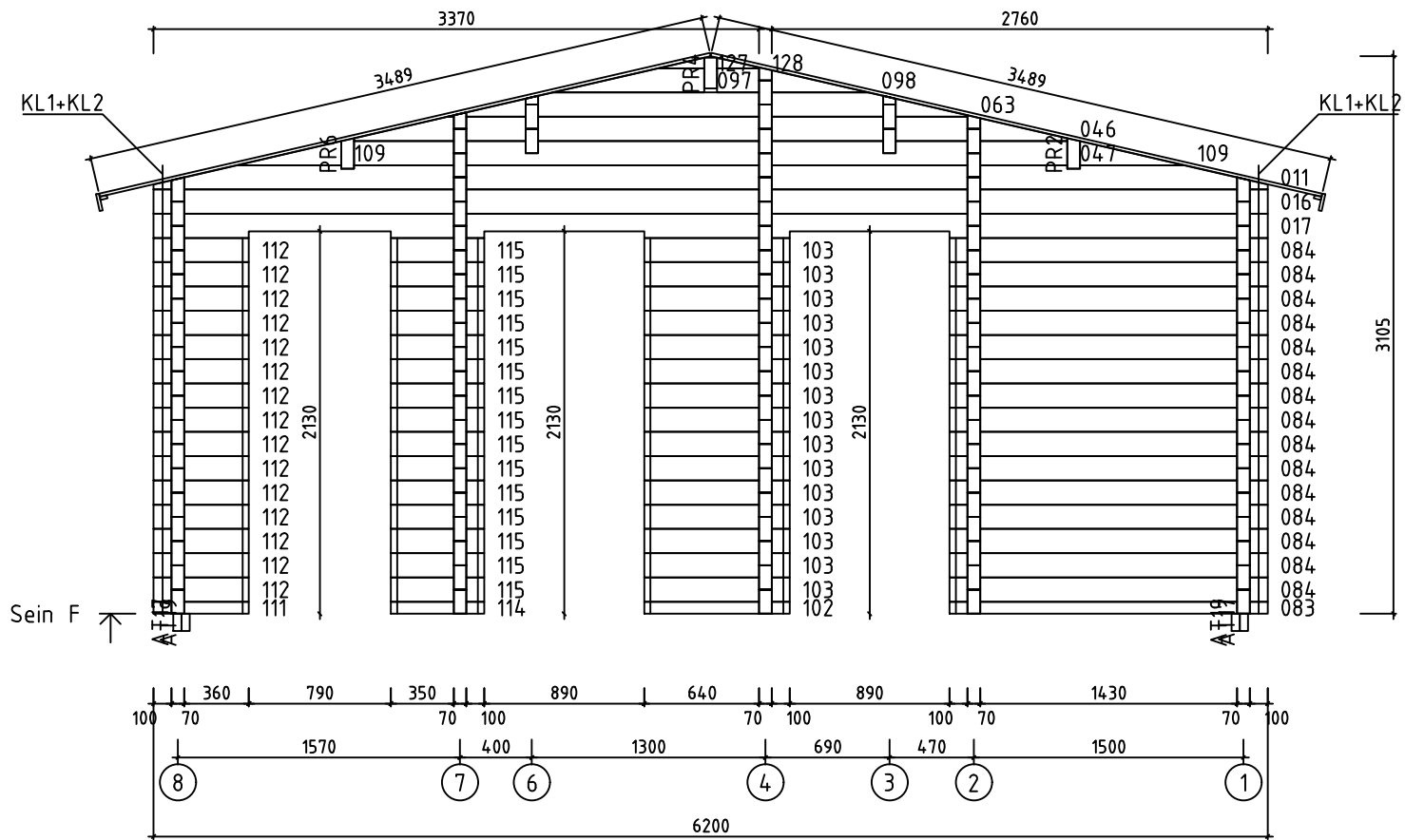

Name	Valencia 620x1120 70		SKU	G0262	
Drawing/Zeichnung	Wall/Wand F		Format	A4	
Profile/Profil	7x13.5	Scale/Maßstab	1:40	Date	22.09.2022

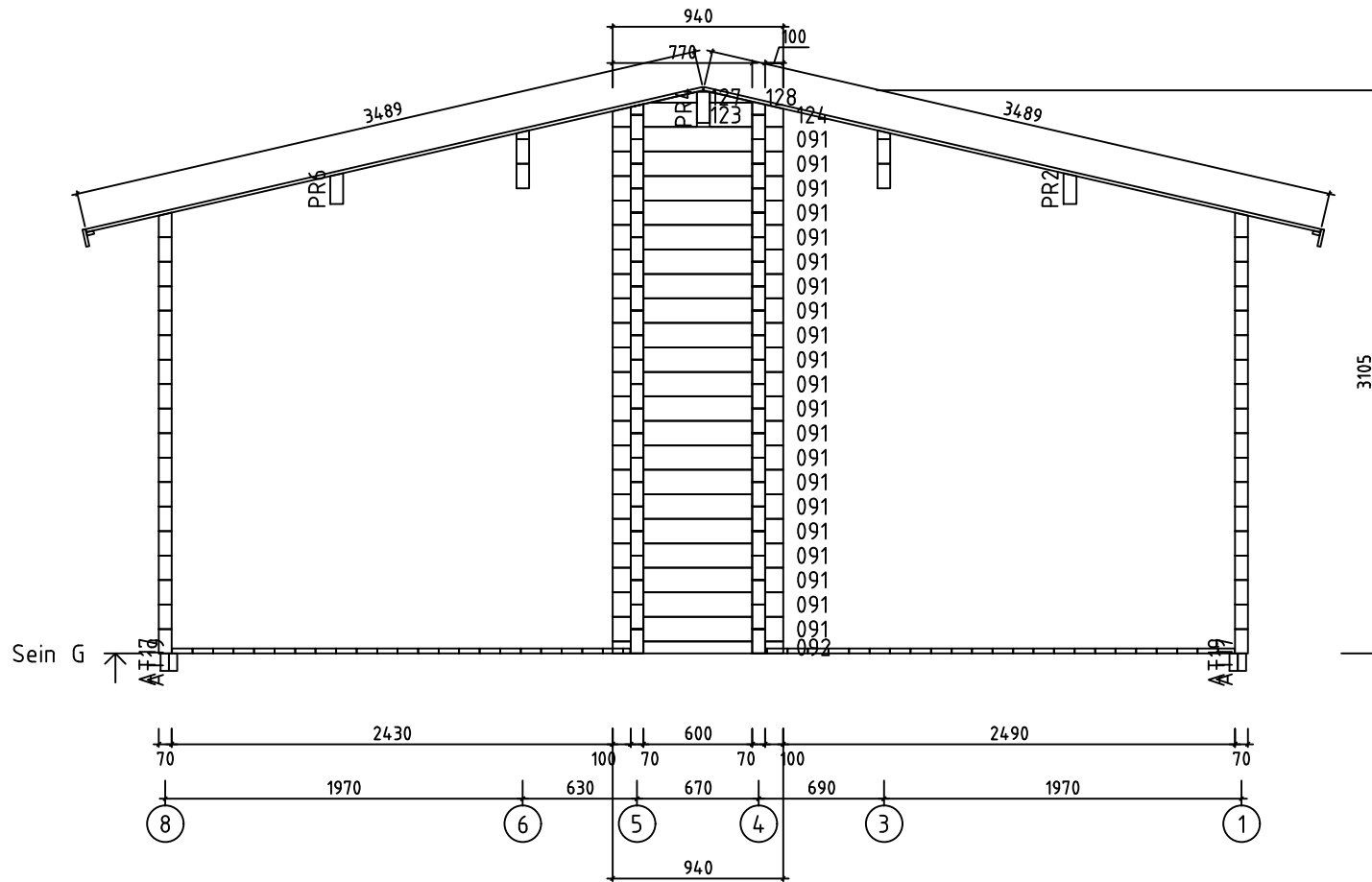

 www.hansa24.com	Name		Valencia 620x1120 70		SKU	G0262
	Drawing/Zeichnung		Wall/Wand G		Format	A4
	Profile/Profil	7x13.5	Scale/Maßstab	1:40	Date	22.09.2022

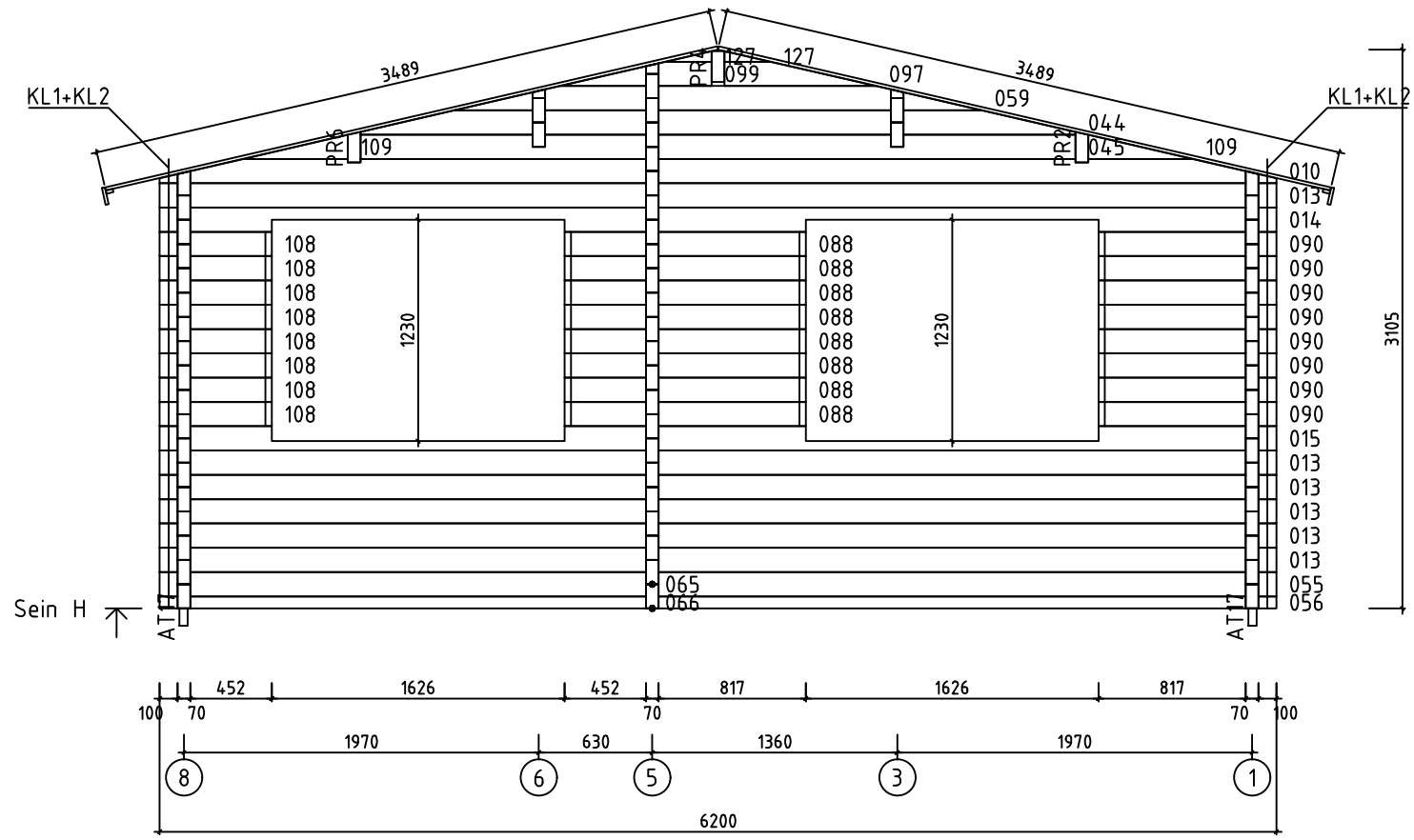

Name	Valencia 620x1120 70		SKU	G0262	
Drawing/Zeichnung	Wall/Wand H		Format	A4	
Profile/Profil	7x13.5	Scale/Maßstab	1:40	Date	22.09.2022

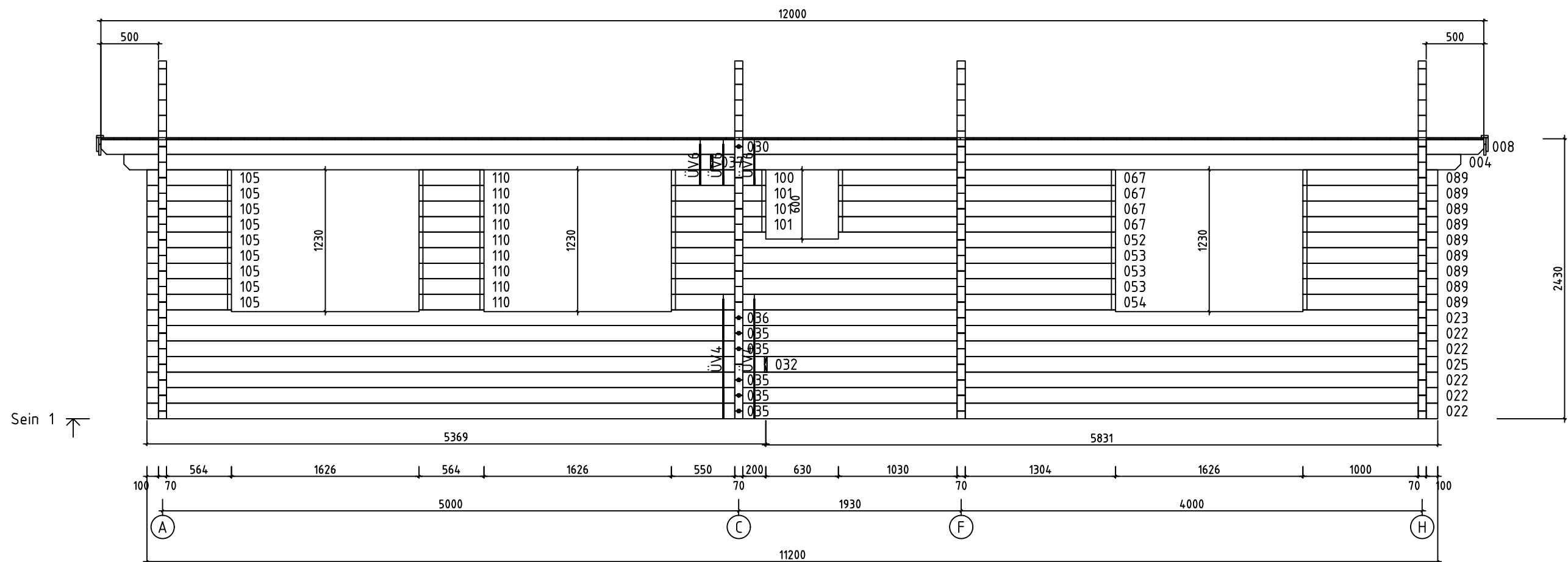

 www.hansa24.com	Name Valencia 620x1120 70		SKU G0262
	Drawing/Zeichnung Wall/Wand 1		Format A3
	Profile/Profil 7x13.5	Scale/Maßstab 1:40	Date 22.09.2022

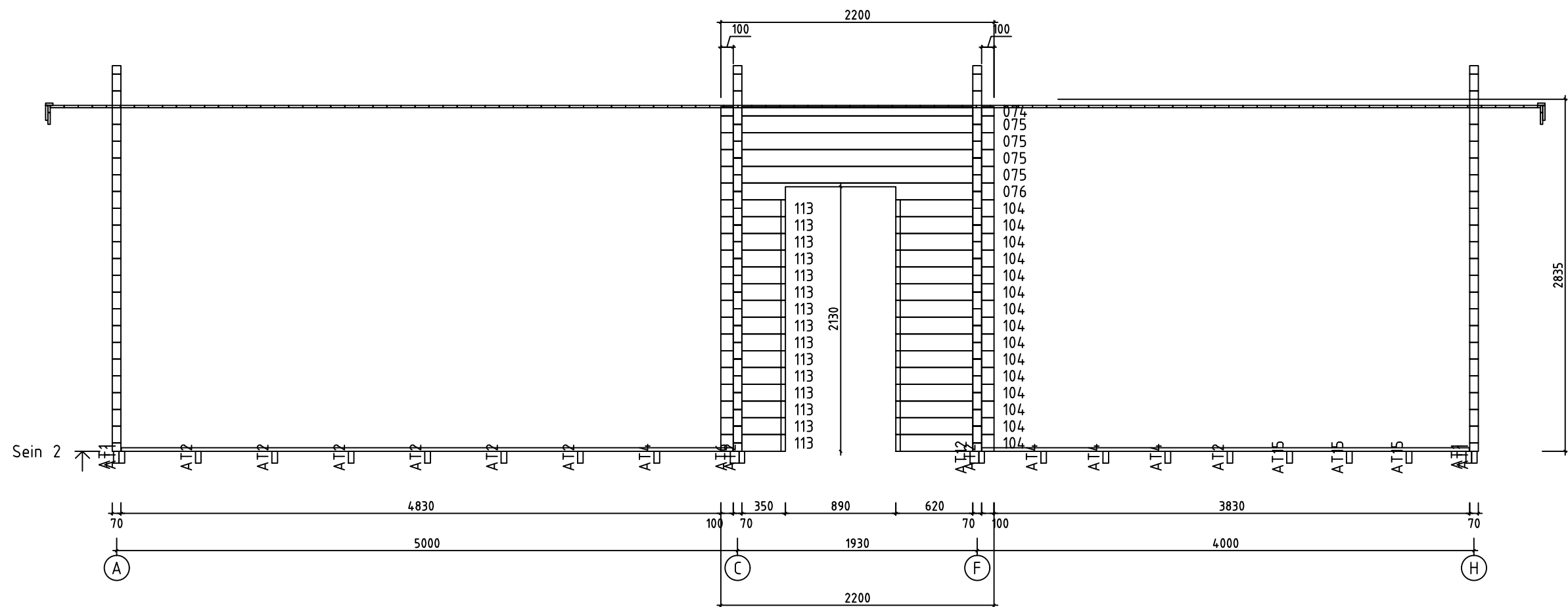

 www.hansa24.com	Name		Valencia 620x1120 70	SKU	G0262
	Drawing/Zeichnung		Wall/Wand 2	Format	A3
	Profile/Profil	7x13.5	Scale/Maßstab	1:40	Date

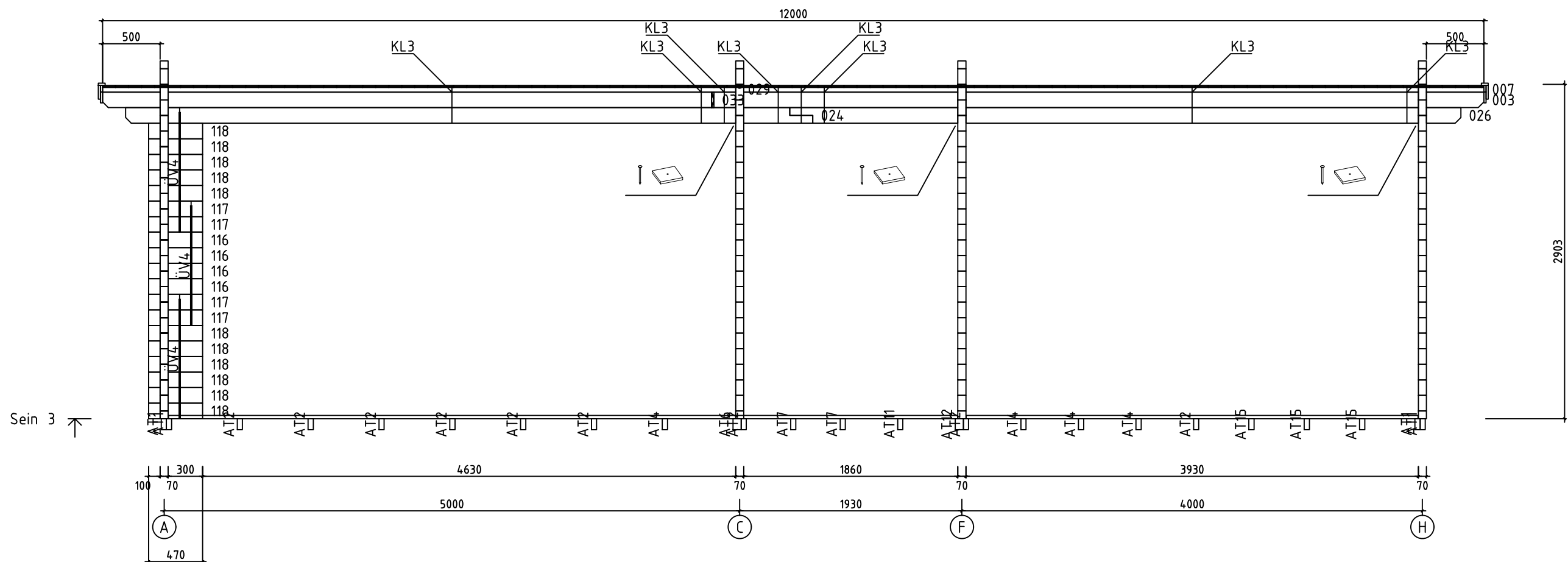

 www.hansa24.com	Name Valencia 620x1120 70		SKU G0262
	Drawing/Zeichnung Wall/Wand 3		Format A3
	Profile/Profil 7x13.5	Scale/Maßstab 1:40	Date 22.09.2022

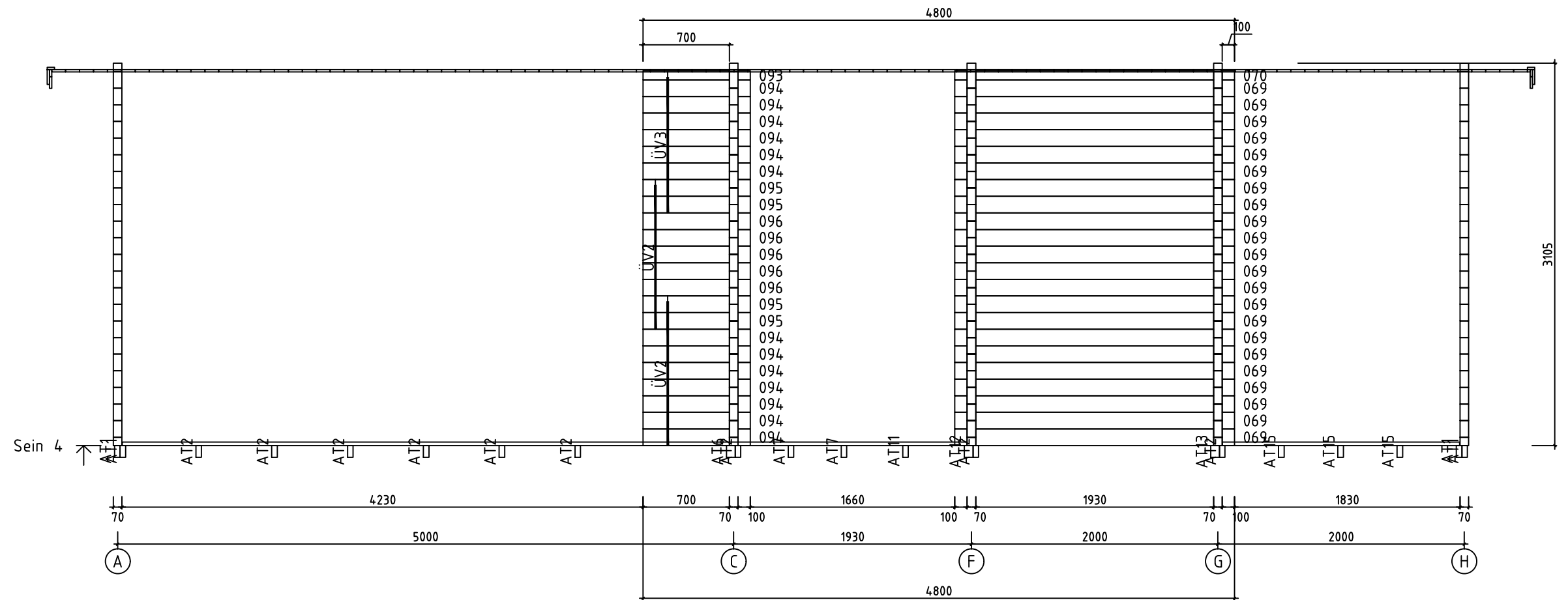

 www.hansa24.com	Name Valencia 620x1120 70		SKU G0262
	Drawing/Zeichnung Wall/Wand 4		Format A3
	Profile/Profil 7x13.5	Scale/Maßstab 1:40	Date 22.09.2022

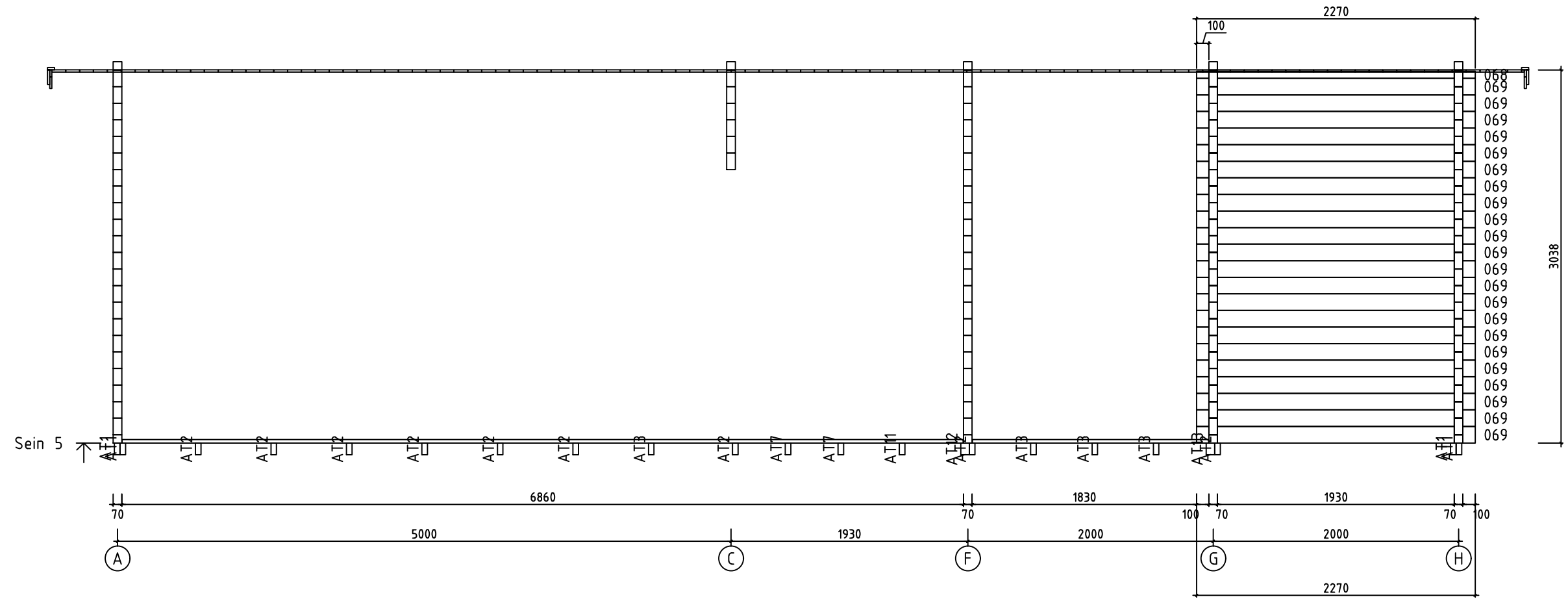

 www.hansa24.com	Name		Valencia 620x1120 70	SKU	G0262
	Drawing/Zeichnung		Wall/Wand 5	Format	A3
	Profile/Profil	7x13.5	Scale/Maßstab	1:40	Date

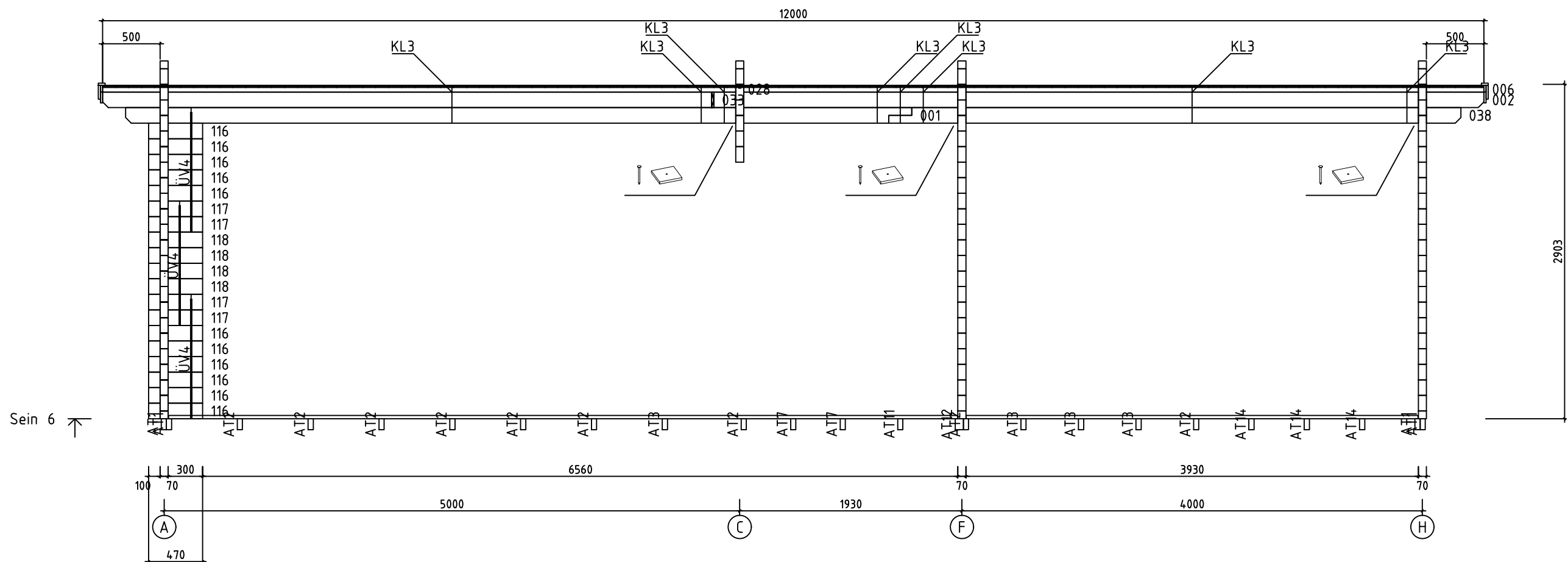

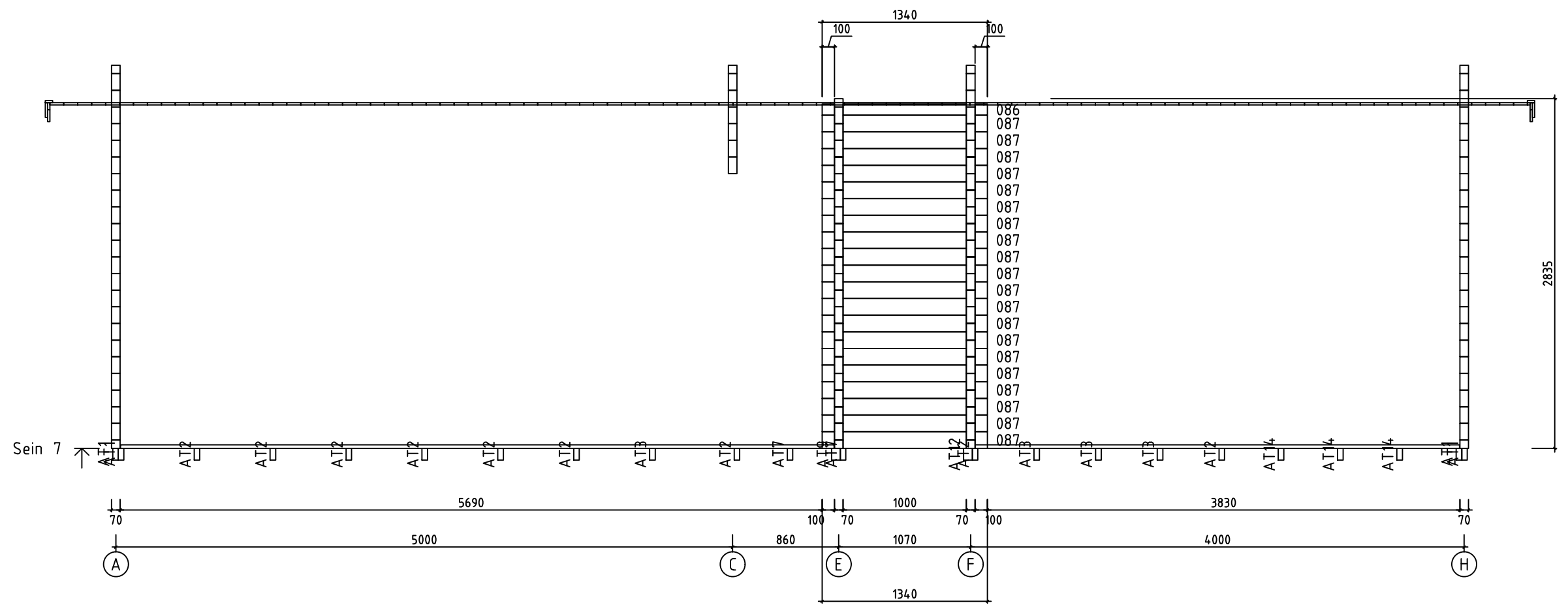

 www.hansa24.com	Name Valencia 620x1120 70		SKU G0262
	Drawing/Zeichnung Wall/Wand 6		Format A3
	Profile/Profil 7x13.5	Scale/Maßstab 1:40	Date 22.09.2022

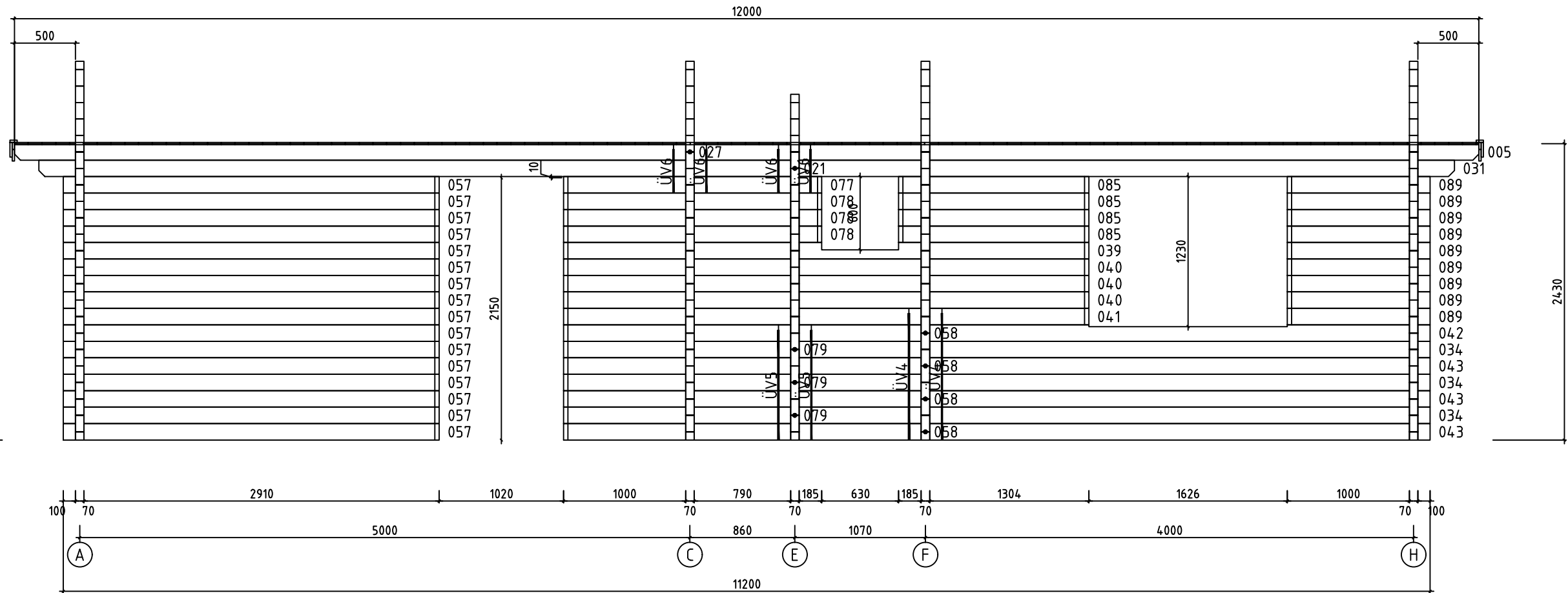

 www.hansa24.com	Name		Valencia 620x1120 70	SKU	G0262
	Drawing/Zeichnung		Wall/Wand 7	Format	A3
	Profile/Profil	7x13.5	Scale/Maßstab	1:40	Date

Sein 8 ↗



 www.hansa24.com	Name Valencia 620x1120 70		SKU G0262
	Drawing/Zeichnung Wall/Wand 8		Format A3
	Profile/Profil 7x13.5	Scale/Maßstab 1:40	Date 22.09.2022