

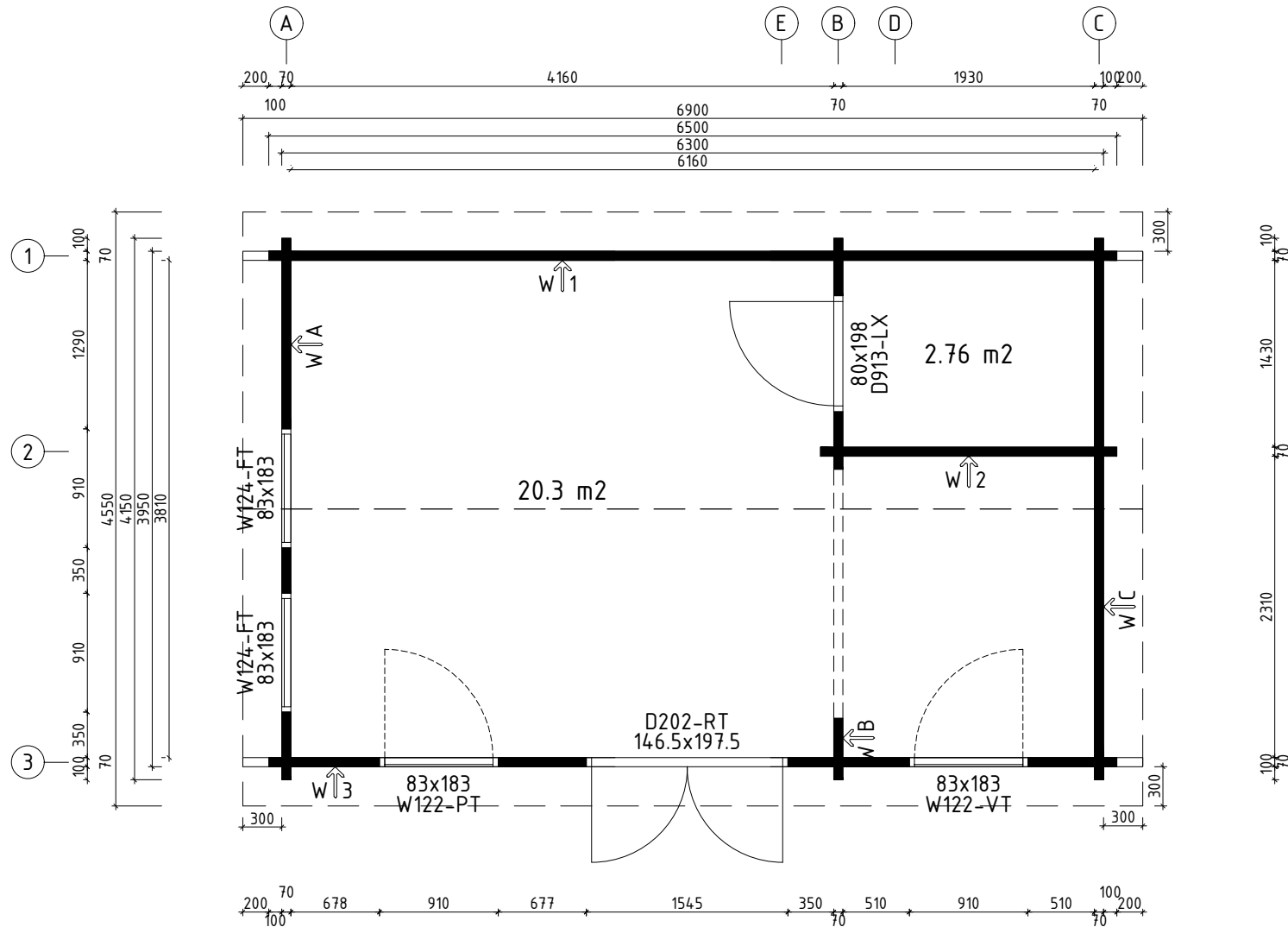

Name	Sweden A 415x650 70	SKU	G0265	
Drawing/Zeichnung	3D	Format	A4	
Profile/Profil	7x13.5	Scale/Maßstab	Date	21.02.2023

H = 1.800 m
TOTAL: 23.06 m²







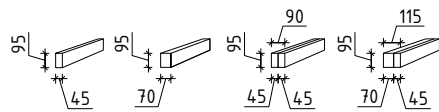
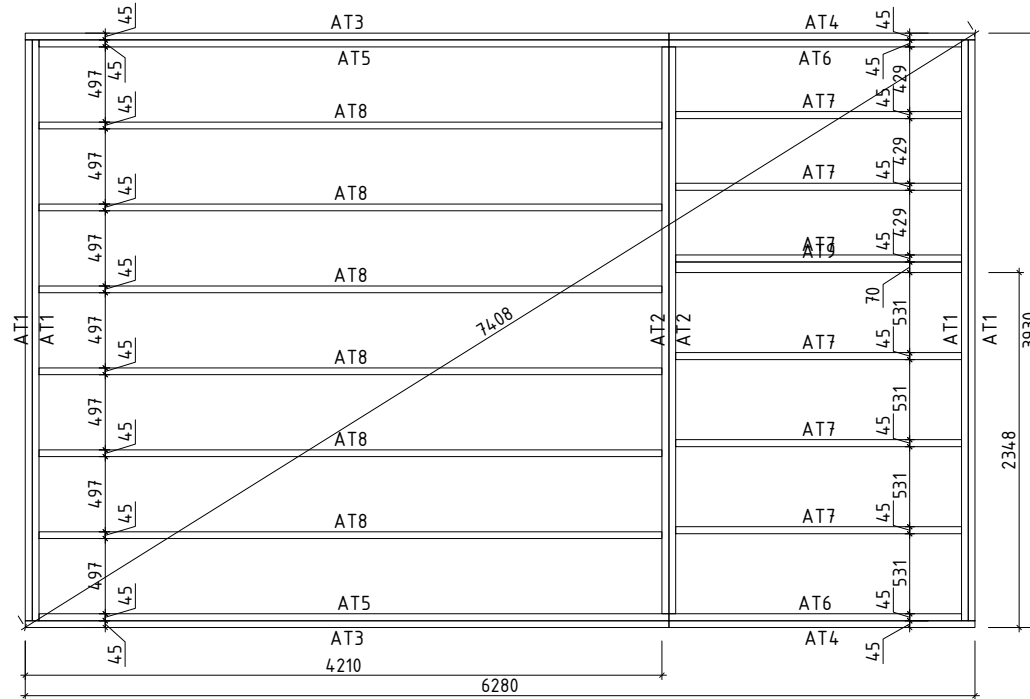



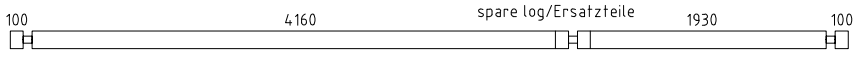
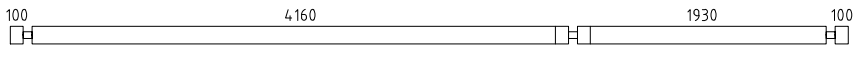
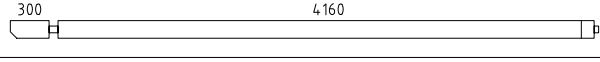
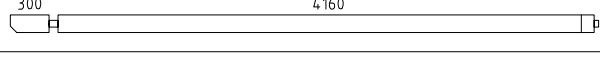
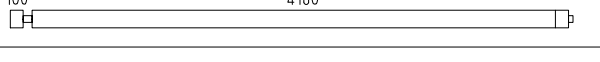
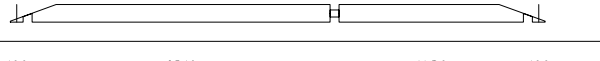
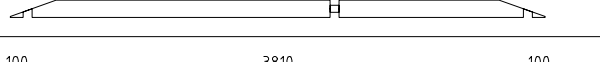
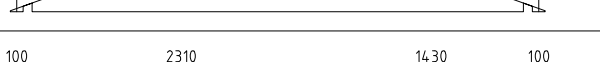
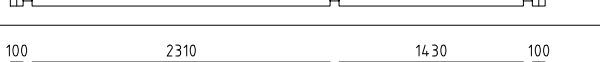
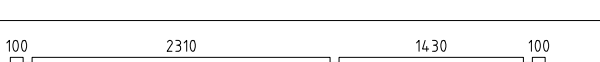
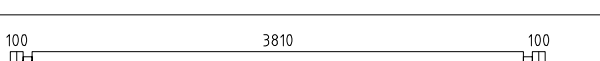
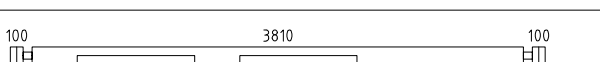
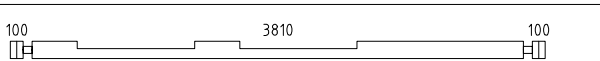
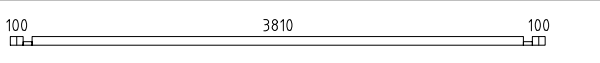
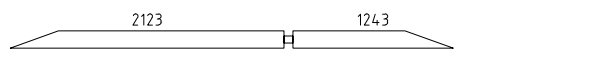
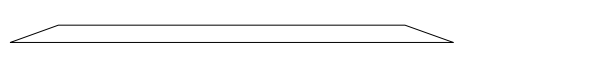
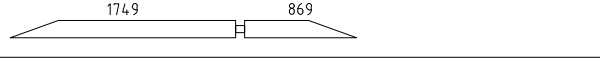
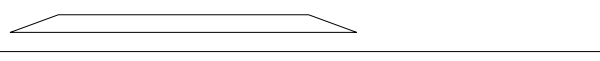
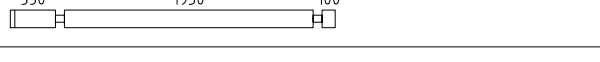
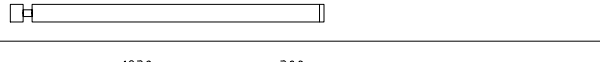
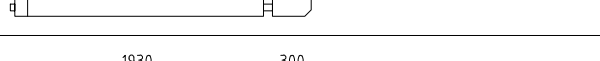
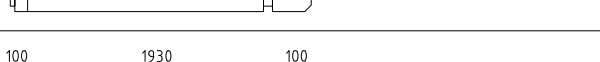
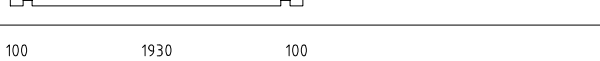
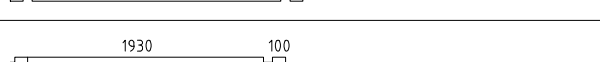
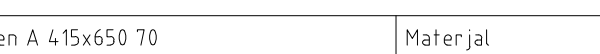



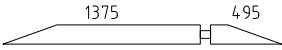
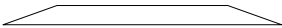
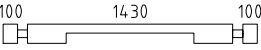
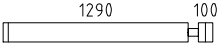
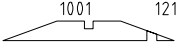

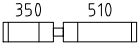
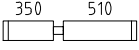
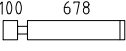
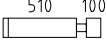
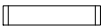

Opening and fixed window positions can be interchanged.
Positionen für feststehende Fenster und Fenster zum
Offnen können miteinander getauscht werden.





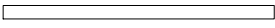
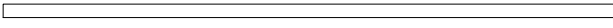

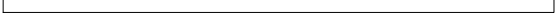

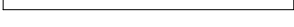

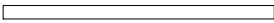

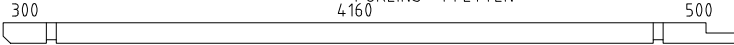
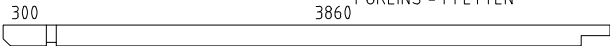
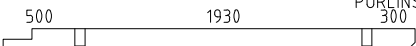
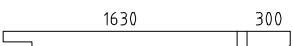

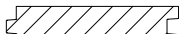

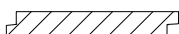

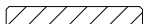

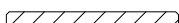
 www.hansa24.com	Name		Sweden A 415x650 70		SKU		G0265
	Drawing/Zeichnung		Plan_Grundplan		Format		A4
	Profile/Profil	7x13.5	Scale/Maßstab	1:50	Date	21.02.2023	













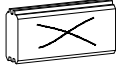

















 www.hansa24.com	Name		Sweden A 415x650 70		SKU		G0265	
	Drawing/Zeichnung		Foundation plan_Lagerholzplan			Format		A4
	Profile/Profil		7x13.5	Scale/Maßstab		1:50	Date	



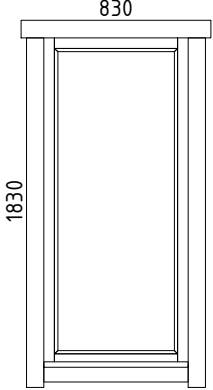

Pos	Model Sweden A 415x650 70	Pcs	Profile (mm)	Length (mm)
	Notice! The gable pieces can be partly pre-assembled! Please notice - those differ from the description given in the specification list.			
	Achtung! Die Giebelbohlen können teilweise schon vormontiert sein! Bitte beachten - diese erscheinen nicht ganz so wie in der Teilleiste beschrieben.			
001	 spare log/Ersatzteile	1	70x135	6500
001		6	70x135	6500
002		1	70x135	4565
003		1	70x135	4565
004		11	70x135	4365
005		1	70x135	4150
006		1	70x135	4150
007		1	70x135	4150
008		16	70x135	4150
009		1	70x68	4150
010		1	70x135	4150
011		1	70x135	4150
012		1	70x135	4150
013		1	70x135	4150
014		1	70x68	4150
015		2	70x135	3436
016		1	70x135	3436
017		2	70x135	2688
018		1	70x135	2688
019		1	70x135	2520
020		1	70x135	2435
021		1	70x135	2335
022		1	70x135	2335
023		1	70x135	2270
024		20	70x135	2270
025		11	70x135	2135
Kood	Sweden A 415x650 70	Materjal	File	G0265 Sweden A 415x650 70.dwg



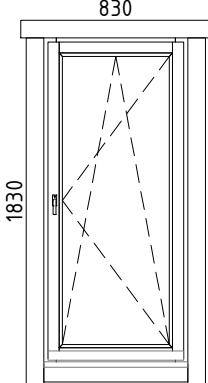

Pos	Model Sweden A 415x650 70	Pcs	Profile (mm)	Length (mm)
026		2	70x135	1940
027		1	70x135	1940
028		1	70x135	1770
029		13	70x135	1460
030		2	70x135	1192
031		1	70x135	1192
032		1	70x135	930
033		13	70x135	930
034		14	70x135	848
035		14	70x135	680
036		14	70x135	677
037		13	70x135	520
038		1	70x68	470
039		15	70x135	470
040		2	70x68	440
041		28	70x135	440
042		13	70x135	350
043		6	70x68	192
AT9	FOUNDATION BEAMS (impregnated) - FUNDAMENTHÖLZER (imprägniert) 	1	70x95	1890
AT3	FOUNDATION BEAMS (impregnated) - FUNDAMENTHÖLZER (imprägniert) 	2	45x95	4255
AT5	FOUNDATION BEAMS (impregnated) - FUNDAMENTHÖLZER (imprägniert) 	2	45x95	4165
AT8	FOUNDATION BEAMS (impregnated) - FUNDAMENTHÖLZER (imprägniert) 	6	45x95	4120
AT1	FOUNDATION BEAMS (impregnated) - FUNDAMENTHÖLZER (imprägniert) 	4	45x95	3840
AT2	FOUNDATION BEAMS (impregnated) - FUNDAMENTHÖLZER (imprägniert) 	2	45x95	3750
AT4	FOUNDATION BEAMS (impregnated) - FUNDAMENTHÖLZER (imprägniert) 	2	45x95	2025
Kood	Sweden A 415x650 70	Materjal	File	G0265 Sweden A 415x650 70.dwg

Pos	Model Sweden A 415x650 70		Pcs	Profile (mm)	Length (mm)
AT6	FOUNDATION BEAMS (impregnated) - FUNDAMENTHÖLZER (imprägniert) 		2	45x95	1935
AT7	FOUNDATION BEAMS (impregnated) - FUNDAMENTHÖLZER (imprägniert) 		6	45x95	1890
LI1	SLAT - LEISTE 		1	58x18	1910
PR3	PURLINS - PFETTEN 300 4160 500 		2	70x145	5100
PR1	PURLINS - PFETTEN 300 3860 		3	70x145	4230
PR2	PURLINS - PFETTEN 500 1930 300 		3	70x145	2870
PR4	PURLINS - PFETTEN 1630 300 		2	70x145	2000
	ROOF BOARDS - DACHBRETTER		124+2	113x18	2419
	FLOOR BOARDS - FUSSBODENBRETTER		37+1	113x28	3805
	FLOOR BOARDS - FUSSBODENBRETTER		18	113x28	2305
	FLOOR BOARDS - FUSSBODENBRETTER		18	113x28	1425
	Ceiling mouldings - Deckenleisten (inside and outside - innen und außen)			15x28	63 rm/lfm
	Floor mouldings - Fussbodenleisten			14x55	28 rm/lfm
RLA 01-1	Eave board - Traufenbrett 18x95		4	18x95	3450
RLI01-1	Eave slat - Traufenleiste 18x40			18x40	14.8 rm/lfm
VLA 02-1	Gable board - Giebelbrett 18x120	19.8° 	4	18x120	2519
VKL 02-1	Gable cover slat - Giebeldeckleiste 18x58		4	18x58	2519
TH01-1	Seal tape (upper log on sidewalls) - Dichtungsband (letzte bohlenkranz seitenwänder)		1		14 rm/lfm
	T-strip - T-Leiste 70		4		1695
	T-strip - T-Leiste 70		4		1830
	T-strip - T-Leiste 70		2		1898
	T-strip - T-Leiste 70		2		1965
ÜV1	Metal bar - Metallstange Ø10		2	Ø10	1170
ÜV2	Metal bar - Metallstange Ø10		2	Ø10	1040
ÜV3	Metal bar - Metallstange Ø10		2	Ø10	360
Kood	Sweden A 415x650 70	Materjal	File	G0265 Sweden A 415x650 70.dwg	1/10



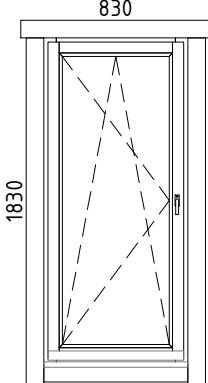

Pos	Model Sweden A 415x650 70		Pcs	Profile (mm)	Length (mm)
ML01	Connecting strip for wall logs - Verbindungsstreifen für Wandbalken		13		
GD01	Diamond - Diamant		2		
LK	Hit block - Schlaghölzer		3		
N-0 2503	Nails - Nägel 2.5x60 for floor boards - für Fussbodenbretter		1024		
N-0 2501	Nails - Nägel vierkant 2.5x50 for ceiling boards - für Dachbretter		992		
KR-0 3001	Screws - Schrauben 3.0x30 for ceiling mouldings - für Deckenleisten		108		
KR-0 3002	Screws - Schrauben 3.0x30 for eave slats - für Traufenleisten		28		
KR-0 3003	Screws - Schrauben 3.0x30 for floor mouldings - für Fussbodenleisten		62		
KR-0 3522	Screws - Schrauben 3.5x45 C3 for connecting strip for wall logs - für Verbindungsstreifen für Wandbalken		52		
KR-0 3523	Screws - Schrauben 3.5x45 C3 for diamonds - für Diamanten		4		
KR-0 3525	Screws - Schrauben 3.5x45 C3 for eave boards - für Traufenbretter		28		
KR-0 3527	Screws - Schrauben 3.5x45 C3 for gable boards - für Giebelbretter		48		
KR-0 3521	Screws - Schrauben 3.5x45 C3 for gable cover slats - für Giebeldeckleisten		24		
KR-0 3528	Screws - Schrauben 3.5x45 C3 for gable slats - für Giebelleisten		24		
KR-0 3530	Screws - Schrauben 3.5x45 C3 for slat - für leiste		4		
KR-0 5080	Screws - Schrauben 5.0x100 for foundation beams - für Fundamenthölzer		108		
KL1	Threaded rod - Gewindestange M8		4		2000
KL2	Threaded rod - Gewindestange M8		4		393
KL03-1	Threaded rod for purlins - Gewindestange für die Pfetten M12		10		150
M03	Nut for purlins - Mutter für die Pfetten M12		20		
SE32	Washer for purlins - Scheibe für die Pfetten M12x37		20		
	Nut - Mutter M8		4		
	Washer - Scheibe M8x24		4		
	Extended nut - Langmutter M8		4		
	Drive-in nut - Einschlagmutter M8		4		
Kood	Sweden A 415x650 70	Materjal	File	G0265 Sweden A 415x650 70.dwg	1/10

Pos	Model Sweden A 415x650 70	Pcs	Profile (mm)	Length (mm)	
	<p>WINDOW 830x1830 W5-S70F-0XT-08301830</p>  <p>830 1830</p> <p><u>W124-FT</u> Tempered glass - Gehärtetes Glas Fixed - Fix</p>	2			
VIHM 01-1	Rain deflector - Regenabweiser		2	36x134	1030
KR-0 3524	Screws - Schrauben 3.5x45 C3 for door and window trims - für Tür- und Fensterleisten		48		
KR-0 4001	Screws - Schrauben 4.0x60 C3 for rain deflector - für Regenabweiser		4		
Kood	Sweden A 415x650 70	Materjal	File	G0265 Sweden A 415x650 70.dwg	6/10

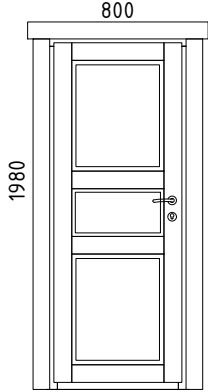
Pos	Model Sweden A 415x650 70	Pcs	Profile (mm)	Length (mm)	
	WINDOW 830x1830 W5-S70P-0XT-08301830  W122-PT Right handed - DIN rechts Tempered glass - Gehärtetes Glas Opens inside - Öffnet innen	1			
VIHM 01-1	Rain deflector - Regenabweiser		1	36x134	1030
KR-0 3524	Screws - Schrauben 3.5x45 C3 for door and window trims - für Tür- und Fensterleisten		24		
KR-0 4001	Screws - Schrauben 4.0x60 C3 for rain deflector - für Regenabweiser		3		
Kood	Sweden A 415x650 70	Materjal	File	G0265 Sweden A 415x650 70.dwg	1/10

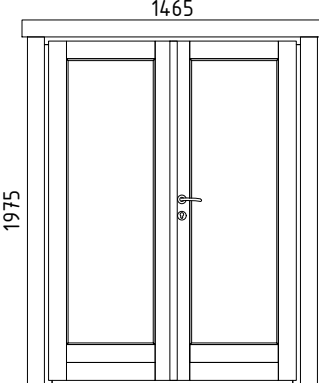
Pos	Model Sweden A 415x650 70	Pcs	Profile (mm)	Length (mm)
	WINDOW 830x1830 W5-S70V-0XT-08301830  W122-VT Left handed - DIN links Tempered glass - Gehärtetes Glas Opens inside - Öffnet innen	1		
VIHM 01-1	Rain deflector - Regenabweiser		36x134	1030
KR-0 3524	Screws - Schrauben 3.5x45 C3 for door and window trims - für Tür- und Fensterleisten		24	
KR-0 4001	Screws - Schrauben 4.0x60 C3 for rain deflector - für Regenabweiser		3	
Kood	Sweden A 415x650 70	Materjal	File	G0265 Sweden A 415x650 70.8/10

Pos	Model Sweden A 415x650 70	Pcs	Profile (mm)	Length (mm)
	DOOR 800x1980 D0-I70L-XXX-08001980  D913-LX Left handed - DIN links Opens outside - Öffnet aussen	1		
KR-0 3524	Screws - Schrauben 3.5x45 C3 for door and window trims - für Tür- und Fensterleisten	26		
Kood	Sweden A 415x650 70	Materjal	File	Leht 9/10

Pos	Model Sweden A 415x650 70	Pcs	Profile (mm)	Length (mm)
	<p>DOOR 1465x1975 D5-D70R-0XT-14651975</p>  <p>D202-RT Right handed - DIN rechts Tempered glass - Gehärtetes Glas Opens outside - Öffnet aussen</p>	1		
VIHM 01-2	Rain deflector - Regenabweiser 	1	36x134	1665
KR-0 3524	Screws - Schrauben 3.5x45 C3 for door and window trims - für Tür- und Fensterleisten 	28		
KR-0 4001	Screws - Schrauben 4.0x60 C3 for rain deflector - für Regenabweiser 	4		
Kood	Sweden A 415x650 70			
	Materjal			
	File			
			Leht	10/10

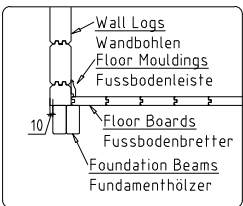
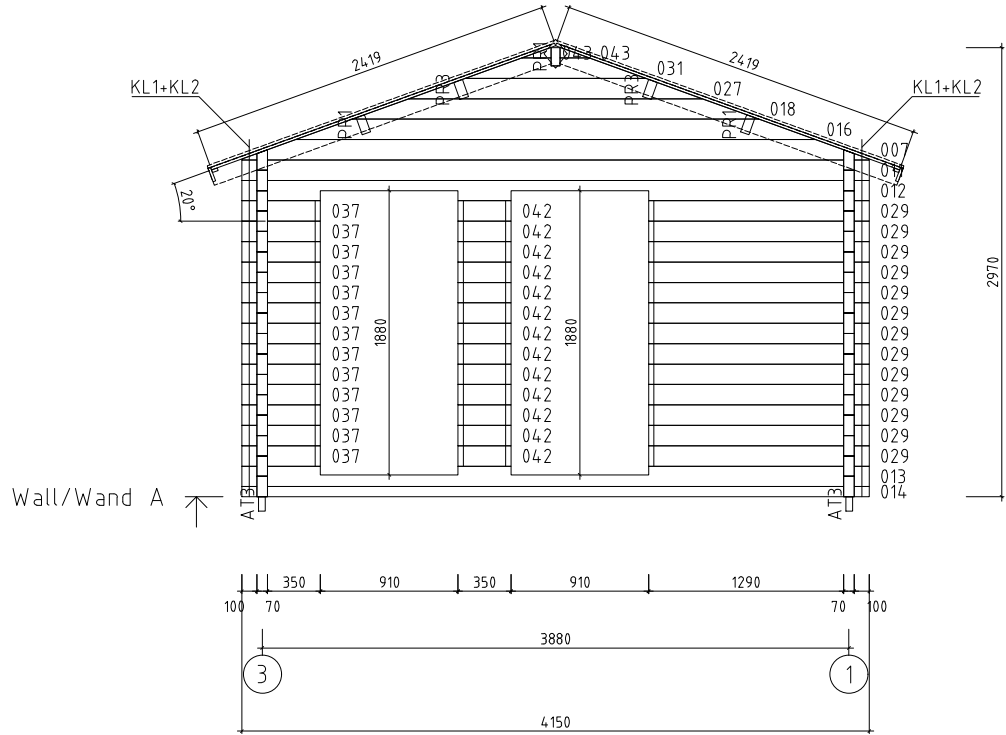
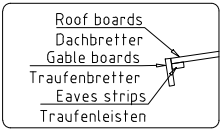

Name	Sweden A 415x650 70		SKU	G0265	
Drawing/Zeichnung	Wall/Wand A		Format	A4	
Profile/Profil	7x13.5	Scale/Maßstab	1:50	Date	09.05.2023

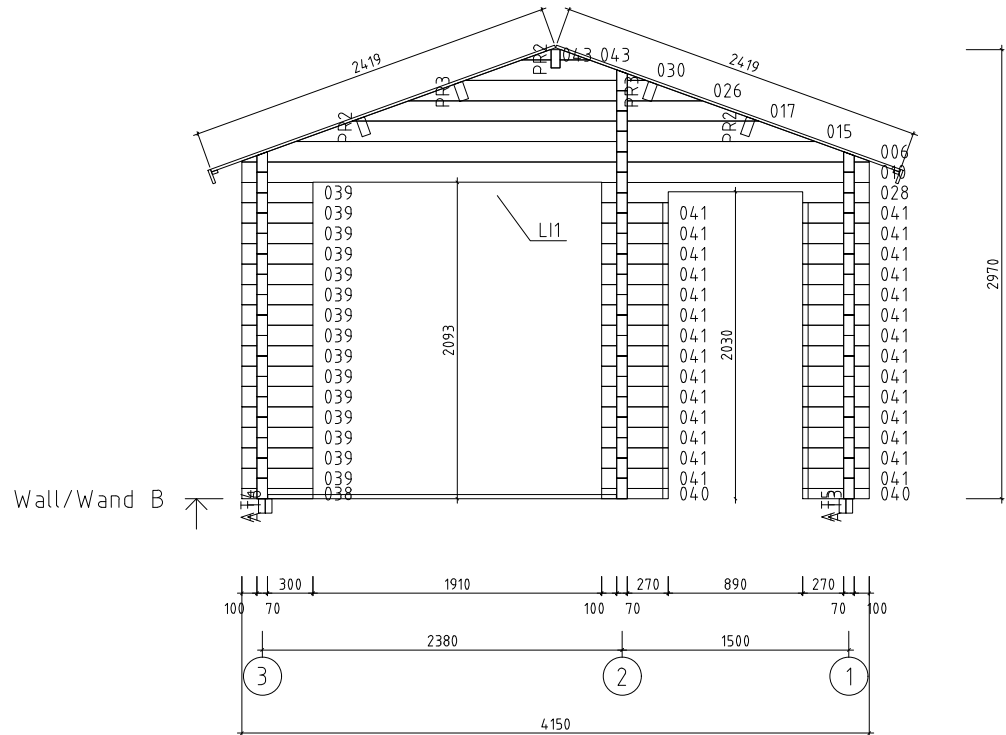

 www.hansa24.com	Name		Sweden A 415x650 70		SKU		G0265	
	Drawing/Zeichnung		Wall/Wand B			Format		A4
	Profile/Profil		7x13.5	Scale/Maßstab		1:50	Date	

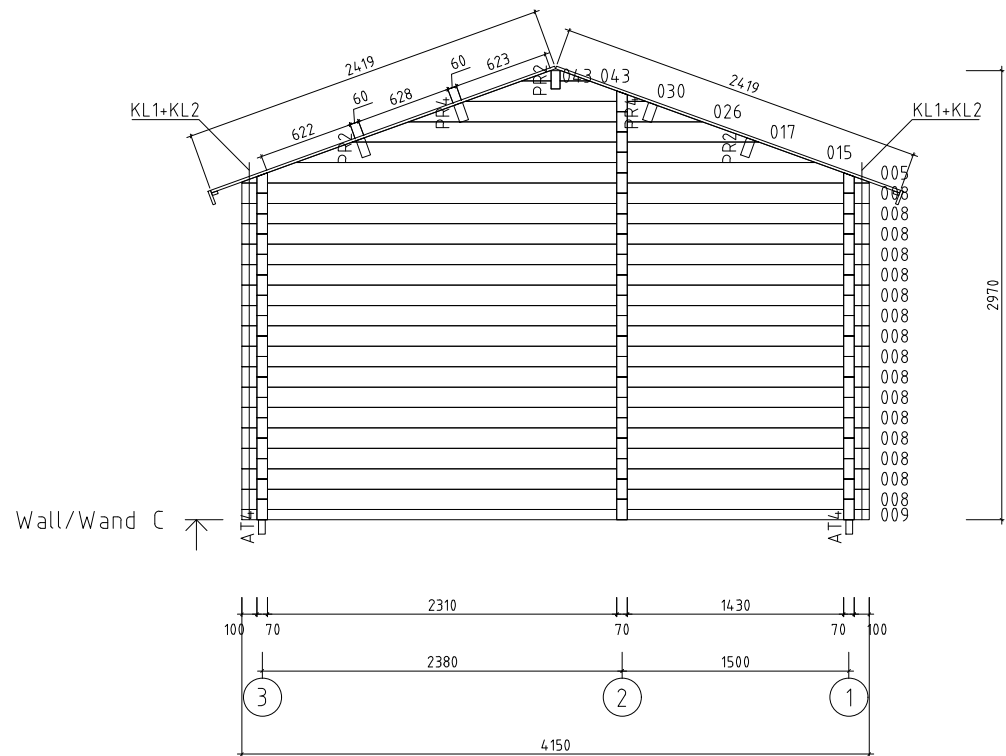

Name	Sweden A 415x650 70	SKU	G0265
Drawing/Zeichnung	Wall/Wand C	Format	A4
Profile/Profil	7x13.5	Scale/Maßstab	1:50
Date	09.05.2023		

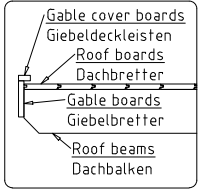

Wall/Wand 1 ↑

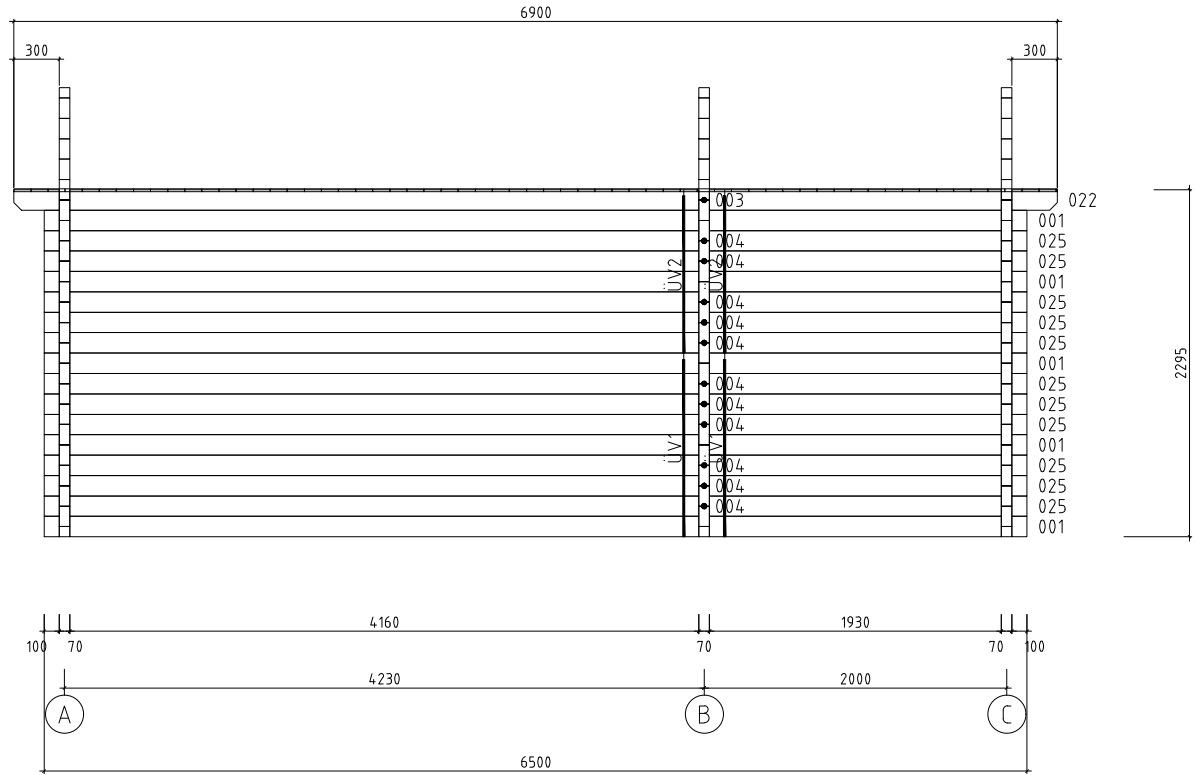

 www.hansa24.com	Name Sweden A 415x650 70		SKU G0265
	Drawing/Zeichnung Wall/Wand 1		Format A4
	Profile/Profil 7x13.5	Scale/Maßstab 1:50	Date 09.05.2023

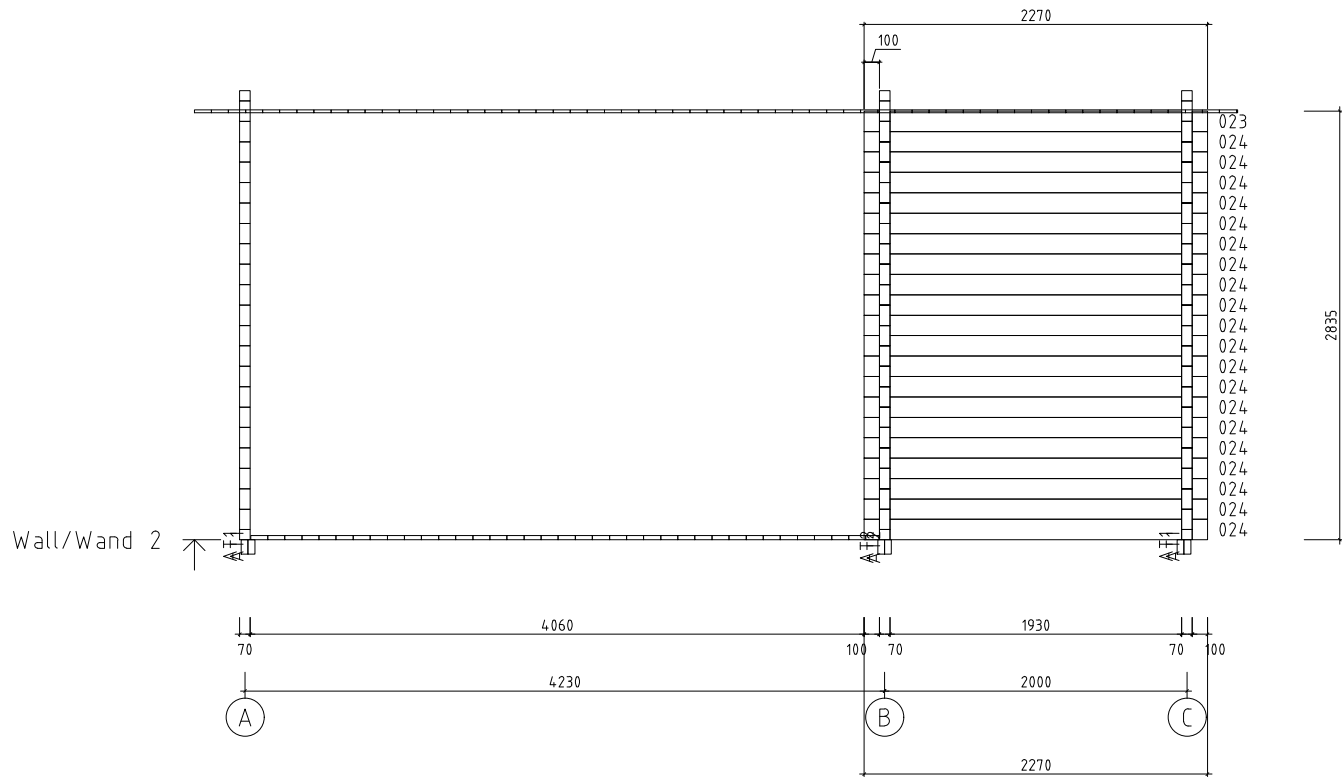

 www.hansa24.com	Name		Sweden A 415x650 70	SKU	G0265
	Drawing/Zeichnung		Wall/Wand 2	Format	A4
	Profile/Profil	7x13.5	Scale/Maßstab	1:50	Date

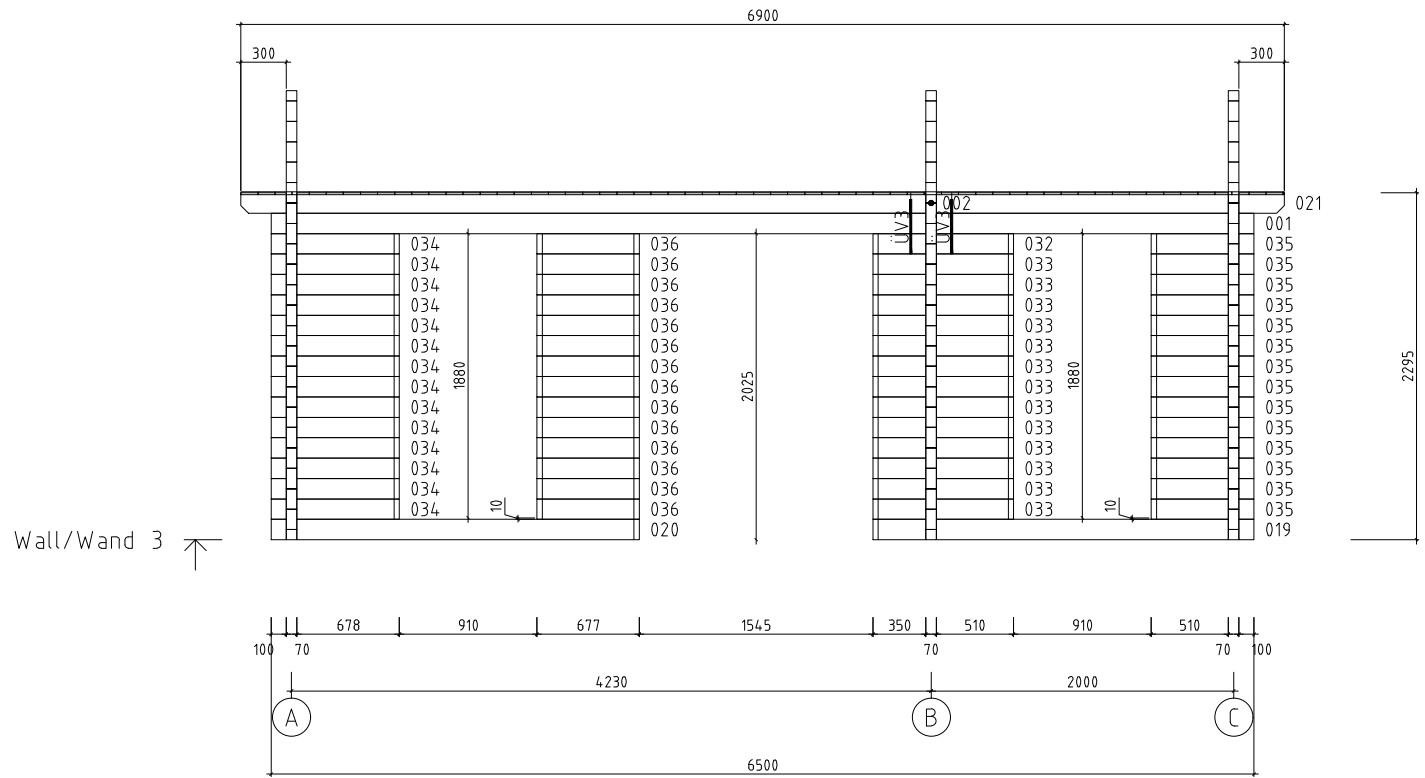

 www.hansa24.com	Name		Sweden A 415x650 70		SKU		G0265
	Drawing/Zeichnung		Wall/Wand 3		Format		A4
	Profile/Profil	7x13.5	Scale/Maßstab	1:50	Date	09.05.2023	