

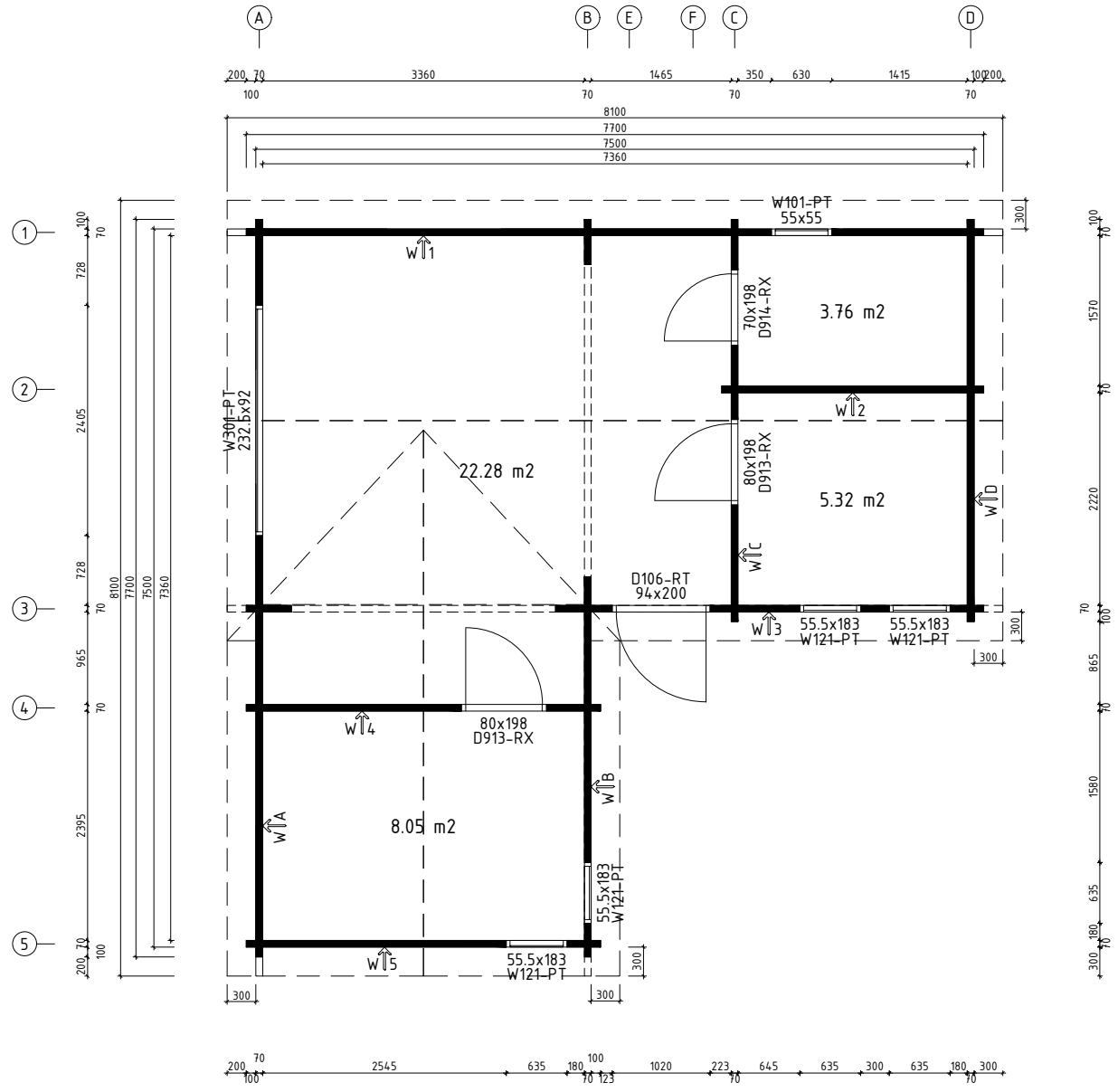

 www.hansa24.com	Name		Devon II 770x770 70	SKU	G0281
	Drawing/Zeichnung		3D	Format	A3
	Profile/Profil	7x13.5	Scale/Maßstab	Date	

H = 1.790 m  
TOTAL: 39.41 m<sup>2</sup>





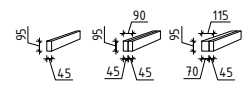
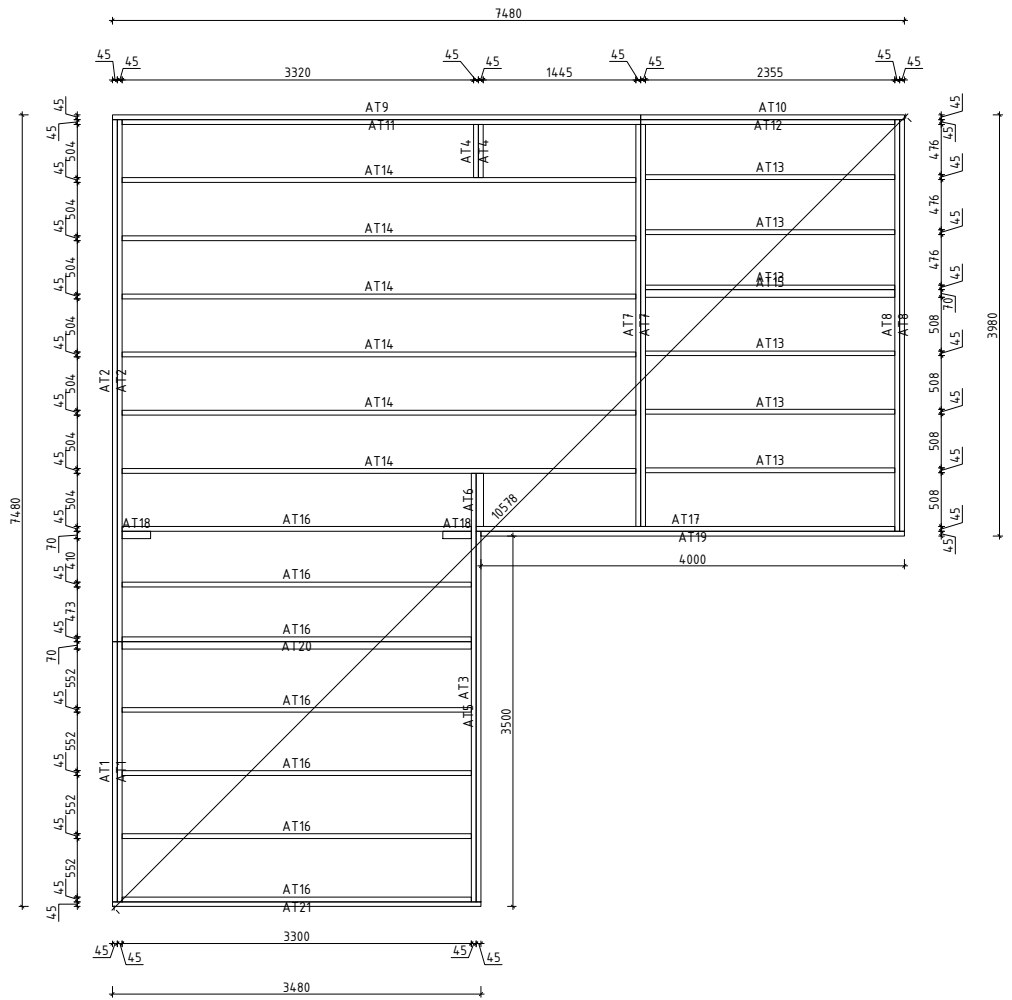





	Name		Devon II 770x770 70		SKU	G0281
	Drawing/Zeichnung		Plan_Grundplan		Format	A3
	Profile/Profil	7x13.5	Scale/Maßstab	1:50	Date	26.01.2023

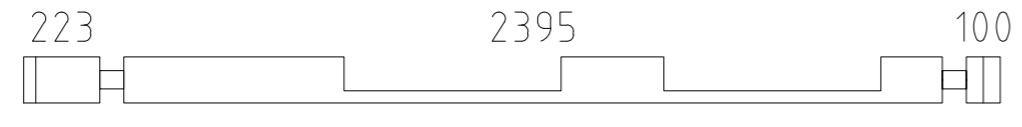
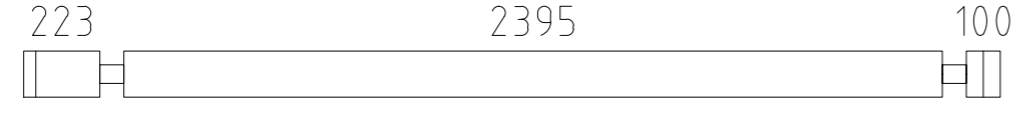
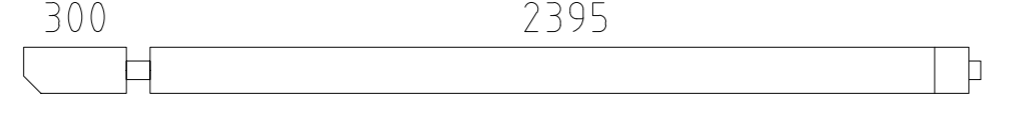
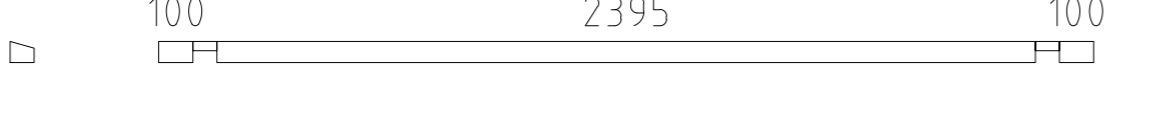
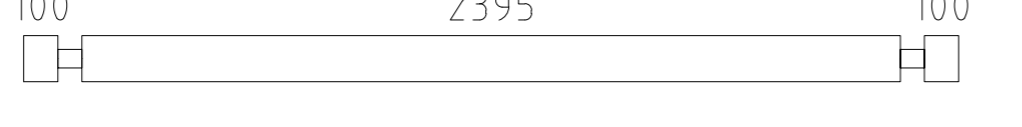
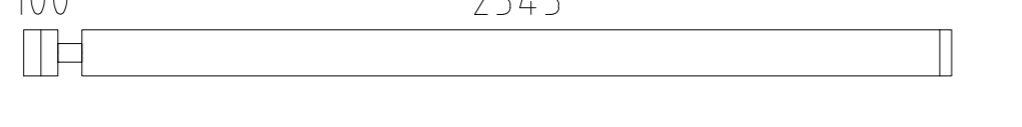
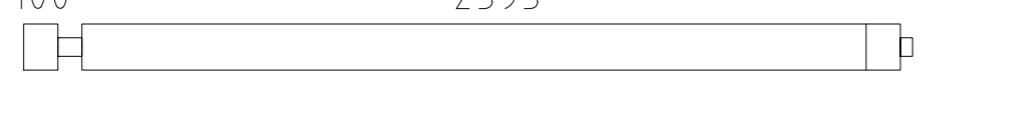
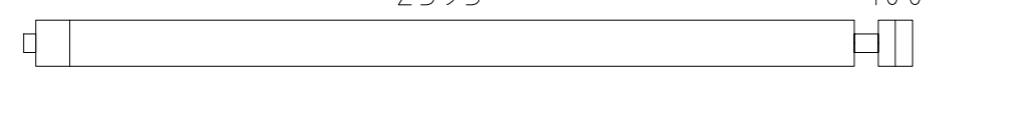
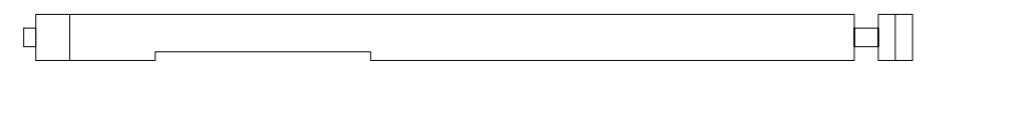
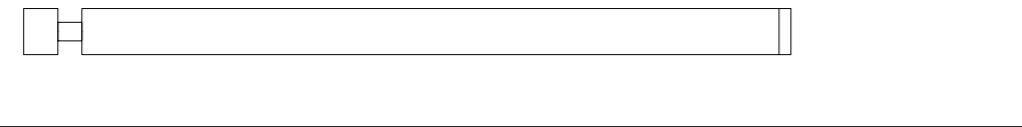
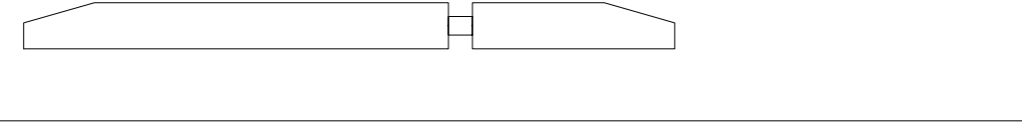
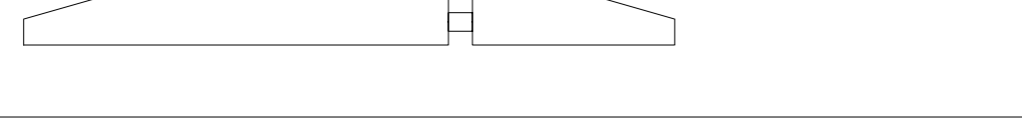
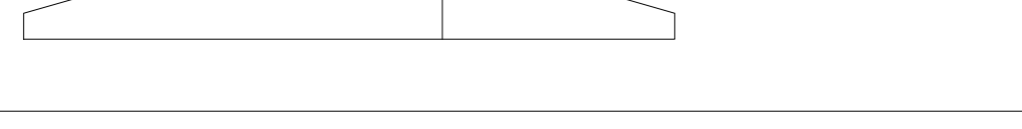
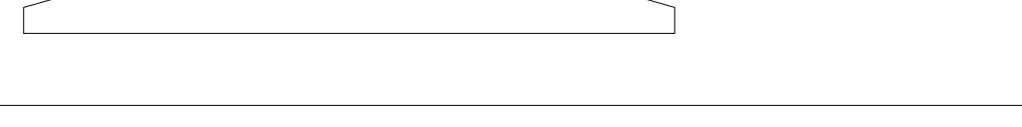
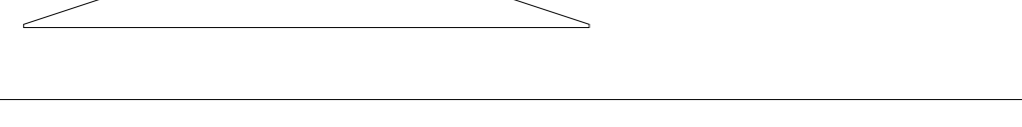
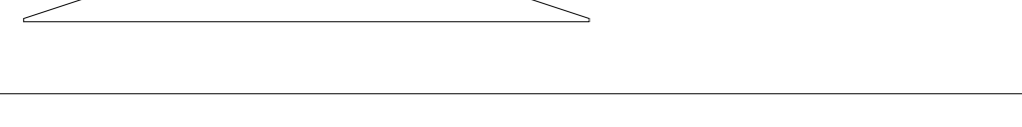

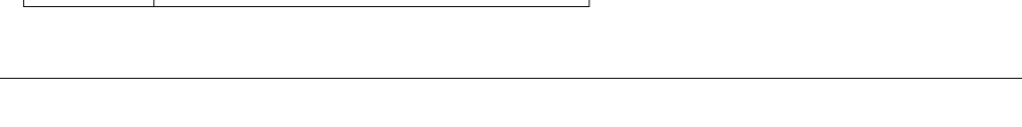







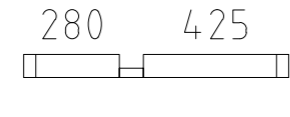
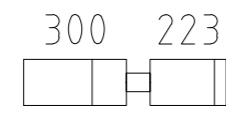
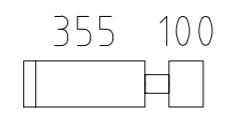
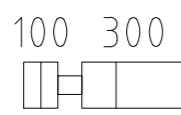
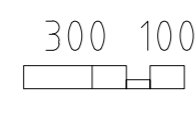
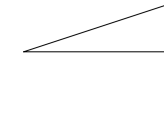
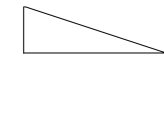
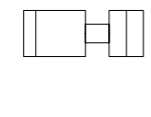





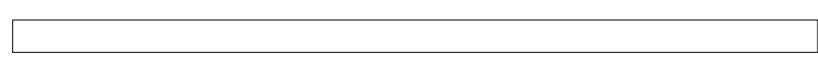
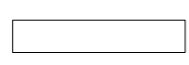
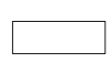

 www.hansa24.com	Name		Devon II 770x770 70		SKU	G0281
	Drawing/Zeichnung		Foundation plan_Lagerholzplan		Format	A3
	Profile/Profil	7x13.5	Scale/Maßstab	1:50	Date	26.01.2023

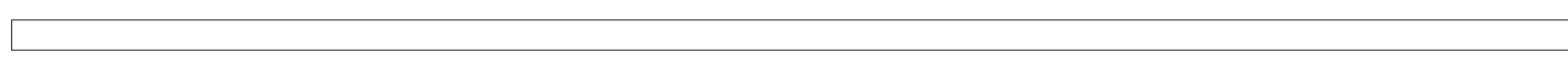
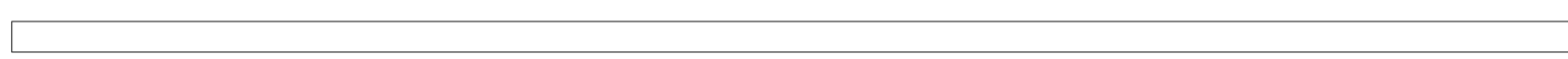
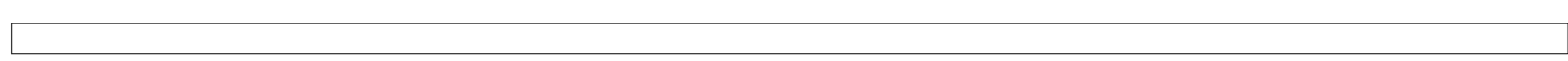
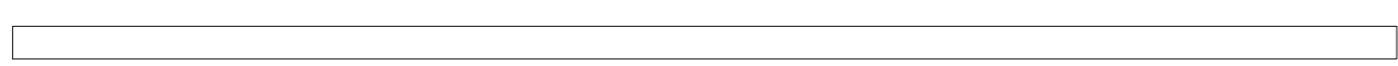
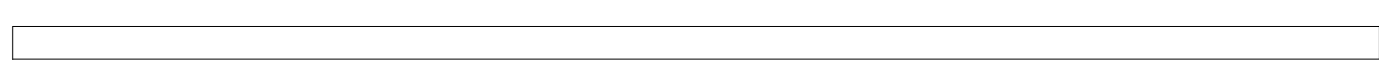
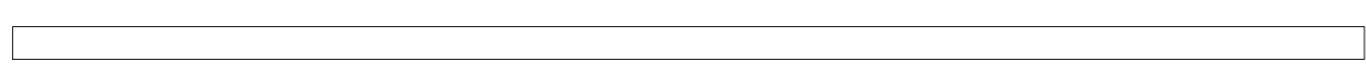
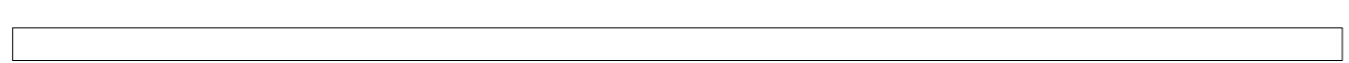
Pos	Model Devon II 770x770 70	Pcs	Profile (mm)	Length (mm)
	Notice! The gable pieces can be partly pre-assembled! Please notice - those differ from the description given in the specification list.			
	Achtung! Die Giebelbohlen können teilweise schon vormontiert sein! Bitte beachten - diese erscheinen nicht ganz so wie in der Teilleiste beschrieben.			
001	100 3360 spare log/Ersatzteile 1465 350 	1	70x135	5485
001	100 3360 1465 350 	4	70x135	5485
002	100 3360 1465 	6	70x135	5100
003	965 3860 100 	1	70x135	5100
004	965 3860 100 	5	70x135	5100
005	300 1465 2395 100 	1	70x135	4470
006	100 2395 965 728 	1	70x135	4398
007	100 2395 965 728 	4	70x135	4398
008	100 2395 965 728 	1	70x135	4398
009	1465 2395 300 	1	70x135	4335
010	1465 2395 300 	1	70x135	4335
011	100 2220 1570 100 	1	70x135	4200
012	100 2220 1570 100 	1	70x135	4200
013	100 2220 1570 100 	17	70x135	4200
014	100 2220 1570 100 	1	70x68	4200
015	100 2220 1570 100 	1	70x135	4200
016	1465 2395 100 	5	70x135	4135
017	1465 2395 100 	1	70x135	4135
018	3860 100 	1	70x135	4065
019	3860 100 	1	70x135	4065
020	3860 100 	1	70x68	4065
021	3860 100 	3	70x135	4065
022	3860 100 	1	70x135	4065
023	3860 100 	1	70x135	4065
024	100 2395 965 300 	1	70x68	3970
025	100 2395 965 300 	1	70x135	3970
Kood	Devon II 770x770 70	Materjal	File	Leht 1/15





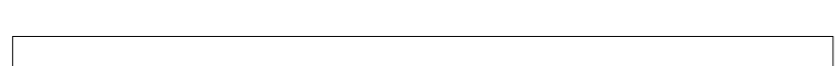



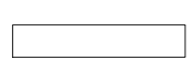

Pos	Model Devon II 770x770 70	Pcs	Profile (mm)	Length (mm)
026		1	70x135	3970
027		1	70x68	3835
028		1	70x68	3835
029		1	70x135	3765
030		1	70x135	3765
031		1	70x135	3700
032		1	70x135	3700
033		1	70x135	3700
034		1	70x135	3700
035		1	70x135	3700
036		1	70x135	3700
037		1	70x68	3635
038		5	70x135	3635
039		6	70x135	3565
040		1	70x135	3386
041		1	70x135	3386
042		1	70x135	3386
043		1	70x135	3386
044		1	70x135	3360
045		1	70x135	3360
046		1	70x135	3360
047		1	70x135	2985
048		5	70x135	2985
049		1	70x135	2985
050		6	70x135	2985
Kood	Devon II 770x770 70	Materjal	File	Leht 2/15

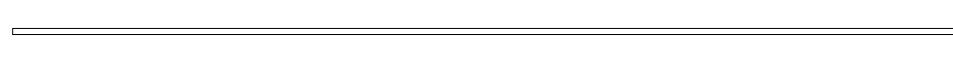
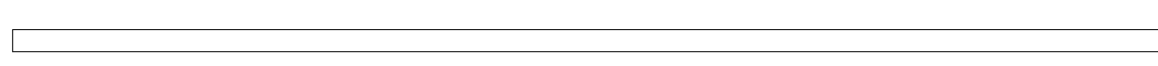
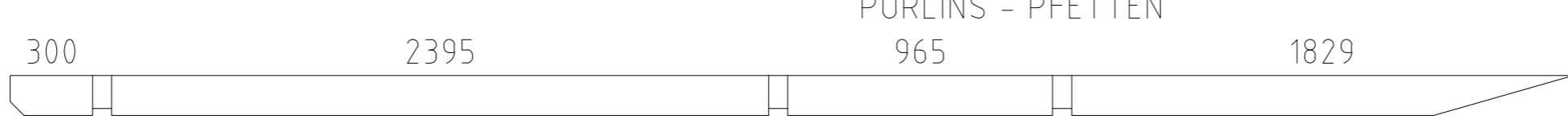
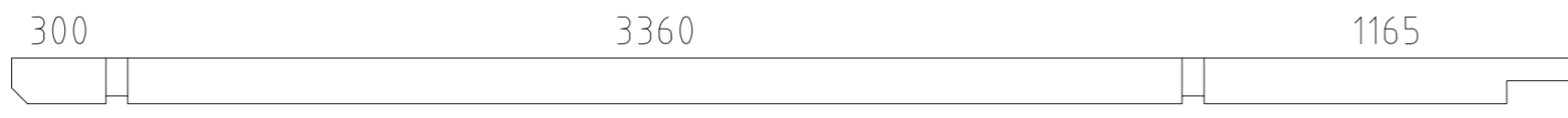
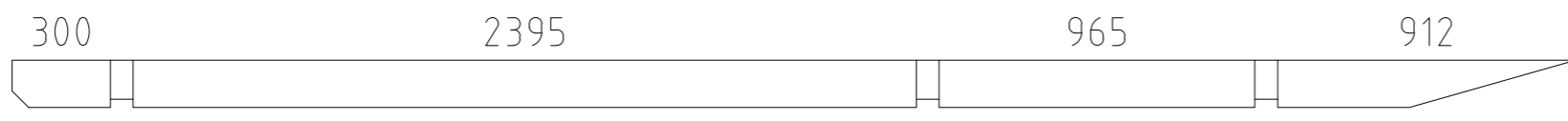
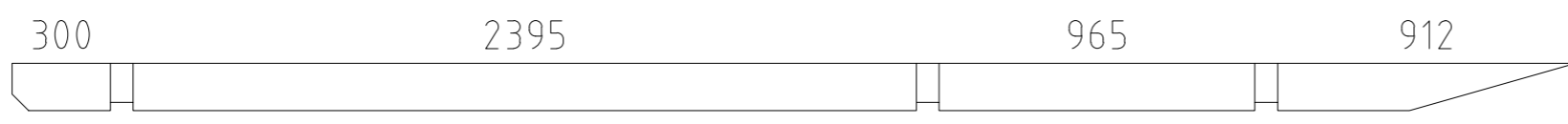
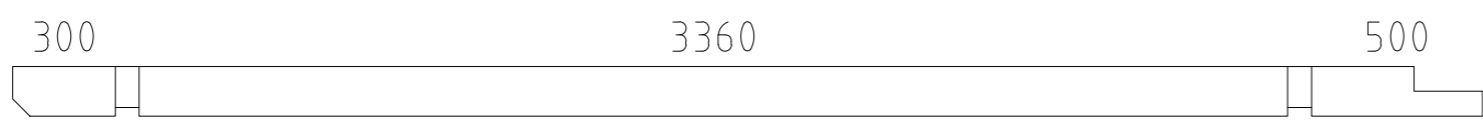
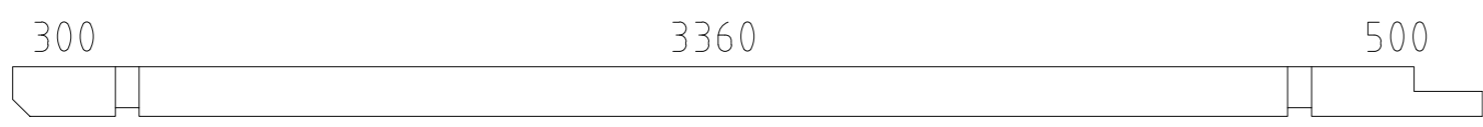
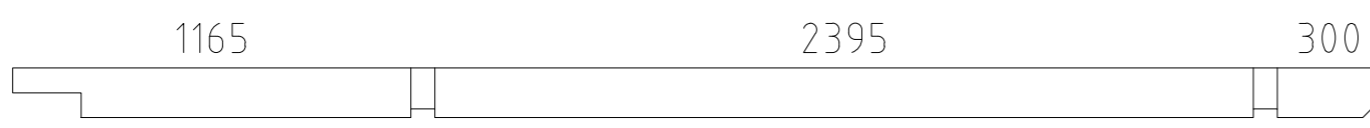
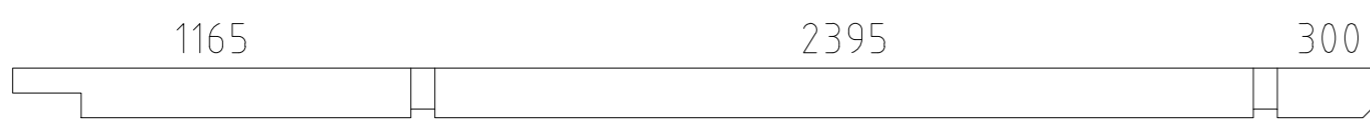
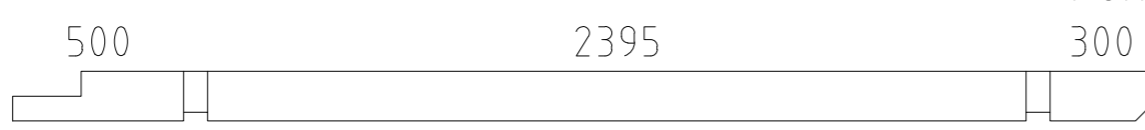
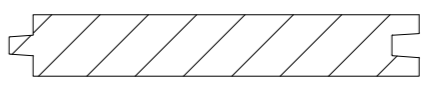
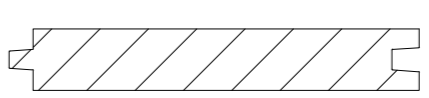





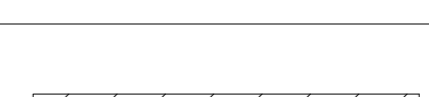

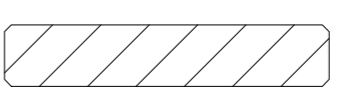

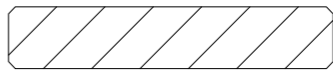
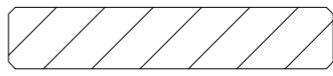
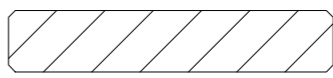
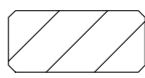
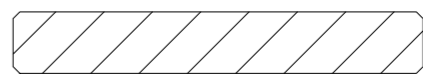
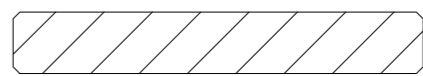
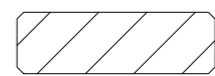
Pos	Model Devon II 770x770 70	Pcs	Profile (mm)	Length (mm)
051		1	70x135	2858
052		1	70x135	2858
053		2	70x135	2800
054		1	70x62	2735
055		20	70x135	2735
056		13	70x135	2715
057		4	70x135	2600
058		5	70x135	2600
059		1	70x135	2600
060		15	70x135	2245
061		1	70x135	1905
062		1	70x135	1905
063		1	70x135	1905
064		1	70x135	1905
065		1	70x135	1655
066		1	70x135	1655
067		2	70x135	1655
068		1	70x135	1655
069		1	70x135	1655
070		4	70x135	1585
071		1	70x135	1491
072		1	70x135	1491
073		1	70x135	1491
074		1	70x135	1491
075		1	70x68	1220
Kood	Devon II 770x770 70	Materjal	File	Leht 3/15

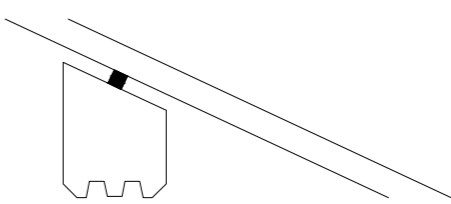
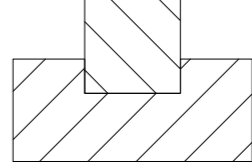
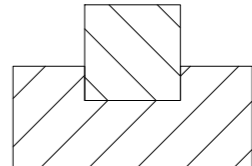
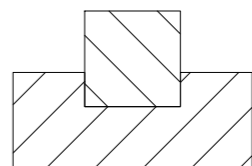
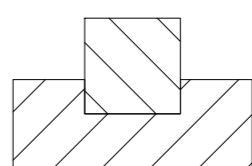
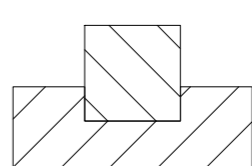

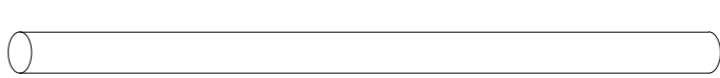
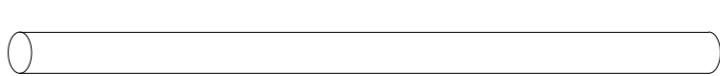



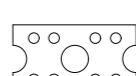
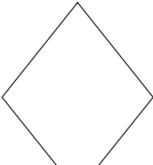
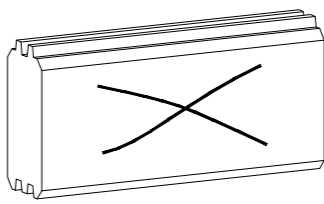







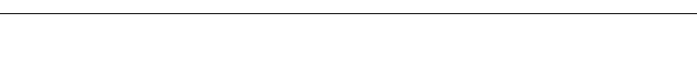

Pos	Model Devon II 770x770 70	Pcs	Profile (mm)	Length (mm)
076		14	70x135	1220
077		13	70x135	938
078		6	70x135	898
079		1	70x68	775
080		14	70x135	775
081		1	70x135	593
082		5	70x135	593
083		1	70x135	593
084		8	70x135	593
085		15	70x135	565
086		1	70x68	525
087		14	70x135	525
088		8	70x135	470
089		1	70x135	470
090		7	70x135	470
091		1	70x68	470
092		7	70x135	470
093		1	70x135	470
094		7	70x135	470
095		2	70x135	416
096		4	70x135	416
097		2	70x125	381
098		4	70x125	381
099		26	70x135	350
100		13	70x135	350

Pos	Model Devon II 770x770 70	Pcs	Profile (mm)	Length (mm)
101		13	70x135	300
102		5	70x68	242
103		3	70x68	242
104		5	70x59	207
105		3	70x59	207
AT20	FOUNDATION BEAMS (impregnated) - FUNDAMENTHÖLZER (imprägniert) 	1	70x95	3300
AT15	FOUNDATION BEAMS (impregnated) - FUNDAMENTHÖLZER (imprägniert) 	1	70x95	2355
AT6	FOUNDATION BEAMS (impregnated) - FUNDAMENTHÖLZER (imprägniert) 	1	70x95	504
AT18	FOUNDATION BEAMS (impregnated) - FUNDAMENTHÖLZER (imprägniert) 	2	70x95	270
AT9	FOUNDATION BEAMS (impregnated) - FUNDAMENTHÖLZER (imprägniert) 	1	45x95	4990
AT2	FOUNDATION BEAMS (impregnated) - FUNDAMENTHÖLZER (imprägniert) 	2	45x95	4932
AT11	FOUNDATION BEAMS (impregnated) - FUNDAMENTHÖLZER (imprägniert) 	1	45x95	4900
AT14	FOUNDATION BEAMS (impregnated) - FUNDAMENTHÖLZER (imprägniert) 	6	45x95	4855
AT3	FOUNDATION BEAMS (impregnated) - FUNDAMENTHÖLZER (imprägniert) 	1	45x95	4049
AT19	FOUNDATION BEAMS (impregnated) - FUNDAMENTHÖLZER (imprägniert) 	1	45x95	4000
AT17	FOUNDATION BEAMS (impregnated) - FUNDAMENTHÖLZER (imprägniert) 	1	45x95	3955
AT8	FOUNDATION BEAMS (impregnated) - FUNDAMENTHÖLZER (imprägniert) 	2	45x95	3890
AT7	FOUNDATION BEAMS (impregnated) - FUNDAMENTHÖLZER (imprägniert) 	2	45x95	3800
AT5	FOUNDATION BEAMS (impregnated) - FUNDAMENTHÖLZER (imprägniert) 	1	45x95	3500
AT21	FOUNDATION BEAMS (impregnated) - FUNDAMENTHÖLZER (imprägniert) 	1	45x95	3480
AT16	FOUNDATION BEAMS (impregnated) - FUNDAMENTHÖLZER (imprägniert) 	7	45x95	3300
AT10	FOUNDATION BEAMS (impregnated) - FUNDAMENTHÖLZER (imprägniert) 	1	45x95	2490
AT1	FOUNDATION BEAMS (impregnated) - FUNDAMENTHÖLZER (imprägniert) 	2	45x95	2458
AT12	FOUNDATION BEAMS (impregnated) - FUNDAMENTHÖLZER (imprägniert) 	1	45x95	2400
AT13	FOUNDATION BEAMS (impregnated) - FUNDAMENTHÖLZER (imprägniert) 	6	45x95	2355
Kood	Devon II 770x770 70	Materjal	File	Leht 5/15





Pos	Model Devon II 770x770 70	Pcs	Profile (mm)	Length (mm)
AT4	FOUNDATION BEAMS (impregnated) - FUNDAMENTHÖLZER (imprägniert) 	2	45x95	504
LI2	SLAT - LEISTE (Für Kehle/ for valley) 	2	58x18	3400
LI1	SLAT - LEISTE 	1	58x18	3260
LI3	SLAT - LEISTE 	1	58x18	2760
KLI1	CARRIER SLAT - TRÄGELEISTE 	1	44x65	3360
PR2	PURLINS - PFETTEN 	1	70x145	5699
PR6	PURLINS - PFETTEN 	1	70x145	4965
PR3	PURLINS - PFETTEN 	1	70x145	4782
PR1	PURLINS - PFETTEN 	1	70x145	4782
PR8	PURLINS - PFETTEN 	1	70x145	4300
PR4	PURLINS - PFETTEN 	1	70x145	4300
PR5	PURLINS - PFETTEN 	1	70x145	4000
PR9	PURLINS - PFETTEN 	1	70x145	4000
PR7	PURLINS - PFETTEN 	1	70x145	3335
	ROOF BOARDS - DACHBRETTER 	114+3	113x18	2392
	ROOF BOARDS - DACHBRETTER 	102	113x18	2158
	ROOF BOARDS - DACHBRETTER 	30	113x18	1996
	FLOOR BOARDS - FUSSBODENBRETTER 	30+2	113x28	4890
	FLOOR BOARDS - FUSSBODENBRETTER 	14	113x28	3855
	FLOOR BOARDS - FUSSBODENBRETTER 	30	113x28	2390
	FLOOR BOARDS - FUSSBODENBRETTER 	22	113x28	2215
	FLOOR BOARDS - FUSSBODENBRETTER 	22	113x28	1565
	Ceiling mouldings - Deckenleisten (inside and outside - innen und außen) 		15x28	114 rm/lfm
	Floor mouldings - Fussbodenleisten 		14x55	51 rm/lfm
RLA 01-1	Eave board - Traufenbrett 18x95 	1	18x95	300
Kood	Devon II 770x770 70	Materjal	File	Leht 6/15



Pos	Model Devon II 770x770 70		Pcs	Profile (mm)	Length (mm)
RLA 01-2	Eave board - Traufenbrett 18x95		2	18x95	4050
RLA 01-3	Eave board - Traufenbrett 18x95		1	18x95	4300
RLA 01-4	Eave board - Traufenbrett 18x95		2	18x95	5699
RLI01-1	Eave slat - Traufenleiste 18x40			18x40	26.6 m/lfm
VLA 02-1	Gable board - Giebelbrett 18x120	18.2° 	2	18x120	2258
VLA 02-2	Gable board - Giebelbrett 18x120	15.9° 	4	18x120	2492
VKL 02-1	Gable cover slat - Giebeldeckleiste 18x58		2	18x58	2258
VKL 02-2	Gable cover slat - Giebeldeckleiste 18x58		4	18x58	2492
TH01-1	Seal tape (upper log on sidewalls) - Dichtungsband (letzte bohlenkranz seitenwänder)				21.5 m/lfm
	T-strip - T-Leiste 70		2		480
	T-strip - T-Leiste 70		2		750
	T-strip - T-Leiste 70		8		1695
	T-strip - T-Leiste 70		4		1898
	T-strip - T-Leiste 70		4		1965
ÜV1	Metal bar - Metallstange Ø10		10	Ø10	1170
ÜV2	Metal bar - Metallstange Ø10		4	Ø10	1100
ÜV3	Metal bar - Metallstange Ø10		4	Ø10	1040
ÜV4	Metal bar - Metallstange Ø10		2	Ø10	700
ÜV5	Metal bar - Metallstange Ø10		4	Ø10	500
ÜV6	Metal bar - Metallstange Ø10		6	Ø10	430
ÜV7	Metal bar - Metallstange Ø10		1	Ø10	360
ML01	Connecting strip for wall logs - Verbindungsstreifen für Wandbalken		28		
GD01	Diamond - Diamant		3		
LK	Hit block - Schlaghölzer		3		
N-0 2503	Nails - Nägel 2.5x60 for floor boards - für Fussbodenbretter		1576		
Kood	Devon II 770x770 70	Materjal	File	Leht	7/15

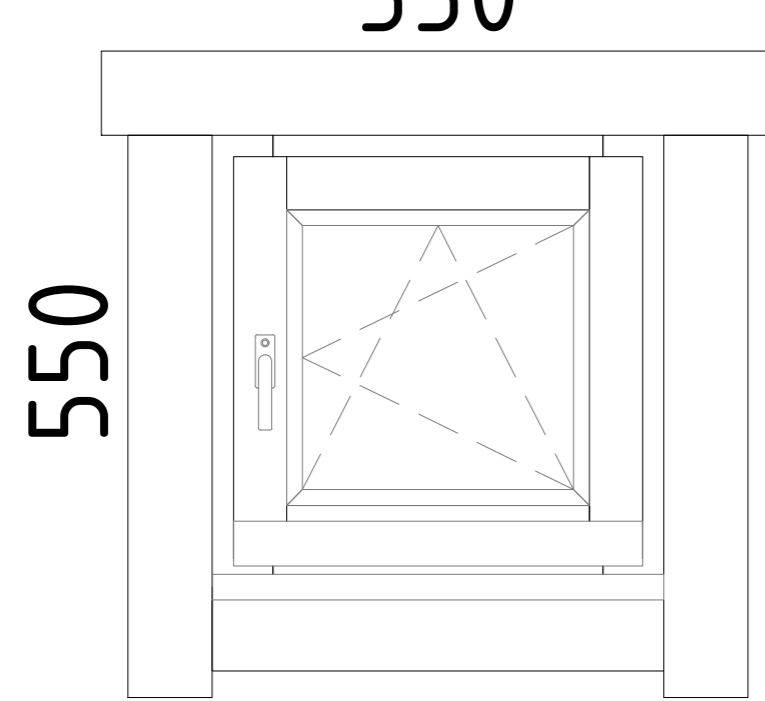
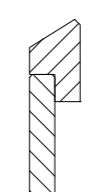

Pos	Model Devon II 770x770 70		Pcs	Profile (mm)	Length (mm)
N-0 2501	Nails - Nägel vierkant 2.5x50 for ceiling boards - für Dachbretter		1476		
KR-0 3001	Screws - Schrauben 3.0x30 for ceiling mouldings - für Deckenleisten		228		
KR-0 3002	Screws - Schrauben 3.0x30 for eave slats - für Traufenleisten		72		
KR-0 3003	Screws - Schrauben 3.0x30 for floor mouldings - für Fussbodenleisten		116		
KR-0 3522	Screws - Schrauben 3.5x45 C3 for connecting strip for wall logs - für Verbindungsstreifen für Wandbalken		112		
KR-0 3523	Screws - Schrauben 3.5x45 C3 for diamonds - für Diamanten		6		
KR-0 3525	Screws - Schrauben 3.5x45 C3 for eave boards - für Traufenbretter		72		
KR-0 3527	Screws - Schrauben 3.5x45 C3 for gable boards - für Giebelbretter		36		
KR-0 3521	Screws - Schrauben 3.5x45 C3 for gable cover slats - für Giebeldeckleisten		36		
KR-0 3530	Screws - Schrauben 3.5x45 C3 for slat - für leiste		32		
KR-0 5080	Screws - Schrauben 5.0x100 for foundation beams - für Fundamenthölzer		172		
KR-0 5035	Screws - Schrauben 5.0x70 C3 for carrier slat - für trägeleiste		8		
KL1	Threaded rod - Gewindestange M8		6		2000
KL2	Threaded rod - Gewindestange M8		1		705
KL3	Threaded rod - Gewindestange M8		1		570
KL4	Threaded rod - Gewindestange M8		2		460
KL5	Threaded rod - Gewindestange M8		4		325
KL03-1	Threaded rod for purlins - Gewindestange für die Pfetten M12		6		150
M03	Nut for purlins - Mutter für die Pfetten M12		12		
SE32	Washer for purlins - Scheibe für die Pfetten M12x37		12		
	Nut - Mutter M8		8		
	Washer - Scheibe M8x24		8		
	Extended nut - Langmutter M8		6		
	Drive-in nut - Einschlagmutter M8		8		
Kood	Devon II 770x770 70	Materjal	File	Leht	8/15

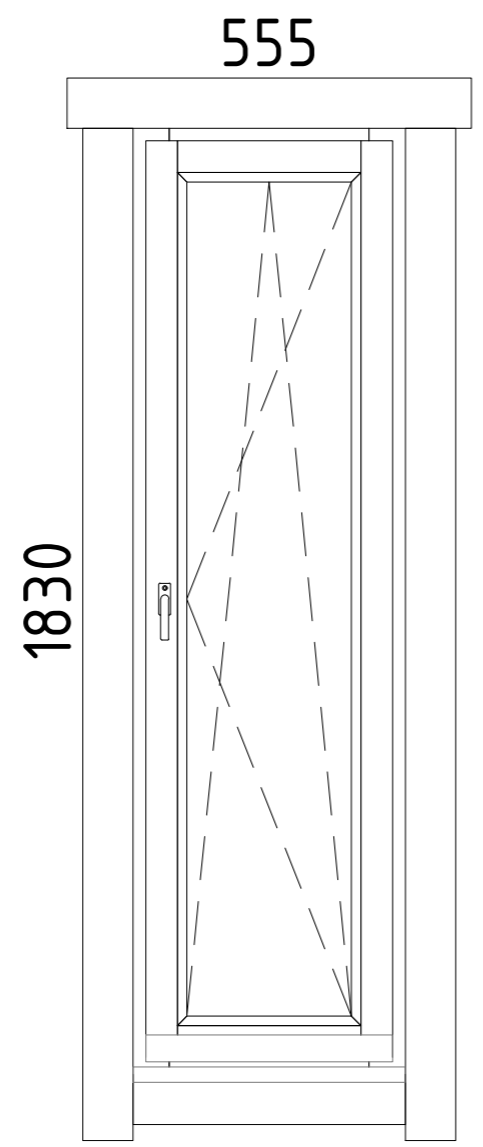
Pos	Model Devon II 770x770 70	Pcs	Profile (mm)	Length (mm)

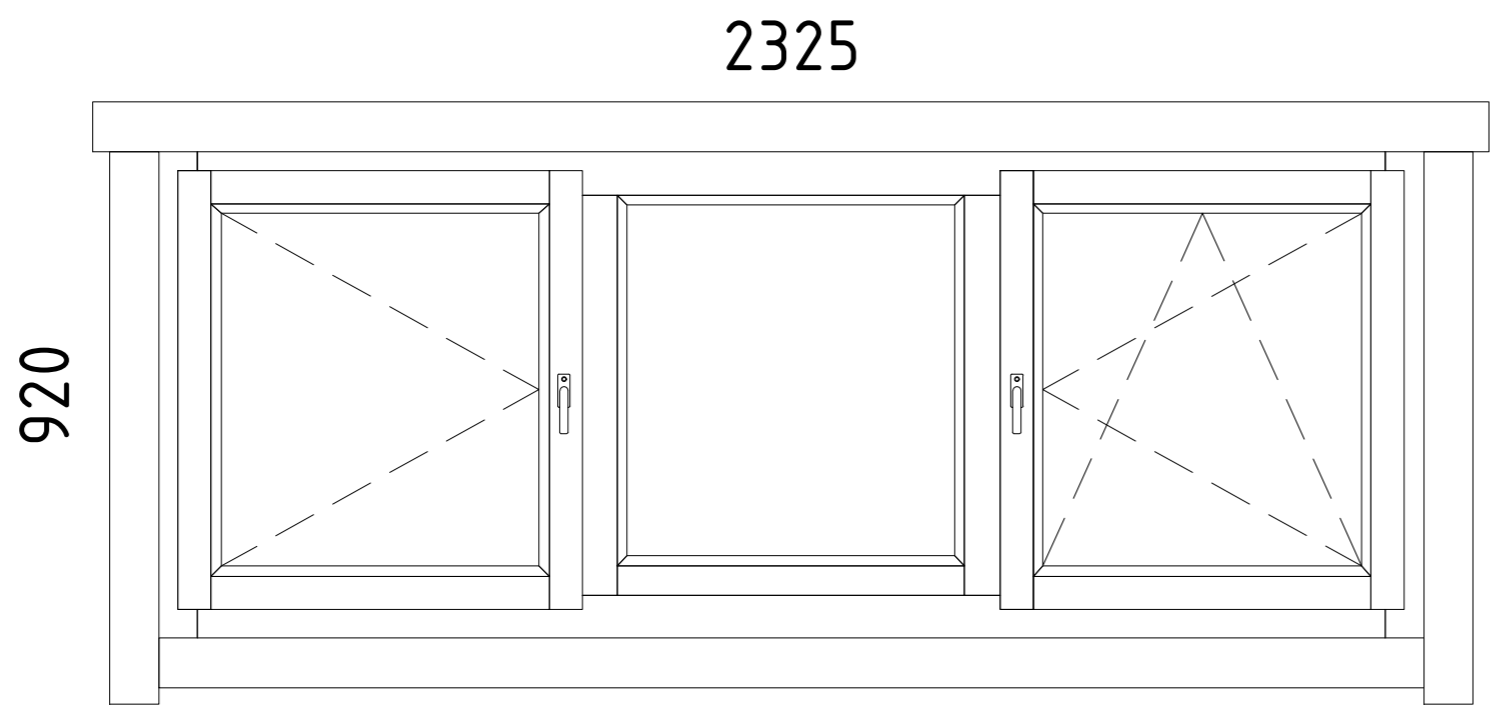
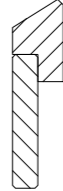
Pos	Model Devon II 770x770 70	Pcs	Profile (mm)	Length (mm)	
	<p>WINDOW 550x550 W5-S70P-0XT-05500550</p> <p>550</p>  <p>550</p> <p><b>W101-PT</b></p> <p>Right handed - DIN rechts Tempered glass - Gehärtetes Glas Opens inside - Öffnet innen</p>	1			
VIHM 01-1	Rain deflector - Regenabweiser		1	36x134	750
KR-0 3524	Screws - Schrauben 3.5x45 C3 for door and window trims - für Tür- und Fensterleisten		20		
KR-0 4001	Screws - Schrauben 4.0x60 C3 for rain deflector - für Regenabweiser		3		
Kood	Devon II 770x770 70	Materjal	File	Leht	10/15

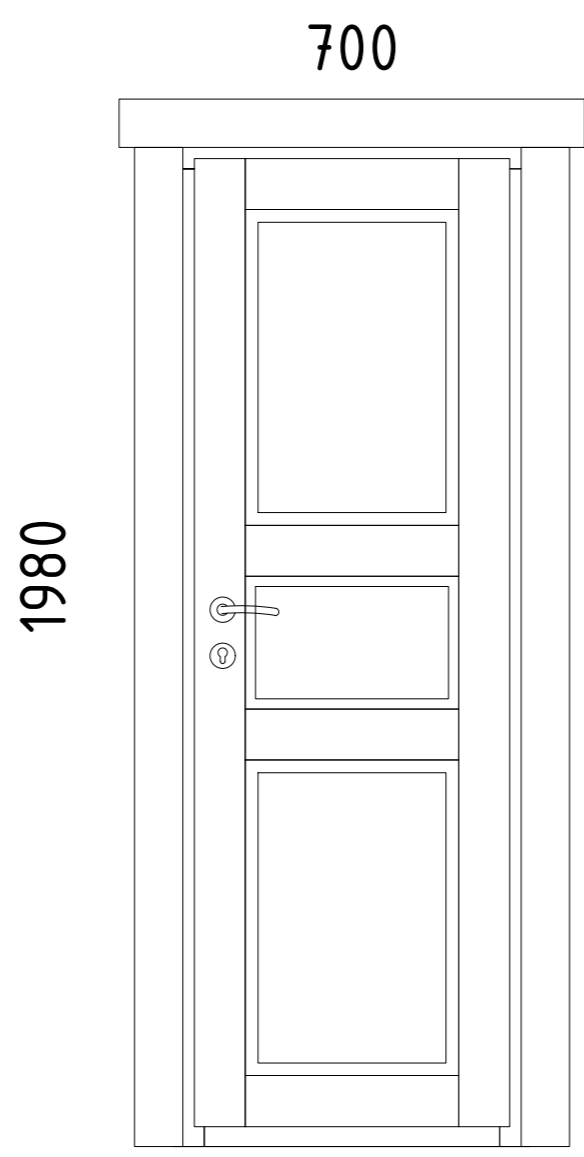

Pos	Model Devon II 770x770 70	Pcs	Profile (mm)	Length (mm)
	<p>WINDOW 555x1830 W5-S70P-0XT-05551830</p>  <p><u>W121-PT</u> Right handed - DIN rechts Tempered glass - Gehärtetes Glas Opens inside - Öffnet innen</p>	4		
VIHM 01-2	Rain deflector - Regenabweiser	4	36x134	755
KR-0 3524	Screws - Schrauben 3.5x45 C3 for door and window trims - für Tür- und Fensterleisten	96		
KR-0 4001	Screws - Schrauben 4.0x60 C3 for rain deflector - für Regenabweiser	8		
Kood	Devon II 770x770 70	Materjal	File	Leht 11/15

Pos	Model Devon II 770x770 70	Pcs	Profile (mm)	Length (mm)	
	<p data-bbox="800 151 1213 231">WINDOW 2325x920 W5-T70P-0XT-23250920</p>  <p data-bbox="1100 329 1255 371"><u>W301-PT</u></p> <p data-bbox="1100 406 1654 543">Right handed - DIN rechts Tempered glass - Gehärtetes Glas Opens inside - Öffnet innen</p>	1			
VIHM 01-3	Rain deflector - Regenabweiser		1	36x134	2525
KR-0 3524	Screws - Schrauben 3.5x45 C3 for door and window trims - für Tür- und Fensterleisten		36		
KR-0 4001	Screws - Schrauben 4.0x60 C3 for rain deflector - für Regenabweiser		6		
Kood	Devon II 770x770 70	Materjal	File	Leht	12/15

Pos	Model Devon II 770x770 70	Pcs	Profile (mm)	Length (mm)
	DOOR 700x1980 D0-I70R-XXX-07001980   700 1980 <u>D914-RX</u> Right handed - DIN rechts Opens outside - Öffnet aussen	1		
KR-0 3524	Screws - Schrauben 3.5x45 C3 for door and window trims - für Tür- und Fensterleisten 	26		
Kood Devon II 770x770 70	Materjal	File	Leht 13/15	

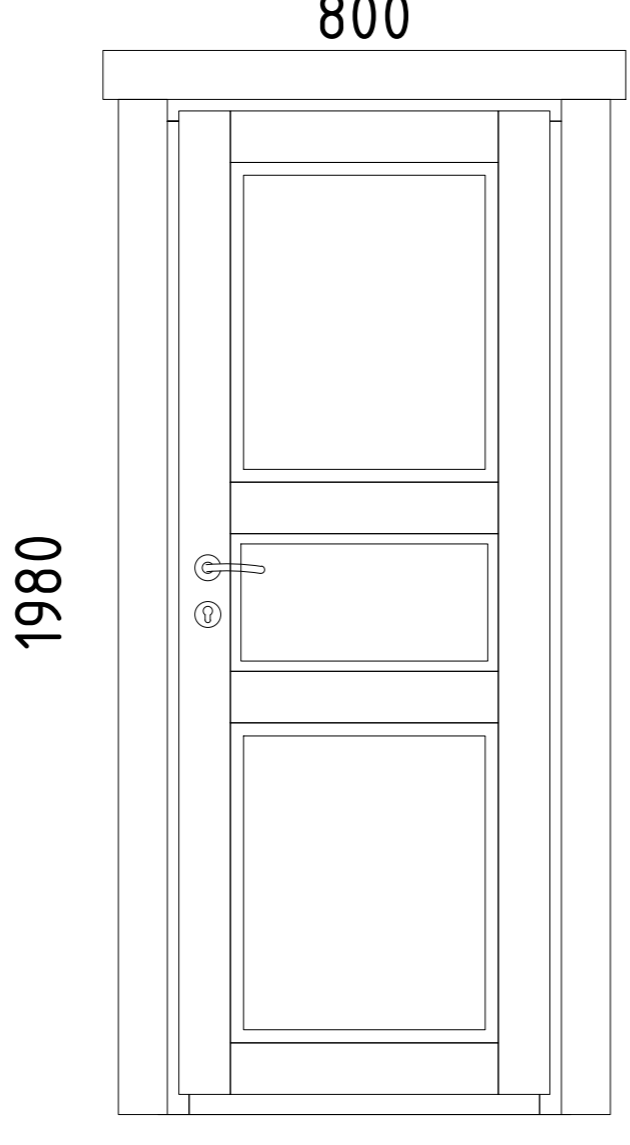

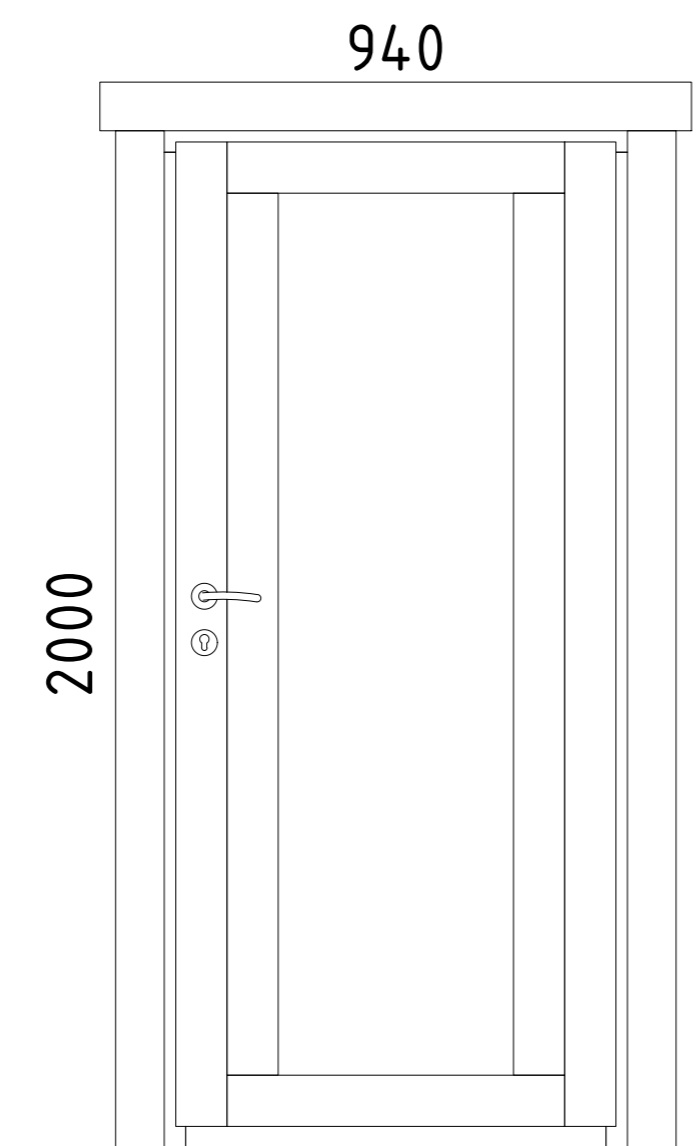
Pos	Model Devon II 770x770 70	Pcs	Profile (mm)	Length (mm)
	<p style="text-align: center;">DOOR 800x1980 D0-I70R-XXX-08001980</p> <div style="display: flex; align-items: center;"> <div style="margin-right: 20px;">  </div> <div> <p><b>D913-RX</b></p> <p>Right handed - DIN rechts Opens outside - Öffnet aussen</p> </div> </div>	2		
KR-0 3524	Screws - Schrauben 3.5x45 C3 for door and window trims - für Tür- und Fensterleisten	52		

Pos	Model Devon II 770x770 70	Pcs	Profile (mm)	Length (mm)
	<p style="text-align: center;">DOOR 940x2000 D5-S70R-9XT-09402000</p> <div style="display: flex; align-items: center;">  <div style="margin-left: 20px;"> <p><b>D106-RT</b></p> <p>Right handed - DIN rechts Tempered glass - Gehärtetes Glas Opens outside - Öffnet aussen</p> </div> </div>	1		
VIHM 01-4	Rain deflector - Regenabweiser	1	36x134	1140
KR-0 3524	Screws - Schrauben 3.5x45 C3 for door and window trims - für Tür- und Fensterleisten	26		
KR-0 4001	Screws - Schrauben 4.0x60 C3 for rain deflector - für Regenabweiser	3		
Kood	Devon II 770x770 70	Materjal	File	Leht 15/15

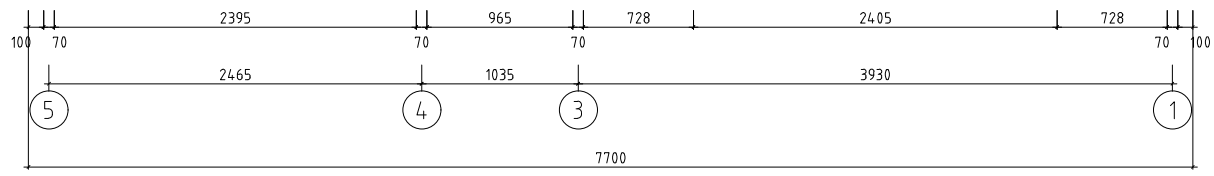
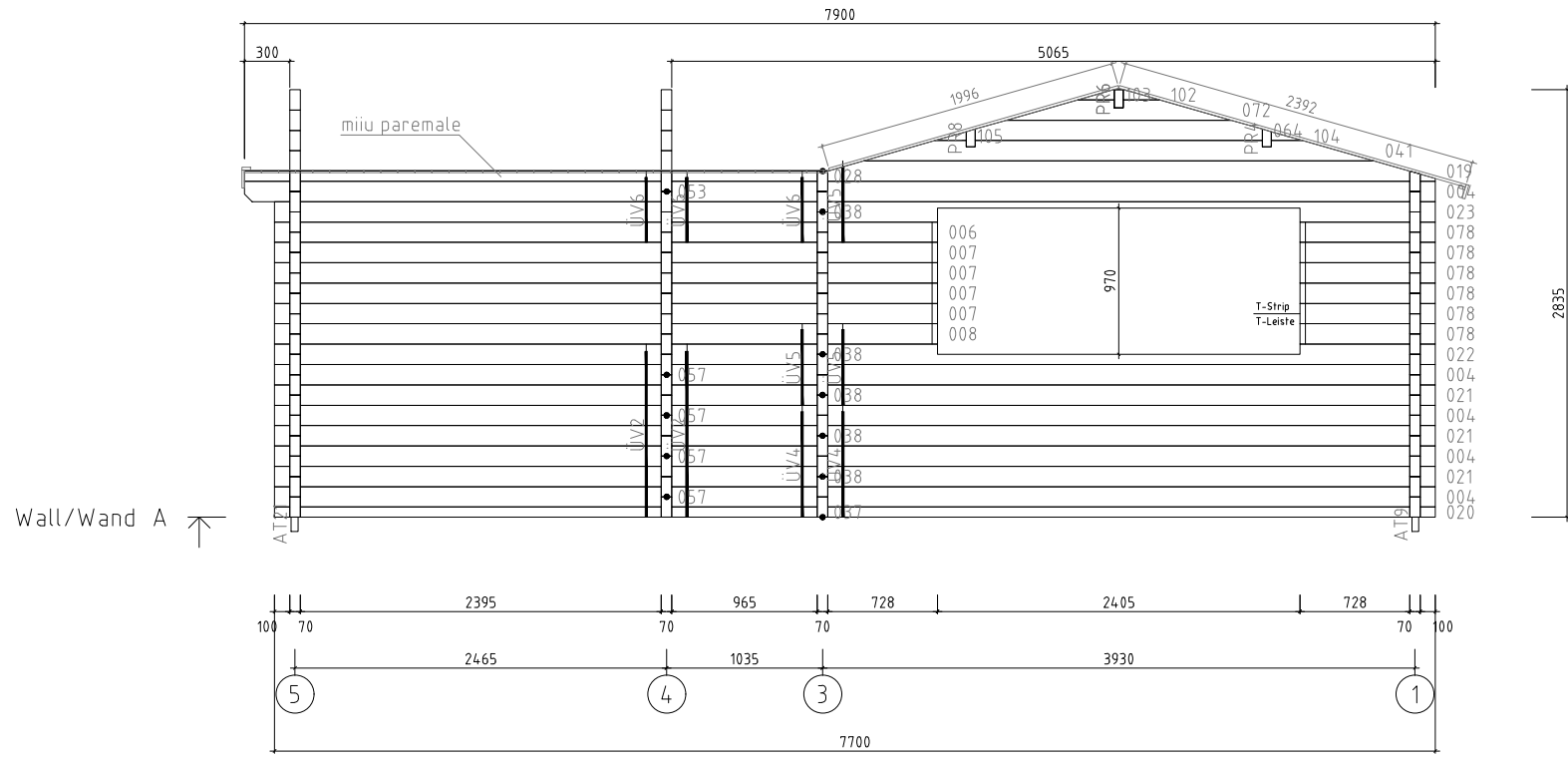

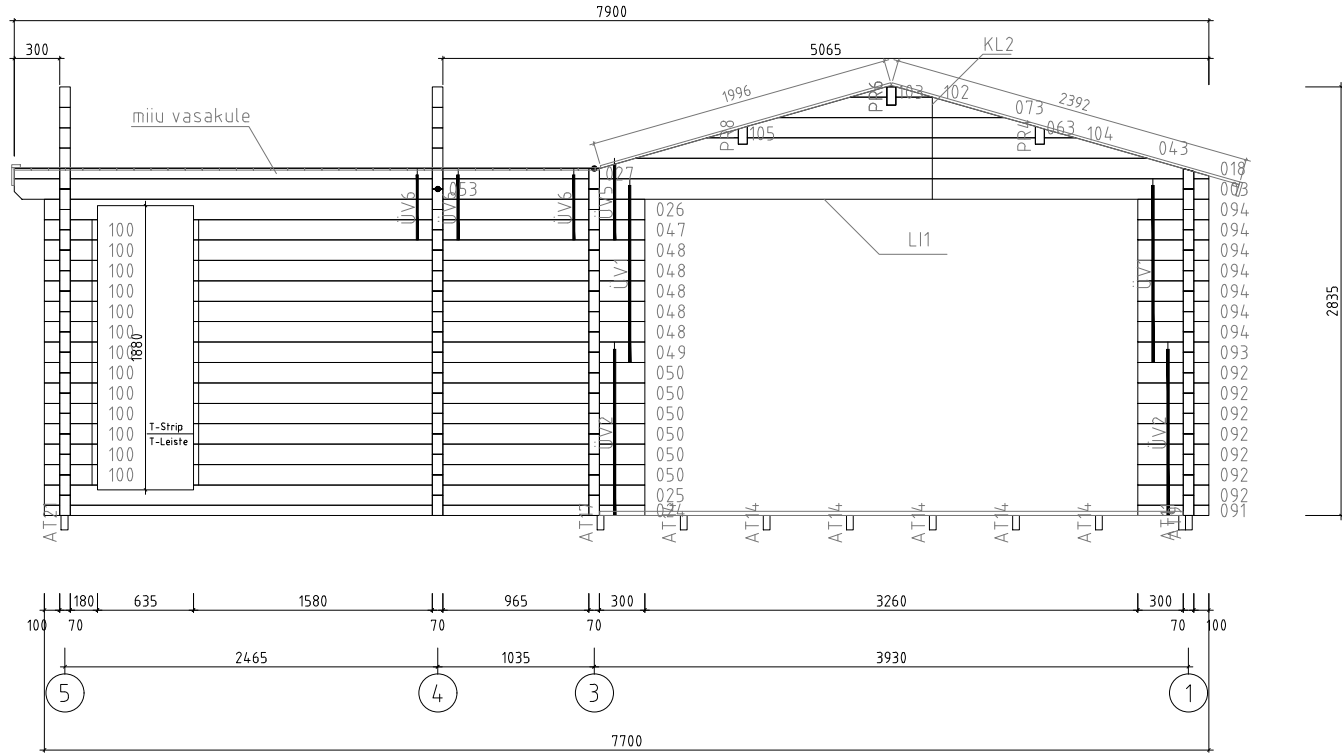

 <a href="http://www.hansa24.com">www.hansa24.com</a>	Name		Devon II 770x770 70		SKU	G0281
	Drawing/Zeichnung		Wall/Wand A		Format	A4
	Profile/Profil	7x13.5	Scale/Maßstab	1:50	Date	26.01.2023

Wall/Wand B ↗

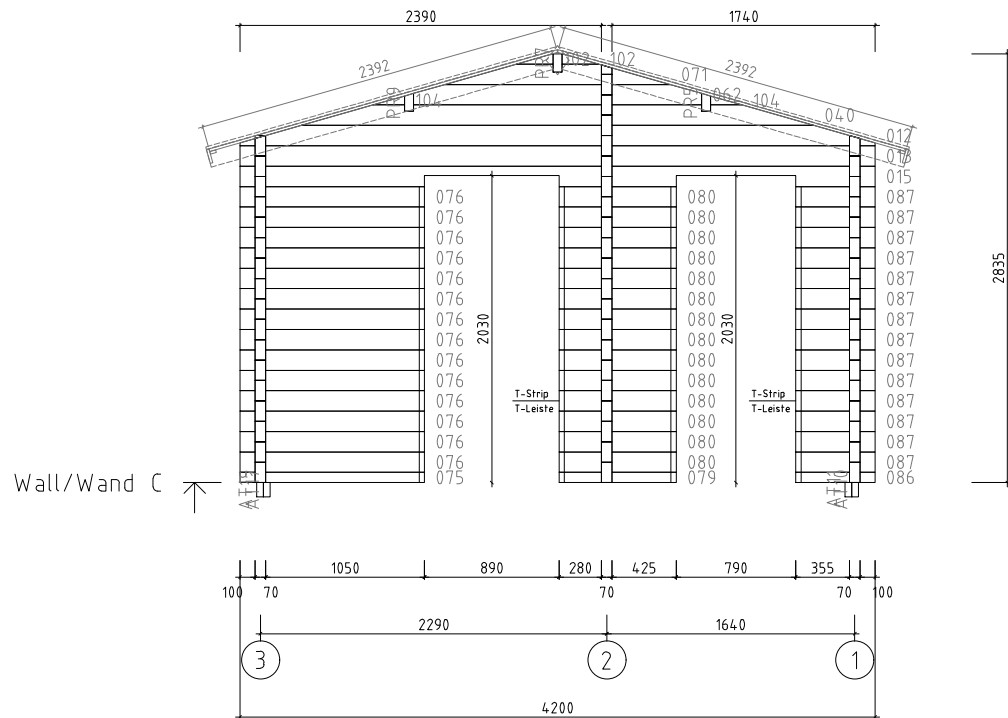

 <a href="http://www.hansa24.com">www.hansa24.com</a>	Name		Devon II 770x770 70		SKU	G0281
	Drawing/Zeichnung		Wall/Wand B		Format	A4
	Profile/Profil	7x13.5	Scale/Maßstab	1:50	Date	26.01.2023



 <a href="http://www.hansa24.com">www.hansa24.com</a>	Name		Devon II 770x770 70		SKU	G0281
	Drawing/Zeichnung		Wall/Wand C		Format	A4
	Profile/Profil	7x13.5	Scale/Maßstab	1:50	Date	26.01.2023

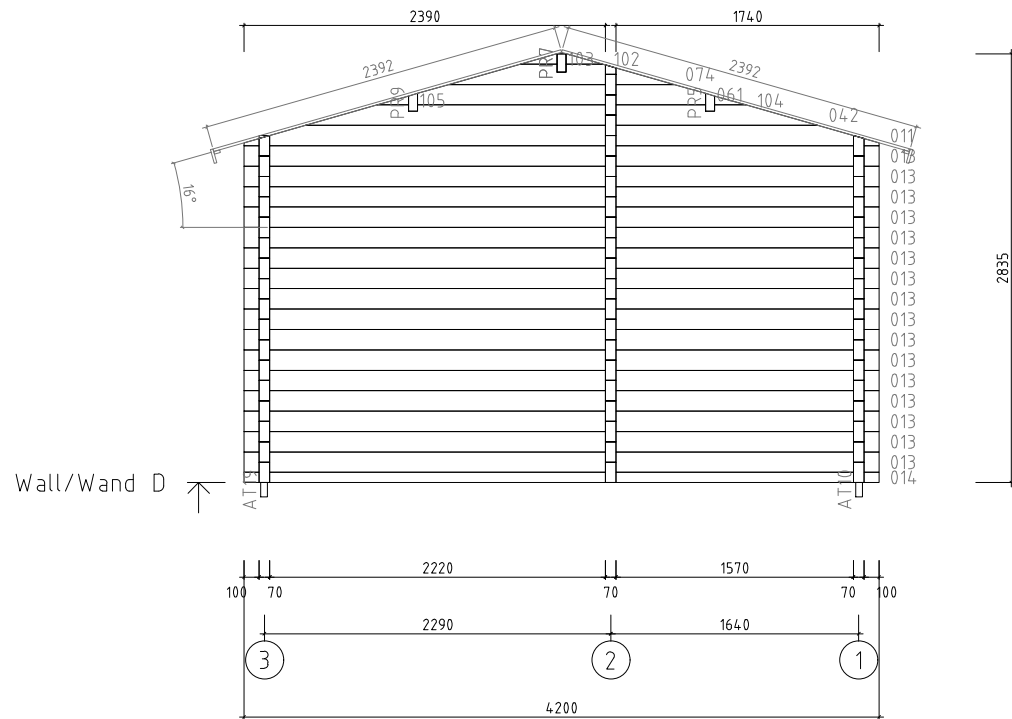

 <a href="http://www.hansa24.com">www.hansa24.com</a>	Name		Devon II 770x770 70		SKU	G0281
	Drawing/Zeichnung		Wall/Wand D		Format	A4
	Profile/Profil	7x13.5	Scale/Maßstab	1:50	Date	26.01.2023

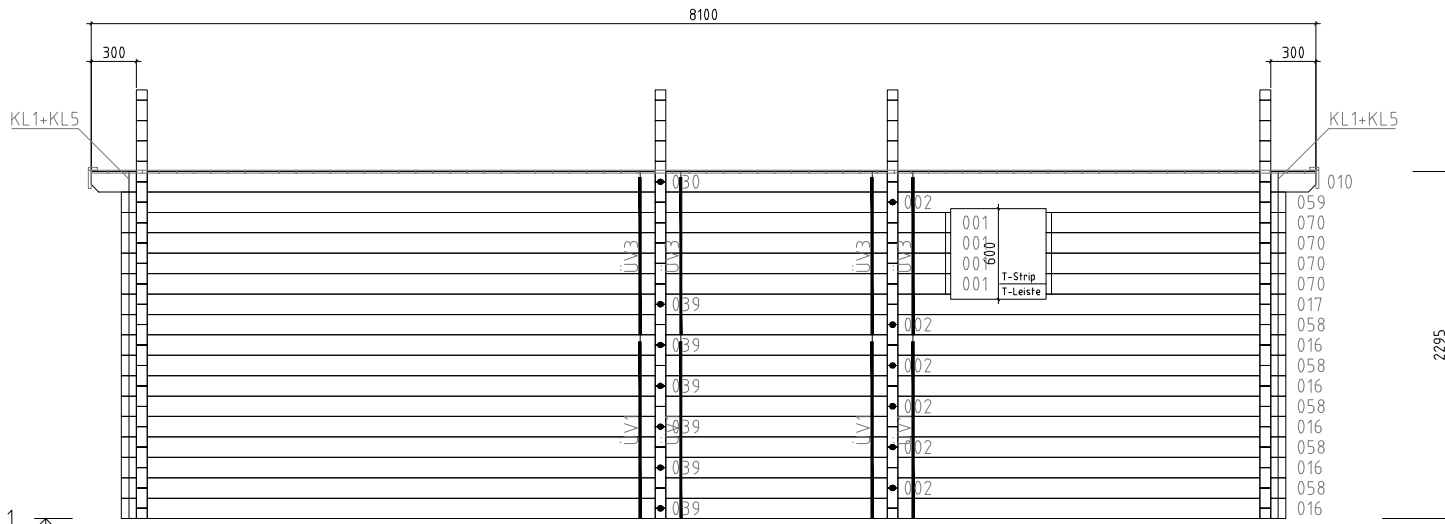

Wall/Wand 1 ↑

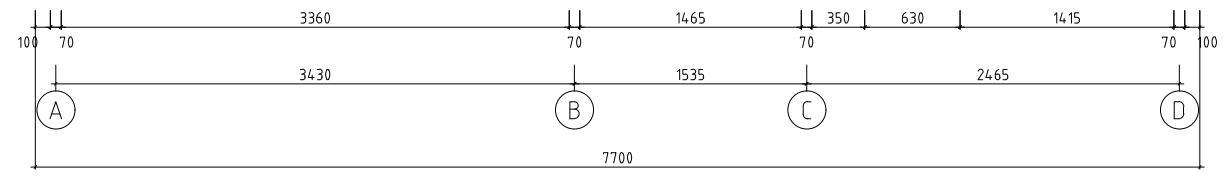

 <a href="http://www.hansa24.com">www.hansa24.com</a>	Name		Devon II 770x770 70		SKU		G0281
	Drawing/Zeichnung		Wall/Wand 1		Format		A4
	Profile/Profil	7x13.5	Scale/Maßstab	1:50	Date	26.01.2023	

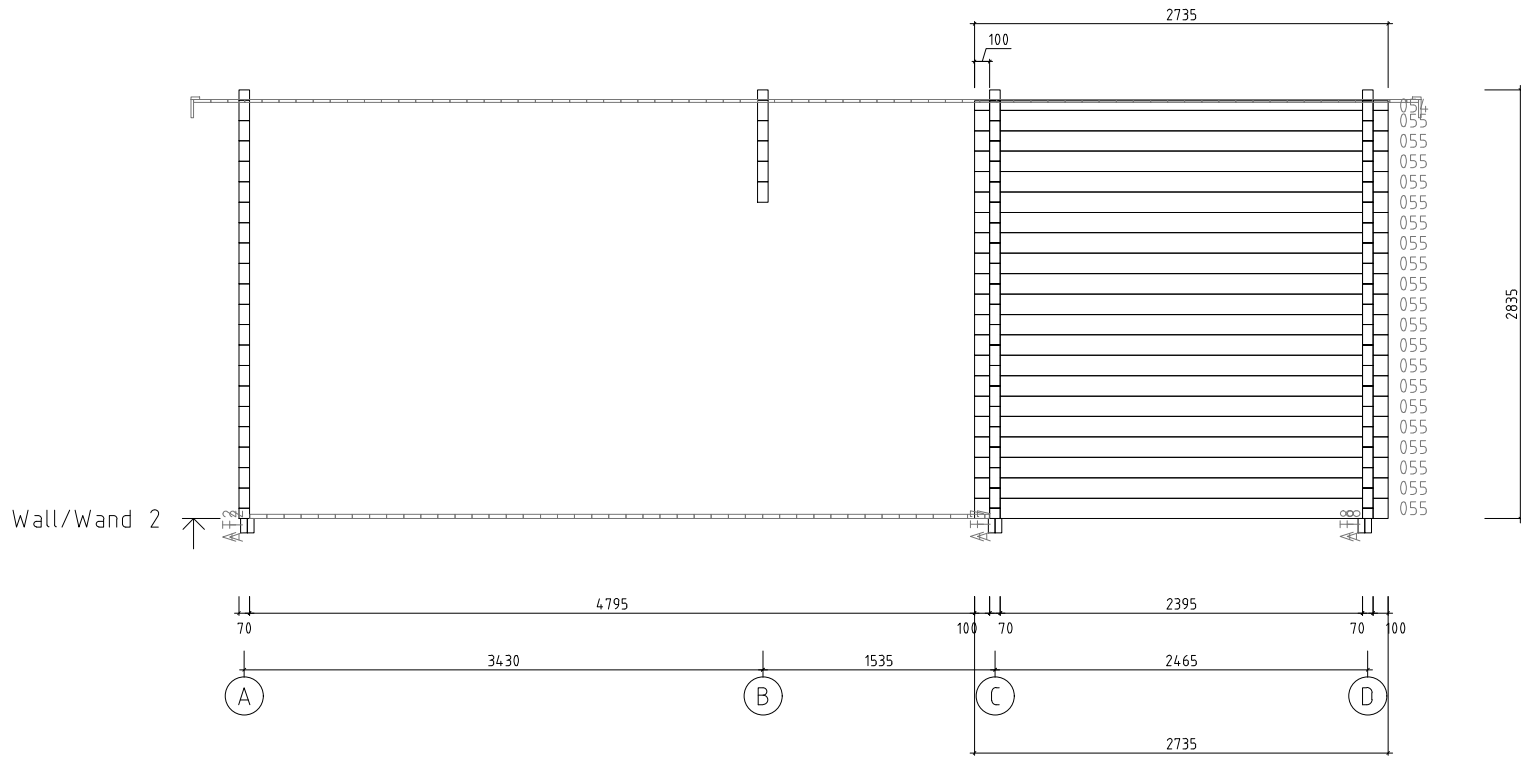

 <a href="http://www.hansa24.com">www.hansa24.com</a>	Name		Devon II 770x770 70		SKU		G0281
	Drawing/Zeichnung		Wall/Wand 2		Format		A4
	Profile/Profil	7x13.5	Scale/Maßstab	1:50	Date	26.01.2023	



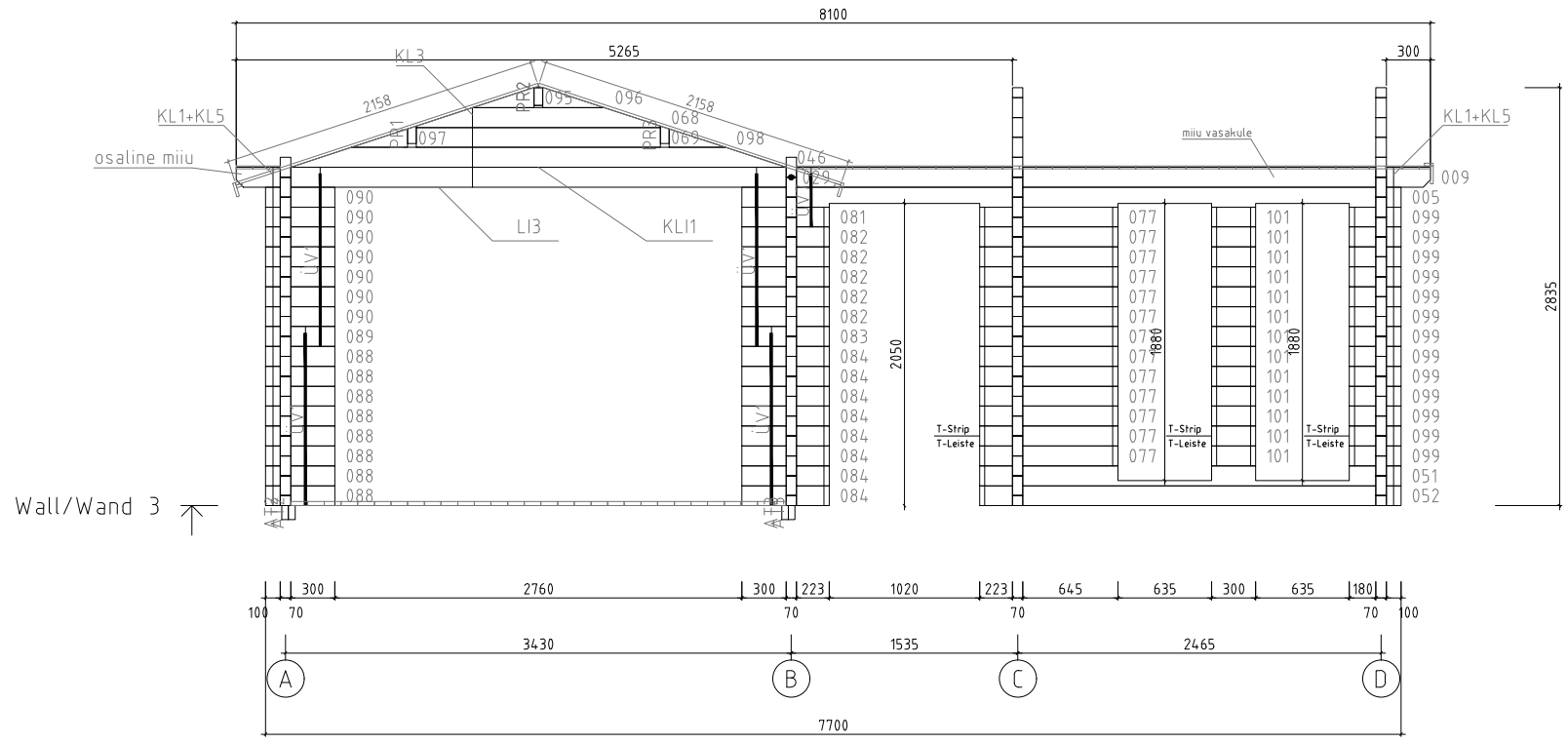

Wall/Wand 3 ↑

 <a href="http://www.hansa24.com">www.hansa24.com</a>	Name		Devon II 770x770 70		SKU	G0281
	Drawing/Zeichnung		Wall/Wand 3		Format	A4
	Profile/Profil	7x13.5	Scale/Maßstab	1:50	Date	26.01.2023

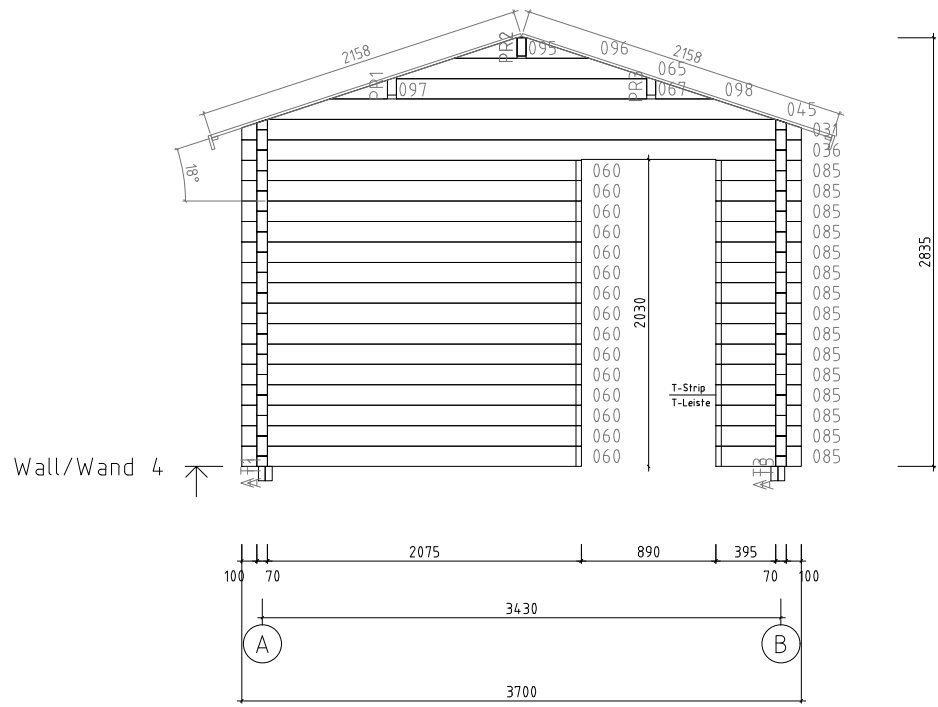

Name	Devon II 770x770 70		SKU	G0281	
Drawing/Zeichnung	Wall/Wand 4		Format	A4	
Profile/Profil	7x13.5	Scale/Maßstab	1:50	Date	26.01.2023

