

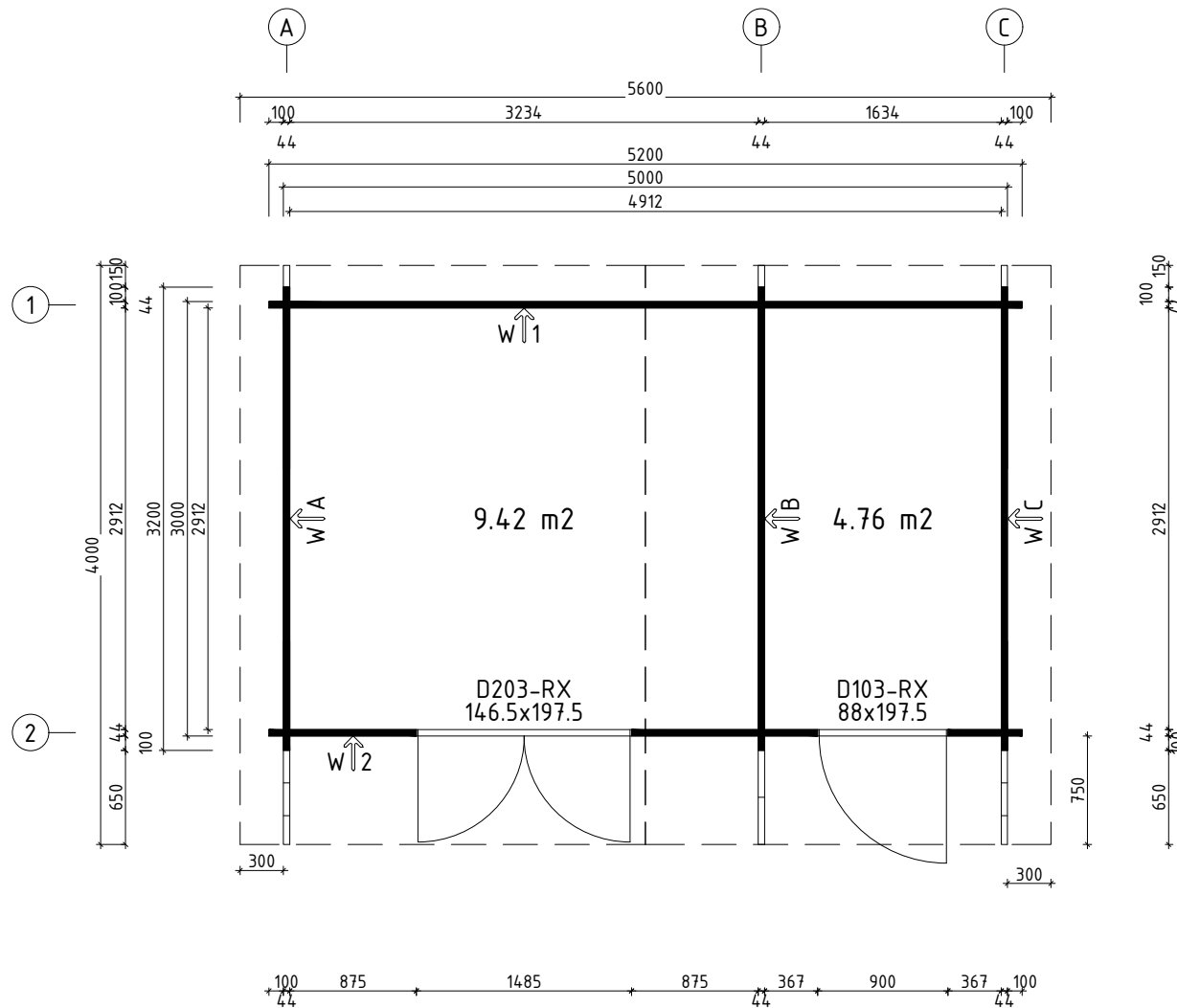









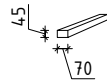
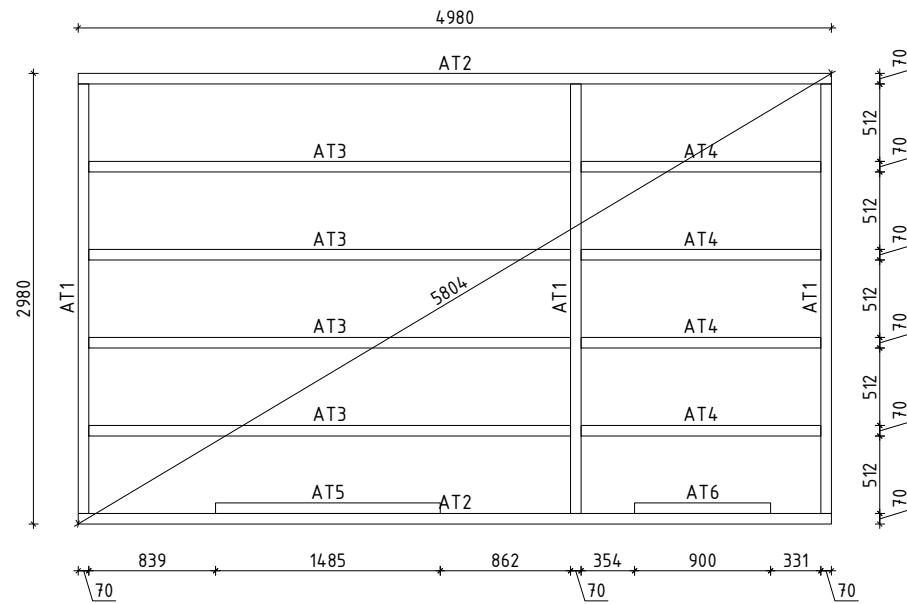



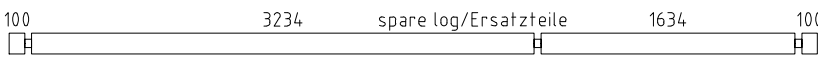



Name	G0296 Double Shed A 520x320+VD 44	SKU	G0296	
Drawing/Zeichnung	3D	Format	A4	
Profile/Profil	4.4x13.5	Scale/Maßstab	Date	24.08.2023

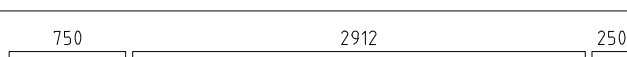
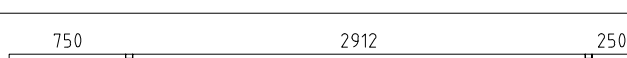

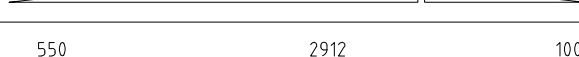
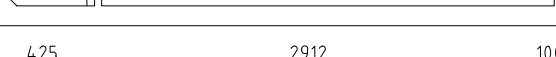
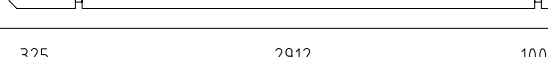

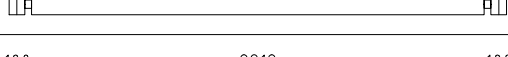
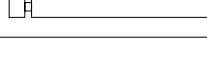
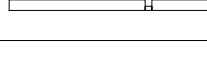
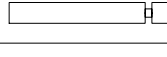
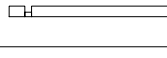
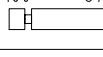





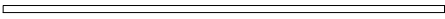

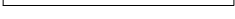

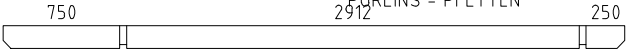









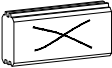



 www.hansa24.com	Name Double Shed A 520x320+VD 44		SKU G0296
	Drawing/Zeichnung Plan_Grundplan		Format A4
	Profile/Profil 4.4x13.5	Scale/Maßstab 1:50	Date 24.08.2023



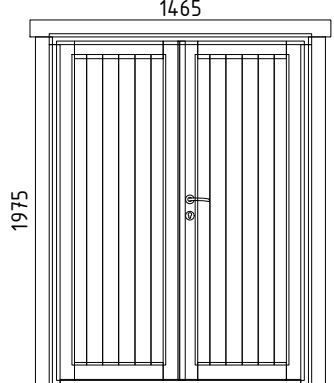

 www.hansa24.com	Name Double Shed A 520x320+VD 44		SKU G0296
	Drawing/Zeichnung Foundation plan_Lagerholzplan		Format A4
	Profile/Profil 4.4x13.5	Scale/Maßstab 1:50	Date 24.08.2023

Pos	Model Double Shed A 520x320+VD 44	Pcs	Profile (mm)	Length (mm)
	Notice! The gable pieces can be partly pre-assembled! Please notice - those differ from the description given in the specification list.			
	Achtung! Die Giebelbohlen können teilweise schon vormontiert sein! Bitte beachten - diese erscheinen nicht ganz so wie in der Teilleiste beschrieben.			
003		1	44x135	5200
001		2	44x135	5200
002		1	44x135	5200
003		15	44x135	5200
004		1	44x68	5200
005		1	44x135	4000
006		1	44x135	4000
007		1	44x52	4000
008		1	44x135	4000
009		2	44x135	3701
010		2	44x135	3650
011		1	44x135	3525
012		2	44x135	3425
013		26	44x135	3200
014		15	44x135	3200
015		1	44x68	1286
016		14	44x135	1286
017		1	44x68	1019
018		14	44x135	1019
019		4	44x68	610
020		1	44x68	511
021		14	44x135	511
AT2	FOUNDATION BEAMS (impregnated) - FUNDAMENTHÖLZER (imprägniert) 	2	70x45	4980
Kood	Double Shed A 520x320+VD 44	Materjal	File	Leht 1/5

Pos	Model Double Shed A 520x320+VD 44	Pcs	Profile (mm)	Length (mm)
AT3	FOUNDATION BEAMS (impregnated) - FUNDAMENTHÖLZER (imprägniert) 	4	70x45	3185
AT1	FOUNDATION BEAMS (impregnated) - FUNDAMENTHÖLZER (imprägniert) 	3	70x45	2840
AT4	FOUNDATION BEAMS (impregnated) - FUNDAMENTHÖLZER (imprägniert) 	4	70x45	1585
AT5	FOUNDATION BEAMS (impregnated) - FUNDAMENTHÖLZER (imprägniert) 	1	70x45	1485
AT6	FOUNDATION BEAMS (impregnated) - FUNDAMENTHÖLZER (imprägniert) 	1	70x45	900
PR1	PURLINS - PFETTEN 	4	70x145	4000
	ROOF BOARDS - DACHBRETTER 	72+1	113x18	2817
	FLOOR BOARDS - FUSSBODENBRETTER 	44+1	113x18	2907
	Ceiling mouldings - Deckenleisten (inside and outside - innen und außen) 		15x28	49 rm/lfm
	Floor mouldings - Fussbodenleisten 		18x40	23 rm/lfm
RLA 01-1	Eave board - Traufenbrett 18x95 	2	18x95	4000
RLI01-1	Eave slat - Traufenleiste 18x40 		18x40	9 rm/lfm
VLA 02-1	Gable board - Giebelbrett 18x120 	4	18x120	2917
VKL 01-1	Gable cover slat - Giebeldeckleiste 18x40 	4	18x40	2917
GD01	Diamond - Diamant 	2		
LK	Hit block - Schlaghölzer 	3		
N-0 2503	Nails - Nägel 2.5x60 for floor boards - für Fussbodenbretter 	528		
N-0 2501	Nails - Nägel vierkant 2.5x50 for ceiling boards - für Dachbretter 	576		
KR-0 3001	Screws - Schrauben 3.0x30 for ceiling mouldings - für Deckenleisten 	86		
KR-0 3002	Screws - Schrauben 3.0x30 for eave slats - für Traufenleisten 	20		
KR-0 3003	Screws - Schrauben 3.0x30 for floor mouldings - für Fussbodenleisten 	46		
KR-0 3523	Screws - Schrauben 3.5x45 C3 for diamonds - für Diamanten 	4		
KR-0 3525	Screws - Schrauben 3.5x45 C3 for eave boards - für Traufenbretter 	20		
KR-0 3527	Screws - Schrauben 3.5x45 C3 for gable boards - für Giebelbretter 	24		
KR-0 3521	Screws - Schrauben 3.5x45 C3 for gable cover slats - für Giebeldeckleisten 	24		
Kood	Double Shed A 520x320+VD 44	Materjal	File	Leht 2/5

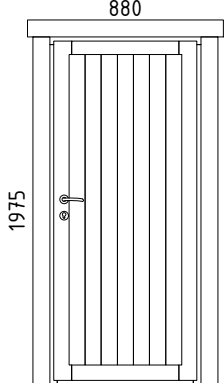
Pos	Model Double Shed A 520x320+VD 44	Pcs	Profile (mm)	Length (mm)
	<p data-bbox="606 134 909 197">DOOR 1465x1975 D5-D44R-XXX-14651975</p>  <p data-bbox="734 224 845 257">D203-RX</p> <p data-bbox="734 280 1085 347">Right handed - DIN rechts Opens outside - Öffnet aussen</p>	1		
KR-0 3524	<p data-bbox="263 616 1053 683">Screws - Schrauben 3.5x45 C3 for door and window trims - für Tur- und Fensterleisten</p> 	28		
Kood	Double Shed A 520x320+VD 44	Materjal	File	Leht 4/5

Pos	Model Double Shed A 520x320+VD 44	Pcs	Profile (mm)	Length (mm)
	DOOR 880x1975 D5-S44R-XXX-08801975  D103-RX Right handed - DIN rechts Opens outside - Öffnet aussen	1		
KR-0 3524	Screws - Schrauben 3.5x45 C3 for door and window trims - für Tür- und Fensterleisten 	26		
Kood	Double Shed A 520x320+VD 44	Materjal	File	Leht 5/5

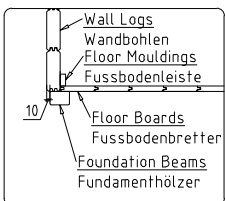
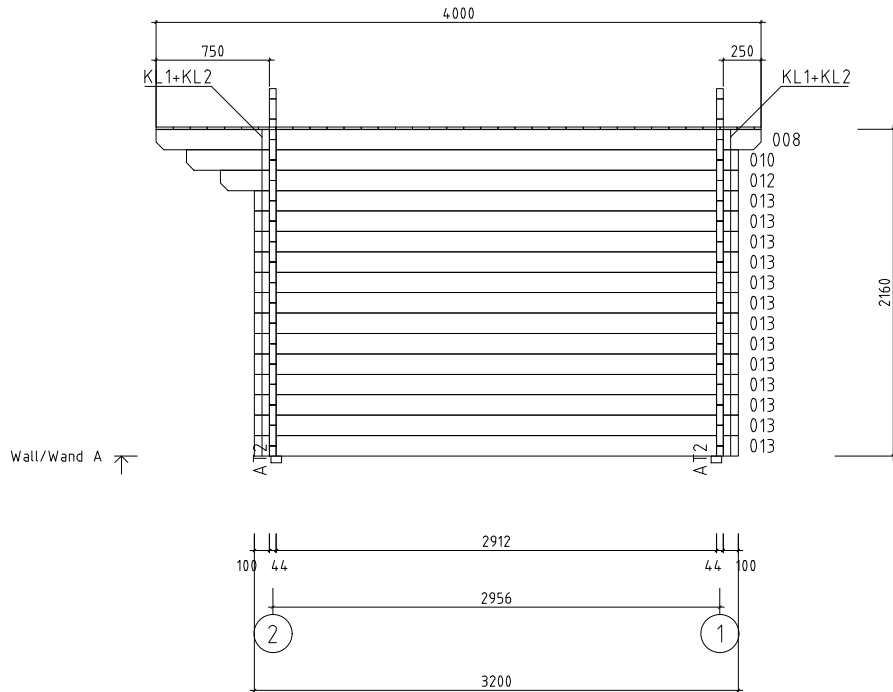
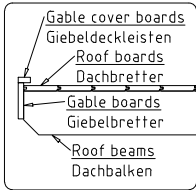

	Name Double Shed A 520x320+VD 44		SKU G0296
	Drawing/Zeichnung Wall/Wand A		Format A4
Profile/Profil 4.4x13.5	Scale/Maßstab 1:50	Date 24.08.2023	

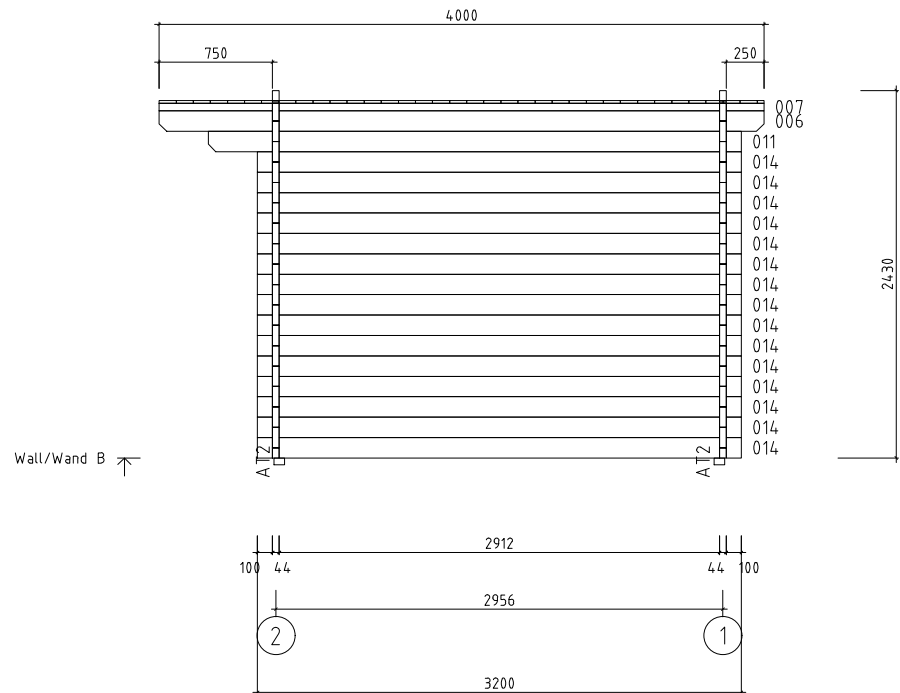

 www.hansa24.com	Name Double Shed A 520x320+VD 44		SKU G0296
	Drawing/Zeichnung Wall/Wand B		Format A4
	Profile/Profil 4.4x13.5	Scale/Maßstab 1:50	Date 24.08.2023

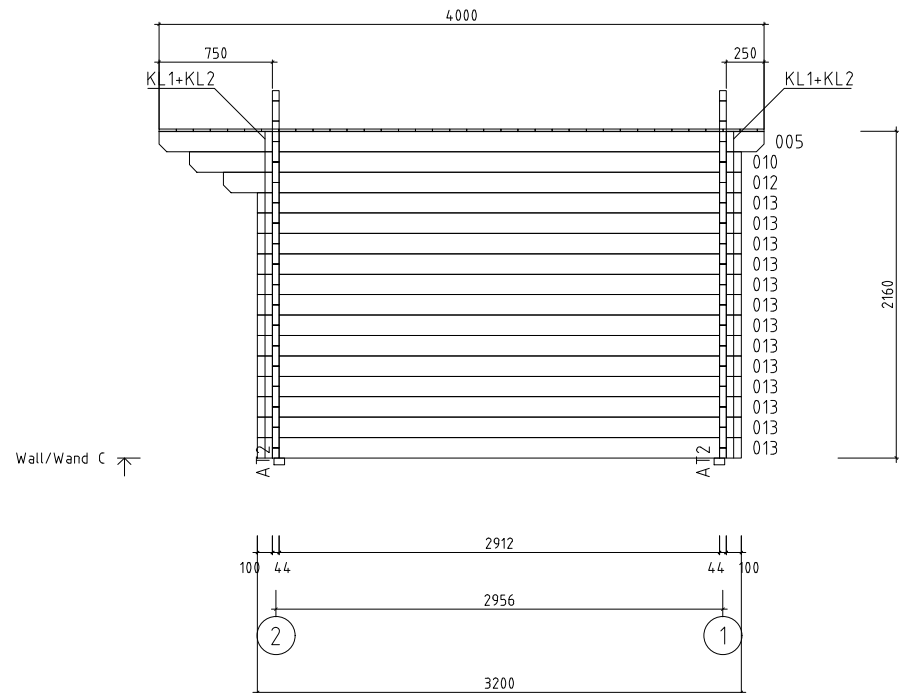

 www.hansa24.com	Name Double Shed A 520x320+VD 44		SKU G0296
	Drawing/Zeichnung Wall/Wand C		Format A4
	Profile/Profil 4.4x13.5	Scale/Maßstab 1:50	Date 24.08.2023

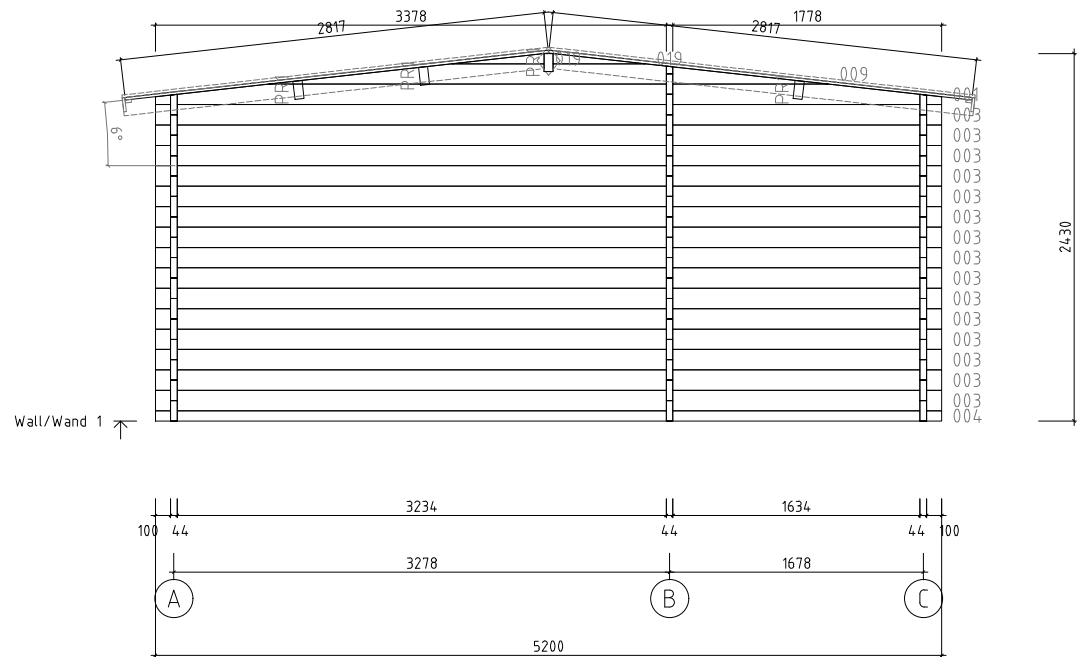
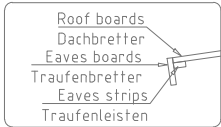

Name	Double Shed A 520x320+VD 44	SKU	G0296
Drawing/Zeichnung	Wall/Wand 1	Format	A4
Profile/Profil	4.4x13.5	Scale/Maßstab	1:50
		Date	24.08.2023

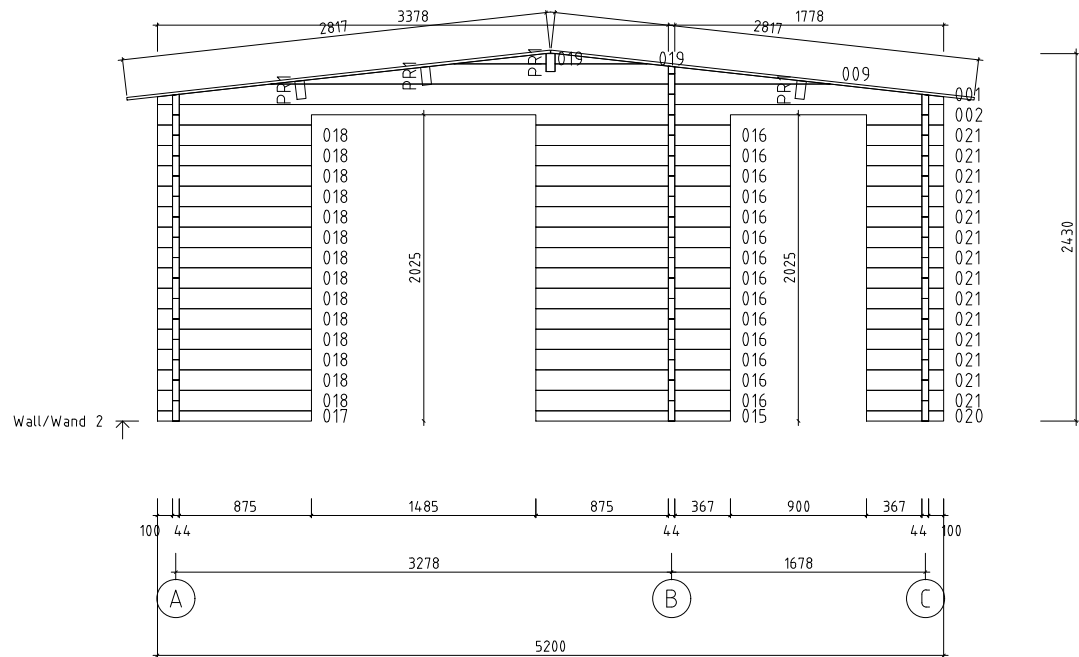

 www.hansa24.com	Name Double Shed A 520x320+VD 44		SKU G0296
	Drawing/Zeichnung Wall/Wand 2		Format A4
	Profile/Profil 4.4x13.5	Scale/Maßstab 1:50	Date 24.08.2023