

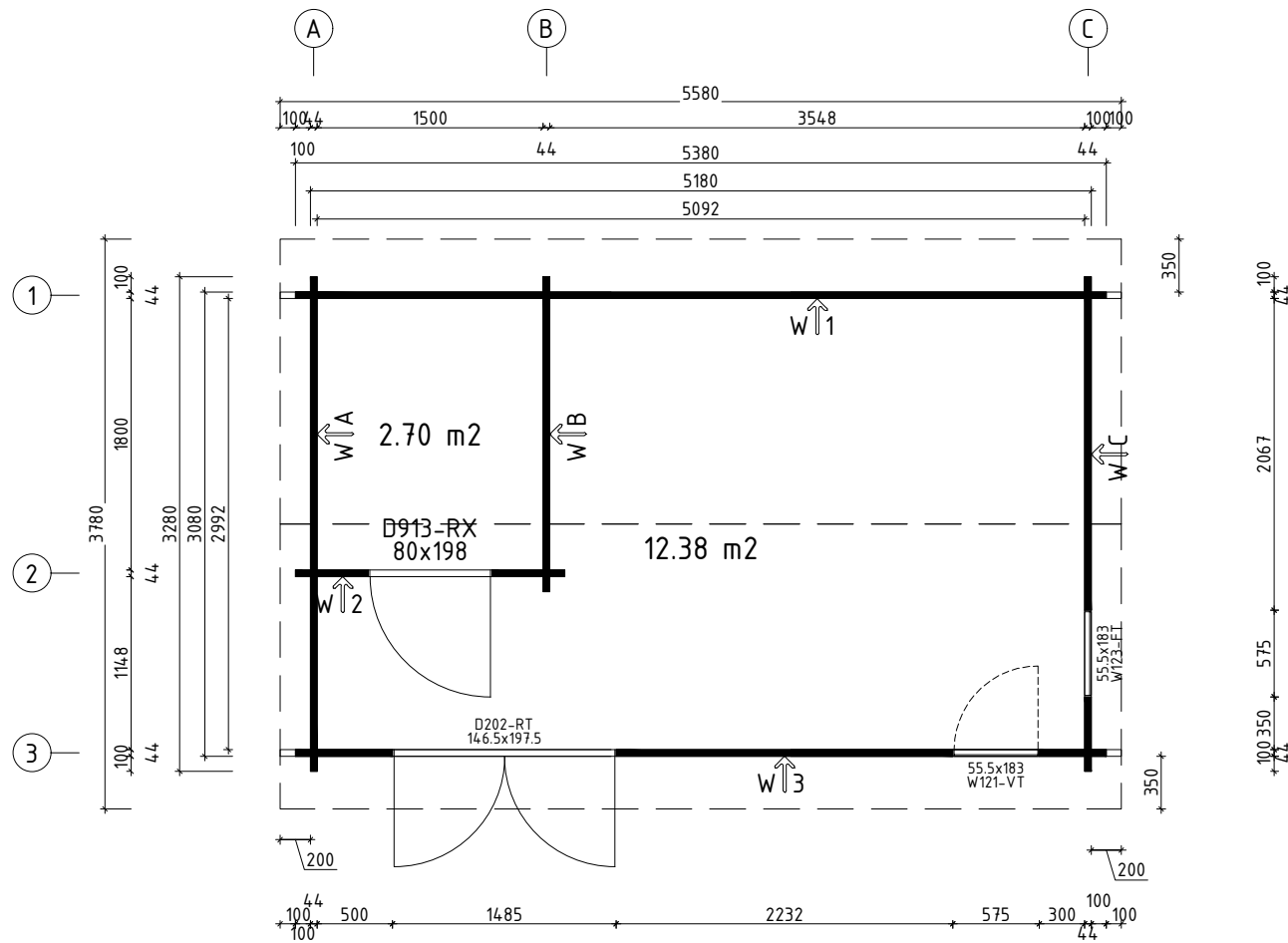







Name	Mia 1 328x538+VD 44	SKU	G0304	
Drawing/Zeichnung	3D	Format	A4	
Profile/Profil	4.4x13.5	Scale/Maßstab	Date	23.05.2023

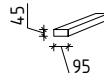
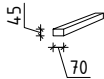
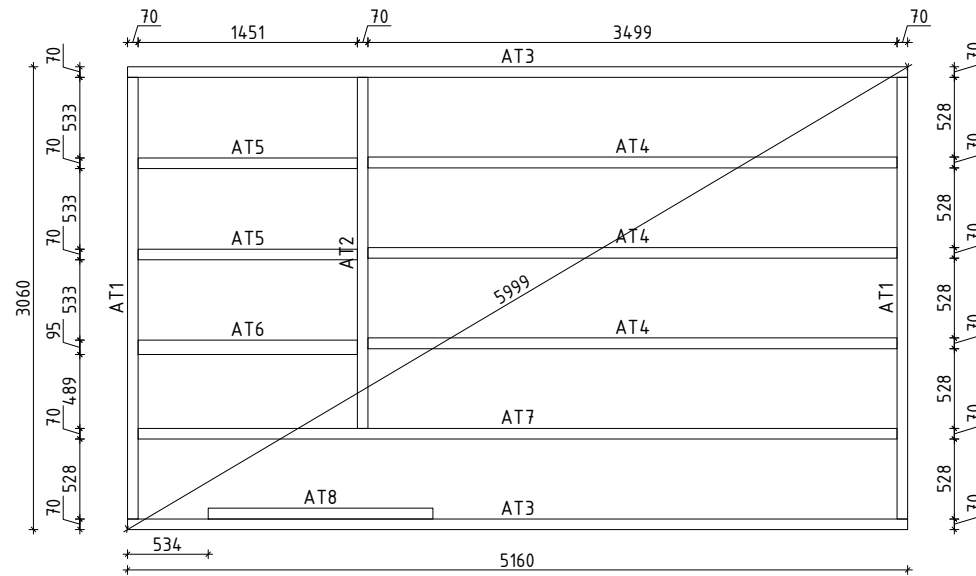



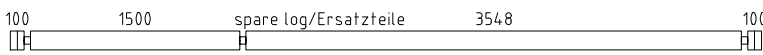
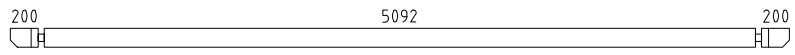
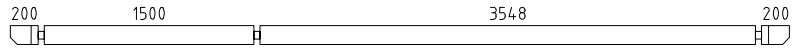
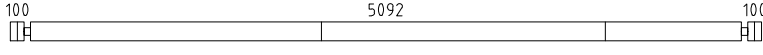
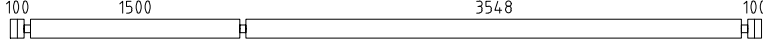
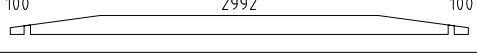
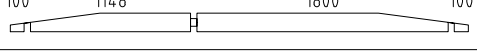
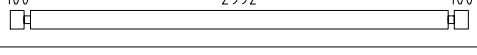
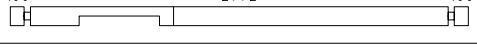
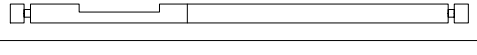
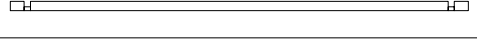
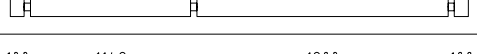
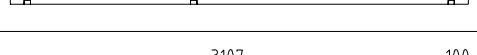
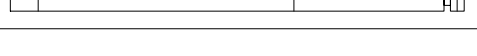
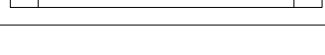

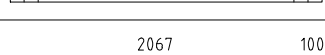
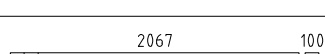
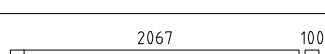
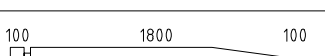
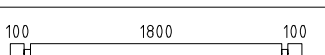
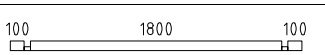
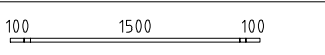
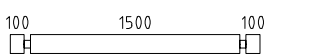
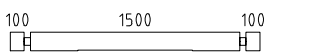



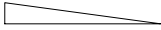
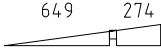
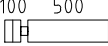





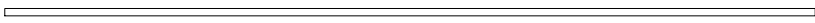

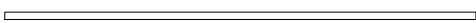

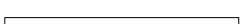
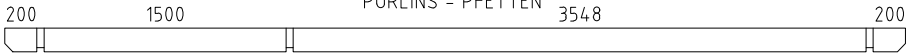
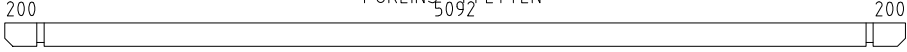
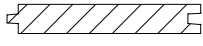
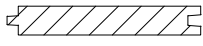
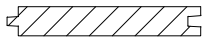
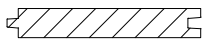







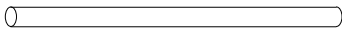
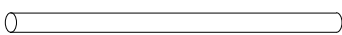







 www.hansa24.com	Name		Mia 1 328x538+VD 44	SKU	G0304
	Drawing/Zeichnung		Plan_Grundplan	Format	A4
	Profile/Profil	4.4x13.5	Scale/Maßstab	1:50	Date







 www.hansa24.com	Name		Mia 1 328x538+VD 44	SKU	G0304
	Drawing/Zeichnung		Plan_Grundplan	Format	A4
	Profile/Profil	4.4x13.5	Scale/Maßstab	1:50	Date



Pos	Model Mia 1 328x538+VD 44	Pcs	Profile (mm)	Length (mm)
	Notice! The gable pieces can be partly pre-assembled! Please notice - those differ from the description given in the specification list.			
	Achtung! Die Giebelbohlen können teilweise schon vormontiert sein! Bitte beachten - diese erscheinen nicht ganz so wie in der Teilliste beschrieben.			
004		1	44x135	5380
001		1	44x135	5580
002		1	44x135	5580
003		1	44x135	5380
004		16	44x135	5380
005		1	44x135	3280
006		1	44x135	3280
007		1	44x135	3280
008		1	44x135	3280
009		1	44x135	3280
010		1	44x68	3280
011		16	44x135	3280
012		1	44x68	3280
013		1	44x135	3251
014		6	44x135	2232
015		6	44x135	2232
016		2	44x135	2232
017		6	44x135	2211
018		2	44x135	2211
019		5	44x135	2211
020		1	44x135	2088
021		16	44x135	2088
022		1	44x68	2088
023		1	44x26	1788
024		2	44x135	1788
025		1	44x135	1788
Kood	Mia 1 328x538+VD 44	Materjal	File	Leht 1/7

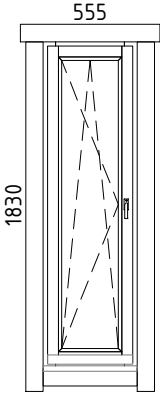

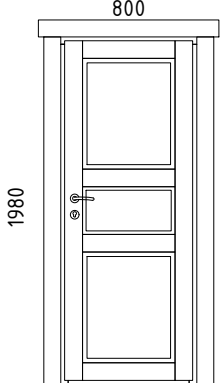

Pos	Model Mia 1 328x538+VD 44	Pcs	Profile (mm)	Length (mm)
026		4	44x131	967
027		1	44x131	967
028		15	44x135	644
029		13	44x135	494
030		30	44x135	484
031		14	44x135	444
032		1	44x131	418
AT6	FOUNDATION BEAMS (impregnated) - FUNDAMENTHÖLZER (imprägniert) 	1	95x45	1451
AT3	FOUNDATION BEAMS (impregnated) - FUNDAMENTHÖLZER (imprägniert) 	2	70x45	5160
AT7	FOUNDATION BEAMS (impregnated) - FUNDAMENTHÖLZER (imprägniert) 	1	70x45	5020
AT4	FOUNDATION BEAMS (impregnated) - FUNDAMENTHÖLZER (imprägniert) 	3	70x45	3499
AT1	FOUNDATION BEAMS (impregnated) - FUNDAMENTHÖLZER (imprägniert) 	2	70x45	2920
AT2	FOUNDATION BEAMS (impregnated) - FUNDAMENTHÖLZER (imprägniert) 	1	70x45	2322
AT8	FOUNDATION BEAMS (impregnated) - FUNDAMENTHÖLZER (imprägniert) 	1	70x45	1485
AT5	FOUNDATION BEAMS (impregnated) - FUNDAMENTHÖLZER (imprägniert) 	2	70x45	1451
PR1	PURLINS - PFETTEN 	2	70x145	5580
PR2	PURLINS - PFETTEN 	1	70x145	5580
	ROOF BOARDS - DACHBRETTER 	100+2	113x18	1907
	FLOOR BOARDS - FUSSBODENBRETTER 	33+2	113x18	2987
	FLOOR BOARDS - FUSSBODENBRETTER 	14	113x18	1795
	FLOOR BOARDS - FUSSBODENBRETTER 	13	113x18	1143
	Ceiling mouldings - Deckenleisten 		15x28	50 rm/lfm
	Floor mouldings - Fussbodenleisten 		18x40	24 rm/lfm
RLA 01-1	Eave board - Traufenbrett 18x95 	2	18x95	5580
Kood	Mia 1 328x538+VD 44	Materjal	File	Leht 2/7

Pos	Model Mia 1 328x538+VD 44		Pcs	Profile (mm)	Length (mm)
RLI01-1	Eave slat - Traufenleiste 18x40			18x40	12.16 cm/lfm
VLA 02-1	Gable board - Giebelbrett 18x120	7.7° 	4	18x120	2007
VKL 01-1	Gable cover slat - Giebeldeckleiste 18x40		4	18x40	2007
ÜV1	Metal bar - Metallstange Ø10		5	Ø10	1170
ÜV2	Metal bar - Metallstange Ø10		1	Ø10	1040
GD01	Diamond - Diamant		2		
LK	Hit block - Schlaghölzer		3		
N-0 2503	Nails - Nägel 2.5x60 for floor boards - für Fussbodenbretter		664		
N-0 2501	Nails - Nägel vierkant 2.5x50 for ceiling boards - für Dachbretter		600		
KR-0 3001	Screws - Schrauben 3.0x30 for ceiling mouldings - für Deckenleisten		88		
KR-0 3002	Screws - Schrauben 3.0x30 for eave slats - für Traufenleisten		24		
KR-0 3003	Screws - Schrauben 3.0x30 for floor mouldings - für Fussbodenleisten		52		
KR-0 3523	Screws - Schrauben 3.5x45 C3 for diamonds - für Diamanten		4		
KR-0 3525	Screws - Schrauben 3.5x45 C3 for eave boards - für Traufenbretter		24		
KR-0 3527	Screws - Schrauben 3.5x45 C3 for gable boards - für Giebelbretter		16		
KR-0 3521	Screws - Schrauben 3.5x45 C3 for gable cover slats - für Giebeldeckleisten		16		
KR-0 5080	Screws - Schrauben 5.0x100 for foundation beams - für Fundamenthölzer		52		
KL1	Threaded rod - Gewindestange M8		4		2000
KL2	Threaded rod - Gewindestange M8		4		325
	Nut - Mutter M8		4		
	Washer - Scheibe M8x24		4		
	Extended nut - Langmutter M8		4		
	Drive-in nut - Einschlagmutter M8		4		
Kood	Mia 1 328x538+VD 44	Materjal	File	Leht	3/7

Pos	Model Mia 1 328x538+VD 44	Pcs	Profile (mm)	Length (mm)
	WINDOW 555x1830 W5-S44F-0XT-05551830 W123-FT Tempered glass - Gehärtetes Glas Fixed - Fix	1		
VIHM 01-1	Rain deflector - Regenabweiser	1	36x134	755
KR-0 3524	Screws - Schrauben 3.5x45 C3 for door and window trims - für Tür- und Fensterleisten	24		
KR-0 4001	Screws - Schrauben 4.0x60 C3 for rain deflector - für Regenabweiser	2		
Kood	Mia 1 328x538+VD 44	Materjal	File	Leht 4/7

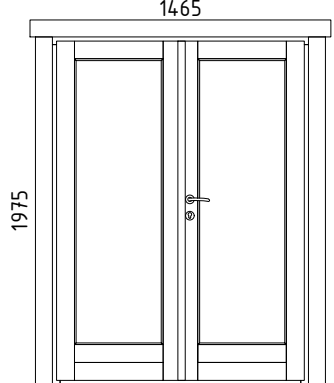
Pos	Model Mia 1 328x538+VD 44	Pcs	Profile (mm)	Length (mm)	
	<p>WINDOW 555x1830 W5-S44V-0XT-05551830</p>  <p>555 1830</p> <p><u>W121-VT</u> Left handed - DIN links Tempered glass - Gehärtetes Glas Opens inside - Öffnet innen</p>	1			
VIHM 01-1	Rain deflector - Regenabweiser		1	36x134	755
KR-0 3524	Screws - Schrauben 3.5x45 C3 for door and window trims - für Tür- und Fensterleisten		24		
KR-0 4001	Screws - Schrauben 4.0x60 C3 for rain deflector - für Regenabweiser		2		
Kood	Mia 1 328x538+VD 44	Materjal	File	Leht	5/7

Pos	<p>Model Mia 1 328x538+VD 44</p>	Pcs	Profile (mm)	Length (mm)
	<p>DOOR 800x1980 D0-I44R-XXX-08001980</p>  <p>800</p> <p>1980</p> <p>D913-RX</p> <p>Right handed - DIN rechts Opens outside - Öffnet aussen</p>	1		
KR-0 3524	<p>Screws - Schrauben 3.5x45 C3 for door and window trims - für Tur- und Fensterleisten</p> 	26		
Kood	Mia 1 328x538+VD 44	Materjal	File	Leht 6/7

Pos	Model Mia 1 328x538+VD 44	Pcs	Profile (mm)	Length (mm)
	D00R 1465x1975 D5-D44R-0XT-14651975  D202-RT Right handed - DIN rechts Tempered glass - Gehärtetes Glas Opens outside - Öffnet aussen	1		
VIHM 01-2	Rain deflector - Regenabweiser	 1	36x134	1665
KR-0 3524	Screws - Schrauben 3.5x45 C3 for door and window trims - für Tür- und Fensterleisten	 28		
KR-0 4001	Screws - Schrauben 4.0x60 C3 for rain deflector - für Regenabweiser	 4		
Kood	Mia 1 328x538+VD 44	Materjal	File	Leht 7/7

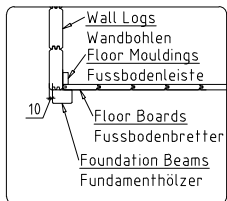
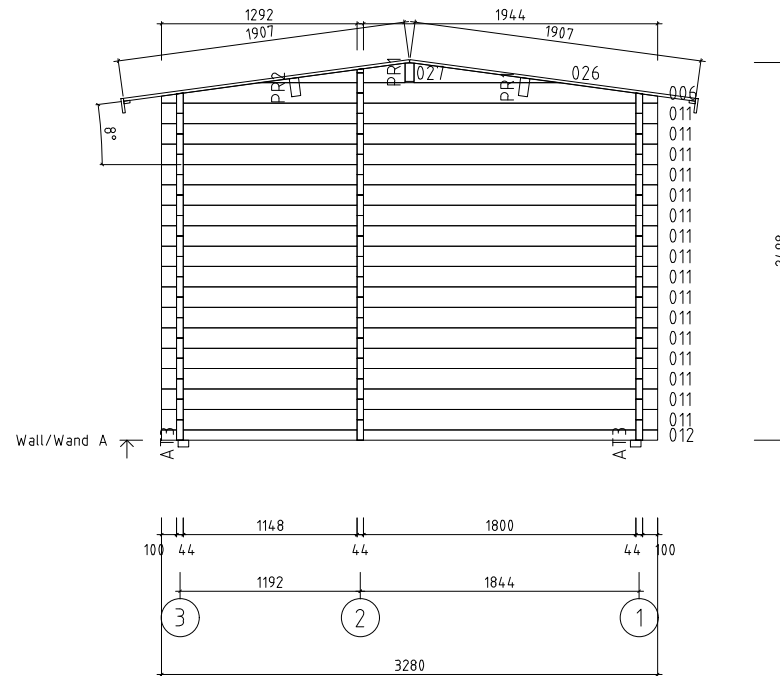
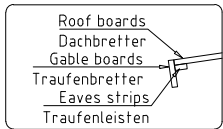

 www.hansa24.com	Name		Mia 1 328x538+VD 44	SKU	G0304
	Drawing/Zeichnung		Wall/Wand A	Format	A4
	Profile/Profil	4.4x13.5	Scale/Maßstab	1:50	Date

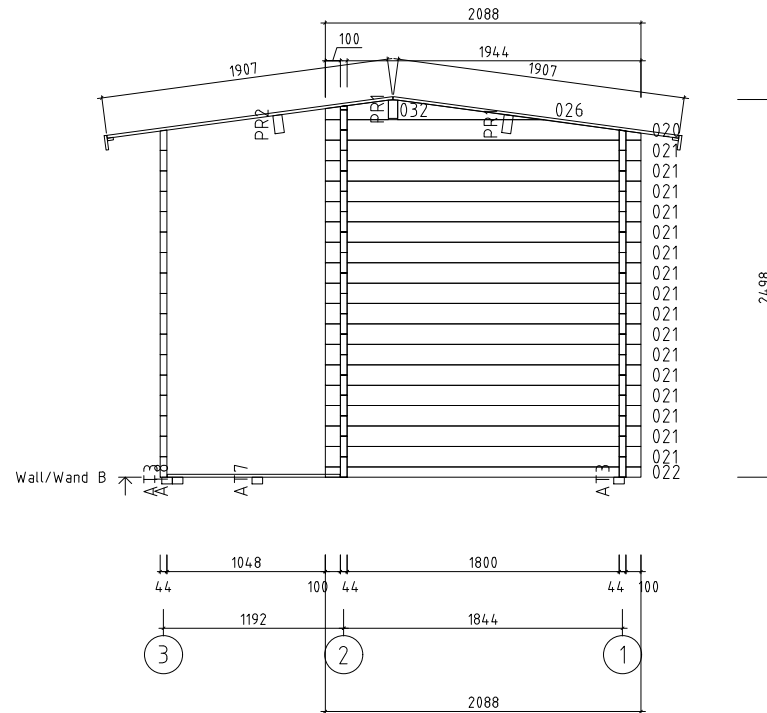

Name	Mia 1 328x538+VD 44	SKU	G0304
Drawing/Zeichnung	Wall/Wand B	Format	A4
Profile/Profil	4.4x13.5	Scale/Maßstab	1:50
		Date	23.05.2023

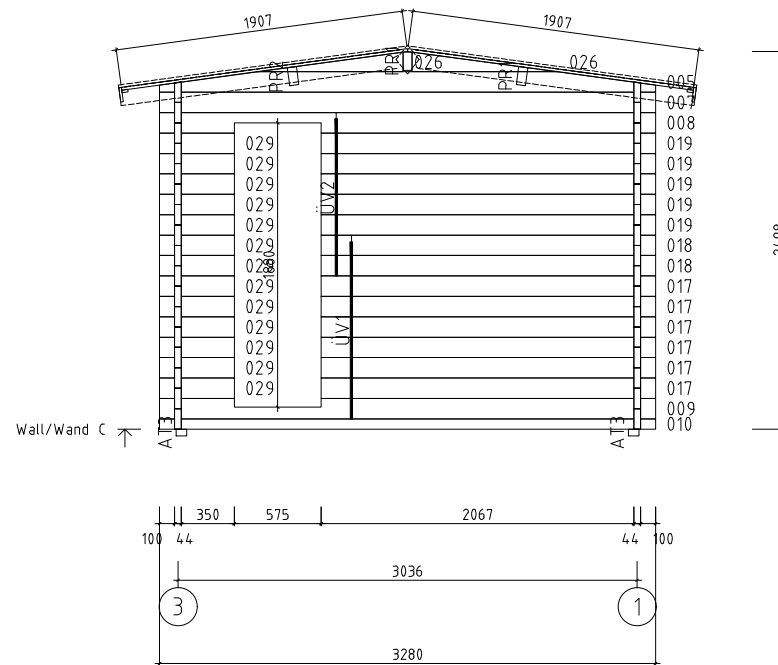

 www.hansa24.com	Name		Mia 1 328x538+VD 44	SKU	G0304	
	Drawing/Zeichnung			Wall/Wand C	Format	A4
	Profile/Profil	4.4x13.5	Scale/Maßstab	1:50	Date	23.05.2023

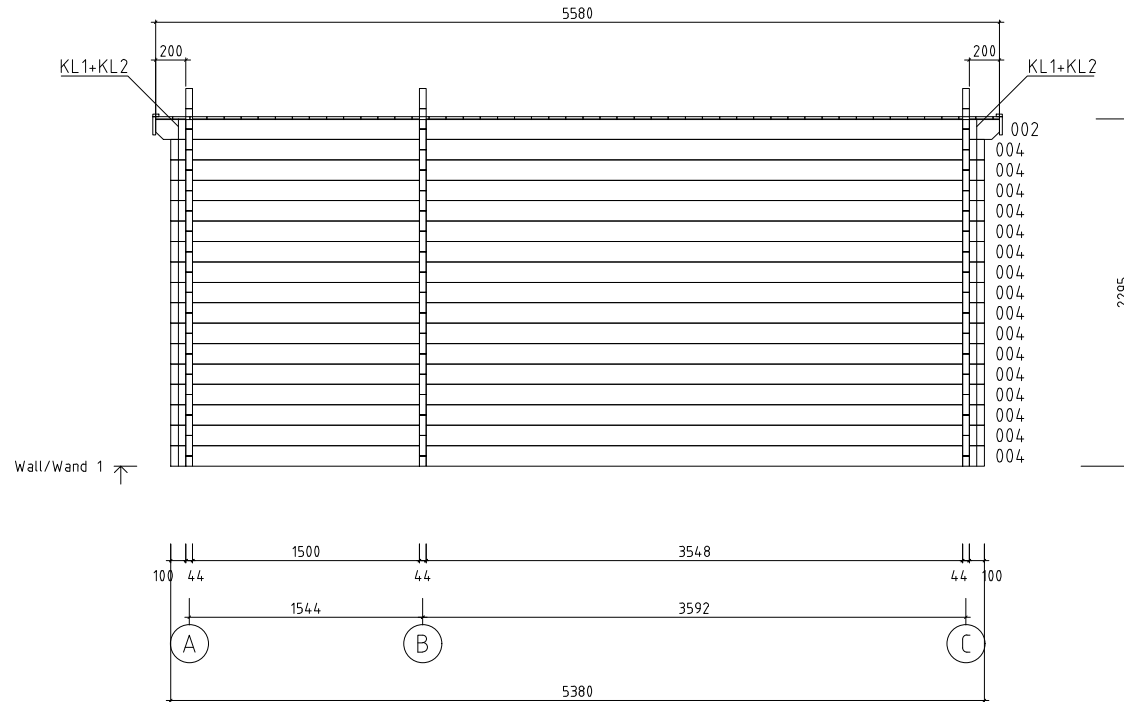
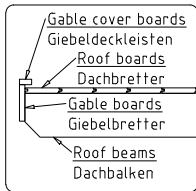

 www.hansa24.com	Name		Mia 1 328x538+VD 44	SKU	G0304	
	Drawing/Zeichnung			Wall/Wand 1	Format	A4
	Profile/Profil	4.4x13.5	Scale/Maßstab	1:50	Date	23.05.2023

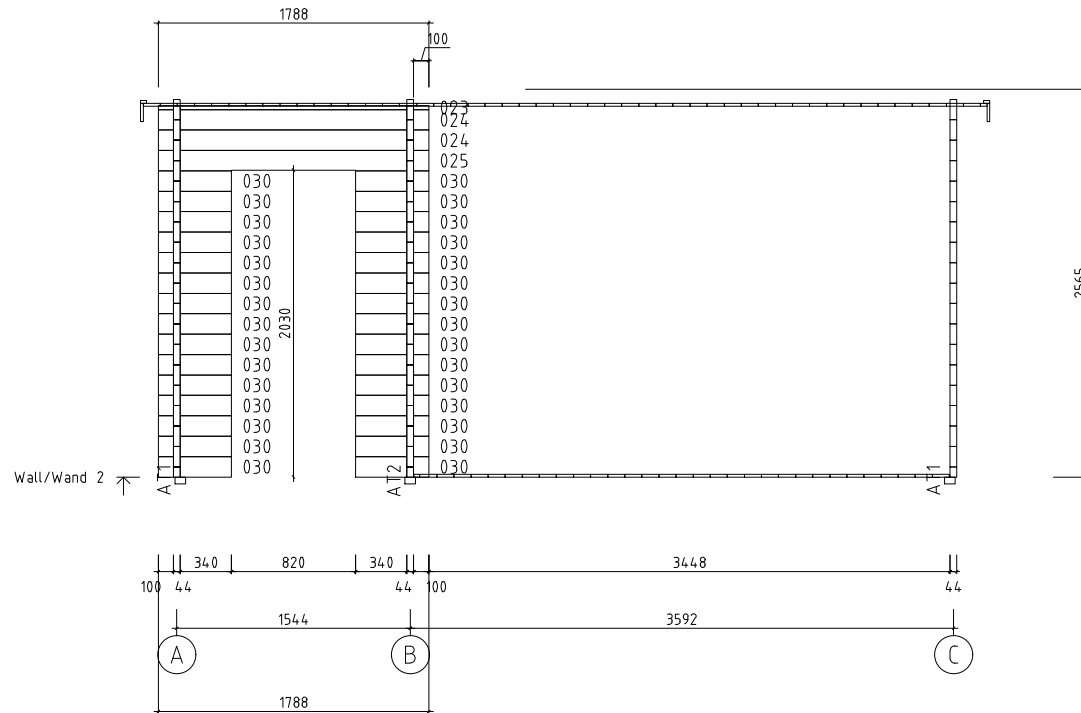

 www.hansa24.com	Name		Mia 1 328x538+VD 44	SKU	G0304	
	Drawing/Zeichnung			Wall/Wand 2	Format	A4
	Profile/Profil	4.4x13.5	Scale/Maßstab	1:50	Date	23.05.2023

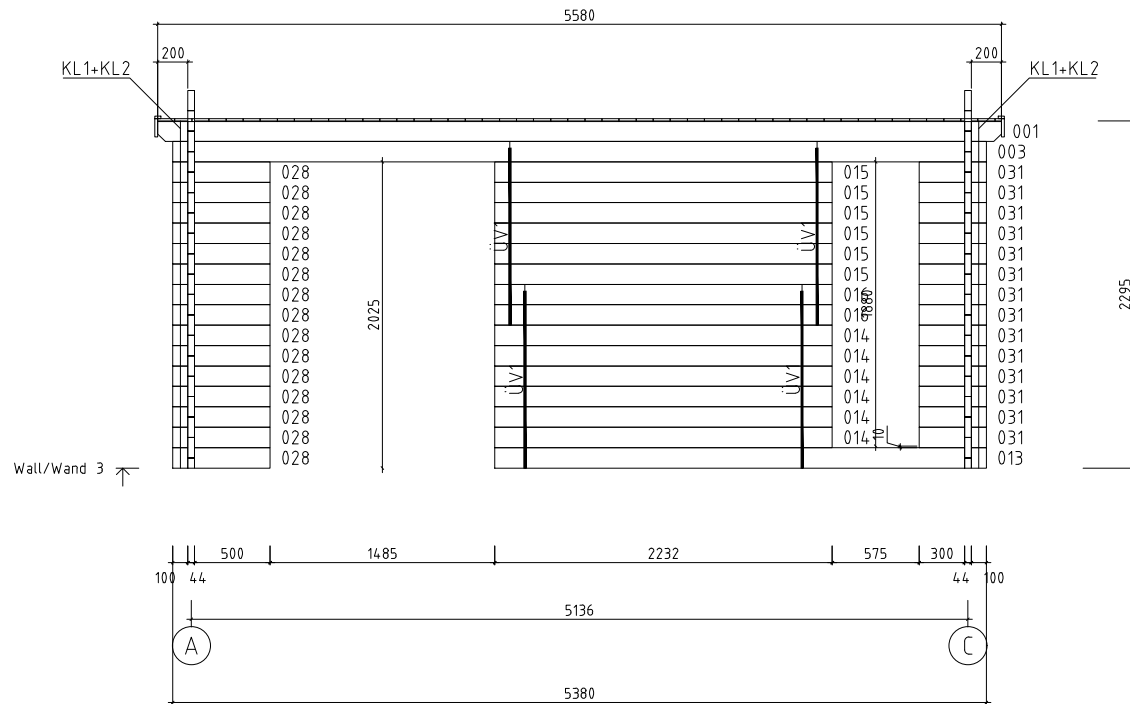

 www.hansa24.com	Name		Mia 1 328x538+VD 44	SKU	G0304
	Drawing/Zeichnung		Wall/Wand 3	Format	A4
	Profile/Profil	4.4x13.5	Scale/Maßstab	1:50	Date