

 www.hansa24.com	Name	Amelia 358x841.6 44	SKU	G0361
	Drawing/Zeichnung	3D		Format
	Profile/Profil	4.4x13.5	Scale/Maßstab	Date

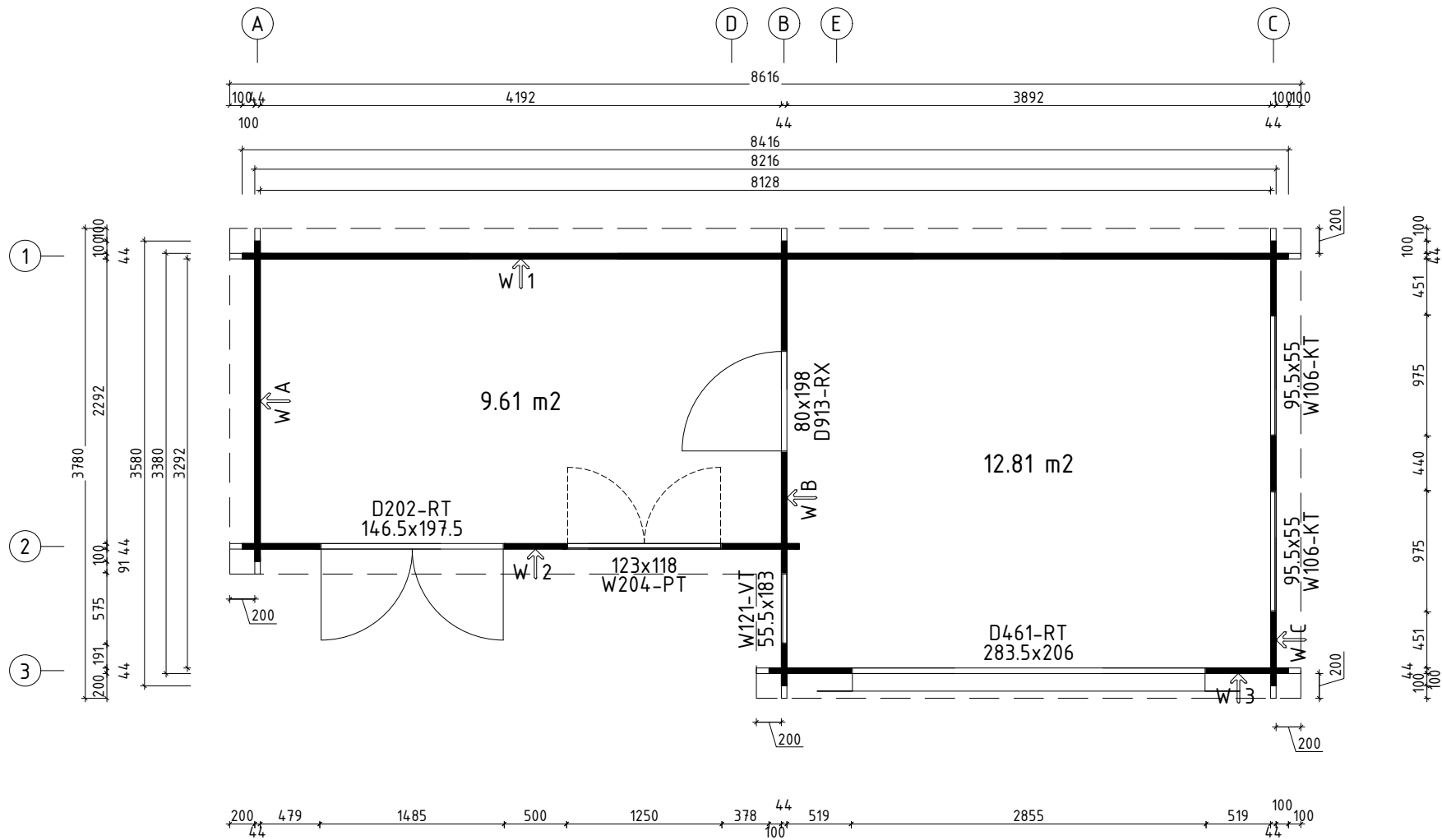

Name	Amelia 358x841.6 44	SKU	G0361
Drawing/Zeichnung	Plan_Grundplan	Format	A4
Profile/Profil	4.4x13.5	Scale/Maßstab	1:50
Date	20.06.2023		

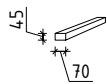

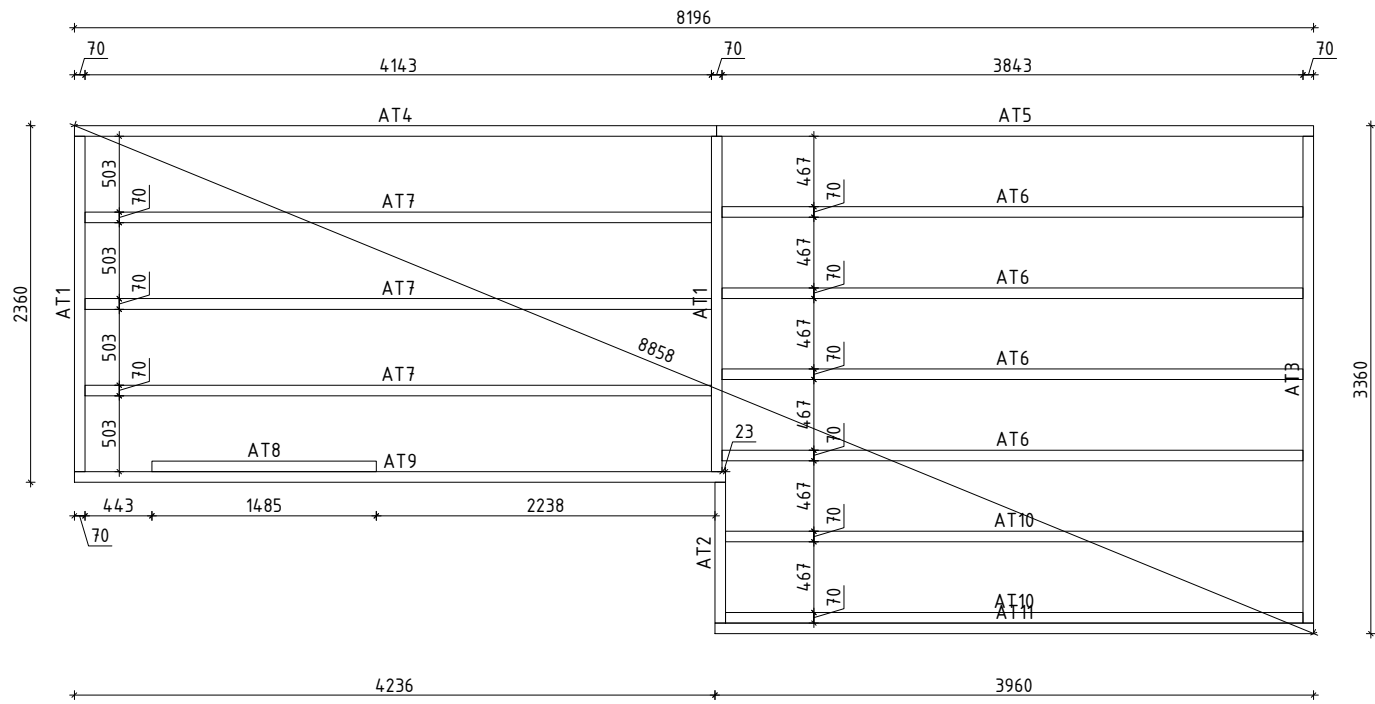

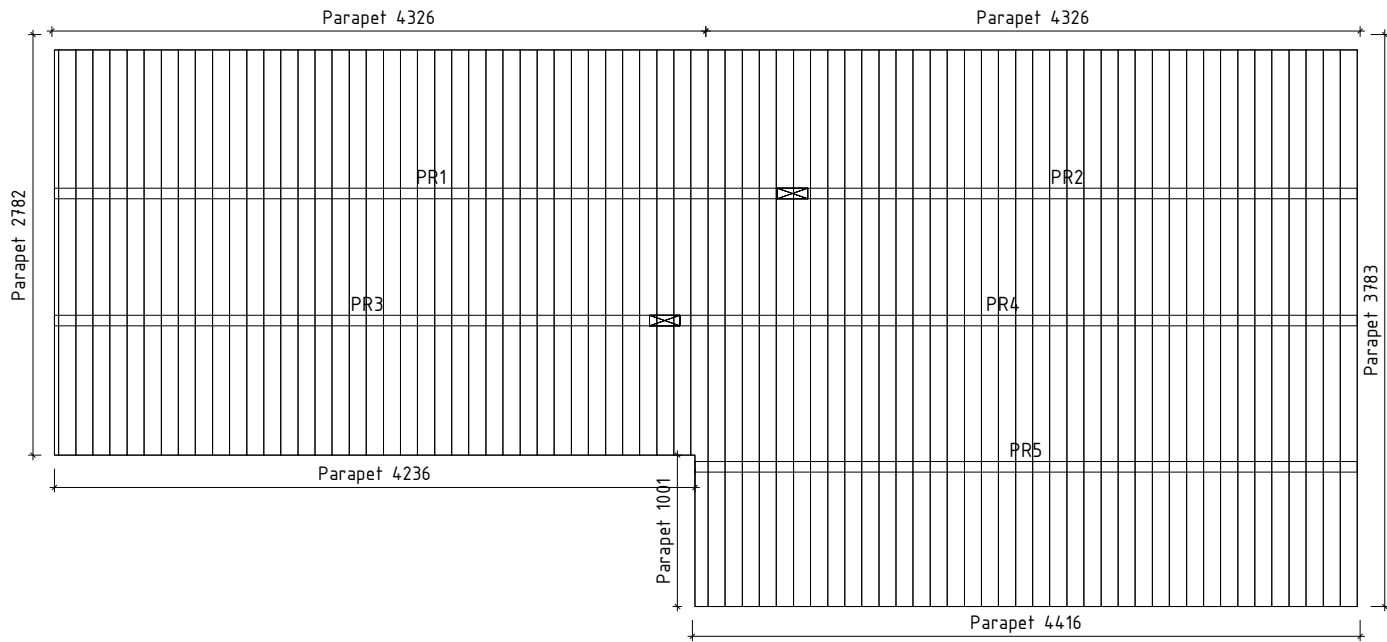





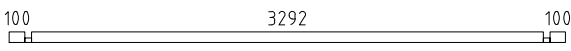

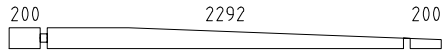
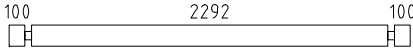
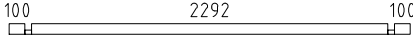
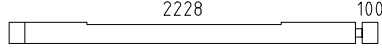
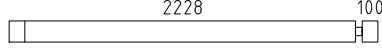
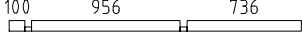

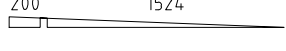
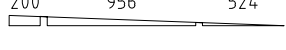
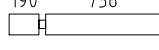
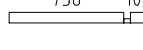
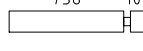
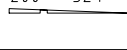
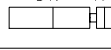
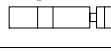
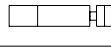















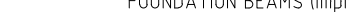

 www.hansa24.com	Name		Amelia 358x841.6 44		SKU		G0361
	Drawing/Zeichnung		Foundation plan_Lagerholzplan		Format		A4
	Profile/Profil	4.4x13.5	Scale/Maßstab	1:50	Date	20.06.2023	



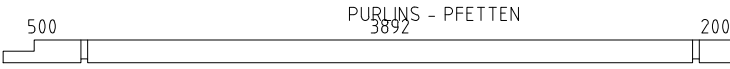
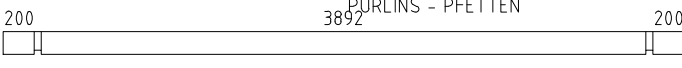
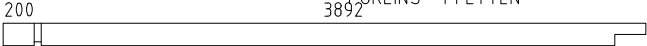
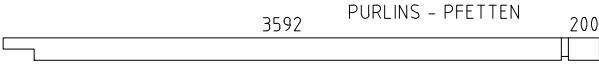

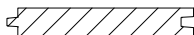
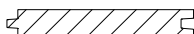
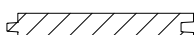





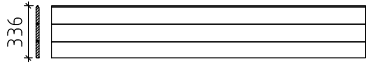
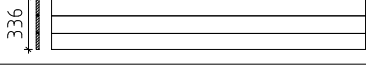
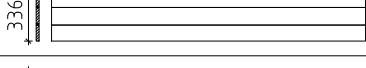
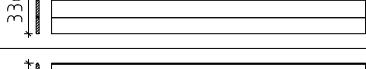
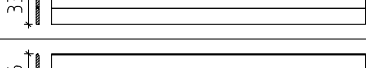
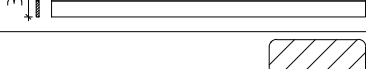
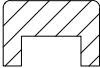

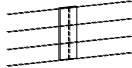

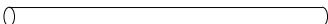

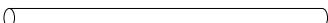

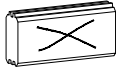











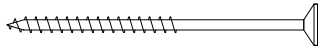

Name	Amelia 358x841.6 44	SKU	G0361
Drawing/Zeichnung	Roof Boards_Dachbretter	Format	A4
Profile/Profil	4.4x13.5	Scale/Maßstab	1:50
		Date	20.06.2023





Pos	Model Amelia 358x841.6 44	Pcs	Profile (mm)	Length (mm)
	Notice! The gable pieces can be partly pre-assembled! Please notice - those differ from the description given in the specification list.			
	Achtung! Die Giebelbohlen können teilweise schon vormontiert sein! Bitte beachten - diese erscheinen nicht ganz so wie in der Teilleiste beschrieben.			
004	100 4192 spare log/Ersatzteile 100 	1	44x135	4480
001	100 4192 210 	2	44x135	4590
002	200 4192 100 	1	44x89	4580
003	200 4192 100 	1	44x135	4580
004	100 4192 100 	1	44x135	4480
005	100 4192 100 	1	44x135	4480
006	200 4192 	1	44x135	4458
007	200 3892 200 	1	44x127	4380
008	100 4192 	5	44x135	4358
009	100 4192 	7	44x135	4358
010	210 3892 100 	3	44x135	4290
011	100 3892 100 	2	44x135	4180
012	100 3892 100 	1	44x135	4180
013	3892 200 	1	44x135	4158
014	100 4002 	3	44x135	4146
015	3892 100 	8	44x135	4058
016	3892 100 	4	44x135	4058
017	3702 100 	2	44x135	3846
018	200 3292 200 	1	44x135	3780
019	200 956 2292 200 	1	44x135	3780
020	100 3292 100 	11	44x135	3580
021	100 3292 100 	1	44x135	3580
022	100 3292 100 	1	44x135	3580
Kood	Amelia 358x841.6 44	Materjal	File	Leht 1/11



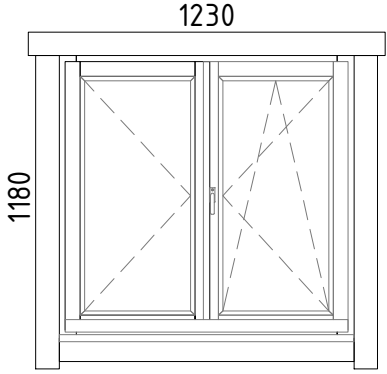

Pos	Model Amelia 358x841.6 44	Pcs	Profile (mm)	Length (mm)
023		1	44x68	3580
024		2	44x135	3580
025		1	44x135	3580
026		1	44x135	2780
027		17	44x135	2580
028		1	44x68	2580
029		1	44x135	2372
030		5	44x135	2372
031		1	44x68	1880
032		1	44x135	1880
033		1	44x68	1768
034		1	44x68	1768
035		13	44x135	970
036		1	44x68	880
037		14	44x135	880
038		1	44x29	768
039		14	44x135	663
040		4	44x135	663
041		12	44x135	663
042		15	44x135	623
043		9	44x135	622
044		8	44x135	595
045		1	44x135	500
046		2	44x135	500
047		6	44x135	500
Kood	Amelia 358x841.6 44	Materjal	File	Leht 2/11



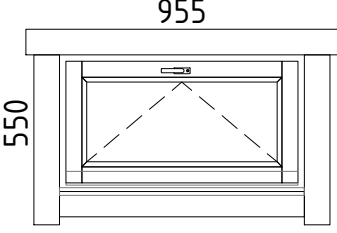

Pos	Model Amelia 358x841.6 44	Pcs	Profile (mm)	Length (mm)
048	FOUNDATION BEAMS (impregnated) - FUNDAMENTHÖLZER (imprägniert) 	4	44x135	440
049	100 191 	13	44x135	335
AT9	FOUNDATION BEAMS (impregnated) - FUNDAMENTHÖLZER (imprägniert) 	1	70x45	4306
AT4		1	70x45	4248
AT7	FOUNDATION BEAMS (impregnated) - FUNDAMENTHÖLZER (imprägniert) 	3	70x45	4143
AT11	FOUNDATION BEAMS (impregnated) - FUNDAMENTHÖLZER (imprägniert) 	1	70x45	3960
AT5	FOUNDATION BEAMS (impregnated) - FUNDAMENTHÖLZER (imprägniert) 	1	70x45	3948
AT6	FOUNDATION BEAMS (impregnated) - FUNDAMENTHÖLZER (imprägniert) 	4	70x45	3843
AT10	FOUNDATION BEAMS (impregnated) - FUNDAMENTHÖLZER (imprägniert) 	2	70x45	3820
AT3	FOUNDATION BEAMS (impregnated) - FUNDAMENTHÖLZER (imprägniert) 	1	70x45	3220
AT1	FOUNDATION BEAMS (impregnated) - FUNDAMENTHÖLZER (imprägniert) 	2	70x45	2220
AT8	FOUNDATION BEAMS (impregnated) - FUNDAMENTHÖLZER (imprägniert) 	1	70x45	1485
AT2	FOUNDATION BEAMS (impregnated) - FUNDAMENTHÖLZER (imprägniert) 	1	70x45	930
PR1	PURLINS - PFETTEN 200 4192 500 	1	70x145	4980
PR4	PURLINS - PFETTEN 500 3892 200 	1	70x145	4680
PR5	PURLINS - PFETTEN 200 3892 200 	1	70x145	4380
PR3	PURLINS - PFETTEN 200 3892 	1	70x145	4136
PR2	PURLINS - PFETTEN 3592 200 	1	70x145	3836
	ROOF BOARDS - DACHBRETTER 	39+1	113x18	3683
	ROOF BOARDS - DACHBRETTER 	38	113x18	2682
	FLOOR BOARDS - FUSSBODENBRETTER 	35+1	113x18	3287
	FLOOR BOARDS - FUSSBODENBRETTER 	38	113x18	2287
	Ceiling mouldings - Deckenleisten (inside and outside - innen und außen) 		15x28	52 rm/lfm
	Floor mouldings - Fussbodenleisten 		18x40	29 rm/lfm
RLI01-1	Eave slat - Traufenleiste 18x40 		18x40	17.83 rm/lfm
Kood	Amelia 358x841.6 44	Materjal	File	Leht 3/11



Pos	Model Amelia 358x841.6 44	Pcs	Profile (mm)	Length (mm)
KAR1-1	Parapet - Blende 336 	1	18x336	1001
KAR1-2	Parapet - Blende 336 	1	18x336	2782
KAR1-3	Parapet - Blende 336 	1	18x336	3783
KAR1-4	Parapet - Blende 336 	1	18x336	4236
KAR1-5	Parapet - Blende 336 	2	18x336	4326
KAR1-6	Parapet - Blende 336 	1	18x336	4416
KAR2-1	Parapet cover - U-Profil für Blenden 		44x65	25.8 cm/lfm
KAR3-1	Parapet support - Blendestütze 44x65 	14	44x65	200
KAR4-1	Parapet- connecting slat - Blende- Verbindungsleiste 	1	18x120	330
ÜV1	Metal bar - Metallstange Ø10 	6	Ø10	1170
ÜV2	Metal bar - Metallstange Ø10 	4	Ø10	900
ÜV3	Metal bar - Metallstange Ø10 	1	Ø10	770
ÜV4	Metal bar - Metallstange Ø10 	2	Ø10	500
ÜV5	Metal bar - Metallstange Ø10 	5	Ø10	360
ML01	Connecting strip for wall logs - Verbindungsstreifen für Wandbalken 	13		
LK	Hit block - Schlaghölzer 	3		
N-0 2503	Nails - Nägel 2.5x60 for floor boards - für Fussbodenbretter 	870		
N-0 2501	Nails - Nägel vierkant 2.5x50 for ceiling boards - für Dachbretter 	770		
KR-0 3001	Screws - Schrauben 3.0x30 for ceiling mouldings - für Deckenleisten 	108		
KR-0 3002	Screws - Schrauben 3.0x30 for eave slats - für Traufenleisten 	38		
KR-0 3003	Screws - Schrauben 3.0x30 for floor mouldings - für Fussbodenleisten 	56		
KR-0 3004	Screws - Schrauben 3.0x30 for parapet connecting slat - für Verbindungsleiste des Blendes 	8		
KR-0 3522	Screws - Schrauben 3.5x45 C3 for connecting strip for wall logs - für Verbindungsstreifen für Wandbalken 	52		
KR-0 3529	Screws - Schrauben 3.5x45 C3 for U-profile - für U-Profil 	56		
KR-0 5080	Screws - Schrauben 5.0x100 for foundation beams - für Fundamenthölzer 	72		
Kood	Amelia 358x841.6 44	Materjal	File	Leht 4/11

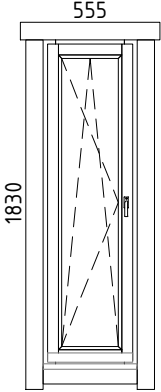



Pos	Model Amelia 358x841.6 44		Pcs	Profile (mm)	Length (mm)
KR-0 5081	Screws - Schrauben 5.0x100 for parapet supports - für Blendestützen		28		
KR-0 5031	Screws - Schrauben 5.0x70 C3 for parapet fastening - für Blendenbefestigung		62		
KL1	Threaded rod - Gewindestange M8		5		2000
KL2	Threaded rod - Gewindestange M8		2		587
KL3	Threaded rod - Gewindestange M8		1		549
KL4	Threaded rod - Gewindestange M8		2		460
KL03-1	Threaded rod for purlins - Gewindestange für die Pfetten M12		4		150
M03	Nut for purlins - Mutter für die Pfetten M12		8		
SE32	Washer for purlins - Scheibe für die Pfetten M12x37		8		
	Nut - Mutter M8		5		
	Washer - Scheibe M8x24		5		
	Extended nut - Langmutter M8		5		
	Drive-in nut - Einschlagmutter M8		5		
Kood	Amelia 358x841.6 44	Materjal	File	Leht	5/11

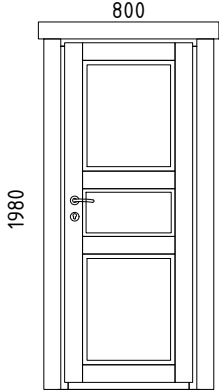

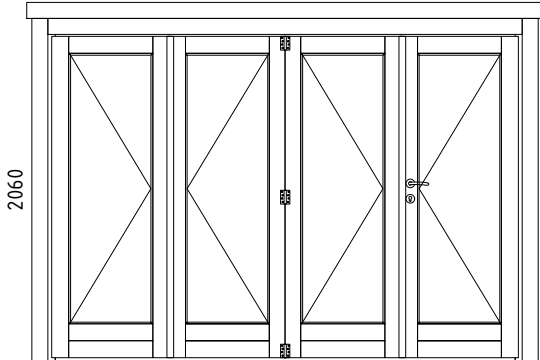

Pos	Model Amelia 358x841.6 44	Pcs	Profile (mm)	Length (mm)
	WINDOW 1230x1180 W5-D44P-0XT-12301180  <u>W204-PT</u> Right handed - DIN rechts Tempered glass - Gehärtetes Glas Opens inside - Öffnet innen	1		
VIHM 01-1	Rain deflector - Regenabweiser	 1	36x134	1430
KR-0 3524	Screws - Schrauben 3.5x45 C3 for door and window trims - für Tür- und Fensterleisten	 28		
KR-0 4001	Screws - Schrauben 4.0x60 C3 for rain deflector - für Regenabweiser	 5		
Kood Amelia 358x841.6 44	Materjal	File	Leht 6/11	

Pos	Model Amelia 358x841.6 44	Pcs	Profile (mm)	Length (mm)
	WINDOW 955x550 W5-S44K-0XT-09550550  W106-KT Tempered glass - Gehärtetes Glas Opens inside - Öffnet innen	2		
VIHM 01-2	Rain deflector - Regenabweiser 	2	36x134	1155
KR-0 3524	Screws - Schrauben 3.5x45 C3 for door and window trims - für Tür- und Fensterleisten 	40		
KR-0 4001	Screws - Schrauben 4.0x60 C3 for rain deflector - für Regenabweiser 	6		
Kood	Amelia 358x841.6 44	Materjal	File	Leht 7/11

Pos	Model Amelia 358x841.6 44	Pcs	Profile (mm)	Length (mm)
	WINDOW 555x1830 W5-S44V-0XT-05551830  W121-VT Left handed - DIN links Tempered glass - Gehärtetes Glas Opens inside - Öffnet innen	1		
VIHM 01-3	Rain deflector - Regenabweiser	 1	36x134	755
KR-0 3524	Screws - Schrauben 3.5x45 C3 for door and window trims - für Tür- und Fensterleisten	 24		
KR-0 4001	Screws - Schrauben 4.0x60 C3 for rain deflector - für Regenabweiser	 2		
Kood	Amelia 358x841.6 44	Materjal	File	Leht 8/11

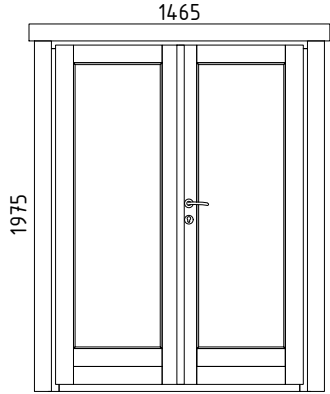
Pos	Model Amelia 358x841.6 44	Pcs	Profile (mm)	Length (mm)
	DOOR 800x1980 D0-I44R-XXX-08001980  D913-RX Right handed - DIN rechts Opens outside - Öffnet aussen	1		
KR-0 3524	Screws - Schrauben 3.5x45 C3 for door and window trims - für Tur- und Fensterleisten 	26		
Kood Amelia 358x841.6 44	Materjal	File	Leht	9/11

Pos	Model Amelia 358x841.6 44	Pcs	Profile (mm)	Length (mm)	
	DOOR 2835x2060 D4-F44R-0XT-28352060  2835 2060 D461-RT Right handed - DIN rechts Tempered glass - Gehärtetes Glas Opens outside - Öffnet aussen	1			
VIHM 01-4	Rain deflector - Regenabweiser		1	36x134	3035
KR-0 3524	Screws - Schrauben 3.5x45 C3 for door and window trims - für Tür- und Fensterleisten		38		
KR-0 4001	Screws - Schrauben 4.0x60 C3 for rain deflector - für Regenabweiser		7		
Kood	Amelia 358x841.6 44	Materjal	File	Leht	10/11

Pos	Model Amelia 358x841.6 44	Pcs	Profile (mm)	Length (mm)
	D00R 1465x1975 D5-D44R-0XT-14651975  D202-RT Right handed - DIN rechts Tempered glass - Gehärtetes Glas Opens outside - Öffnet aussen	1		
VIHM 01-5	Rain deflector - Regenabweiser		36x134	1665
KR-0 3524	Screws - Schrauben 3.5x45 C3 for door and window trims - für Tür- und Fensterleisten		28	
KR-0 4001	Screws - Schrauben 4.0x60 C3 for rain deflector - für Regenabweiser		4	
Kood Amelia 358x841.6 44	Materjal	File	Leht 11/11	

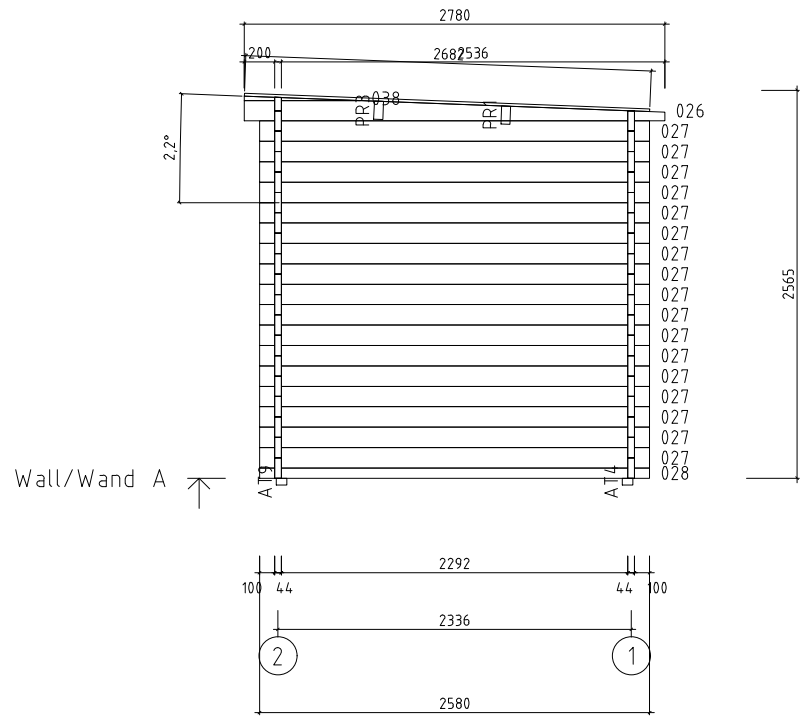

 www.hansa24.com	Name		Amelia 358x841.6 44		SKU		G0361
	Drawing/Zeichnung		Wall/Wand A		Format		A4
	Profile/Profil	4.4x13.5	Scale/Maßstab	1:50	Date	20.06.2023	

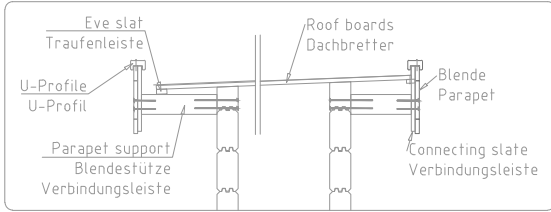

Wall/Wand B ↗

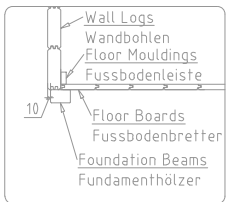
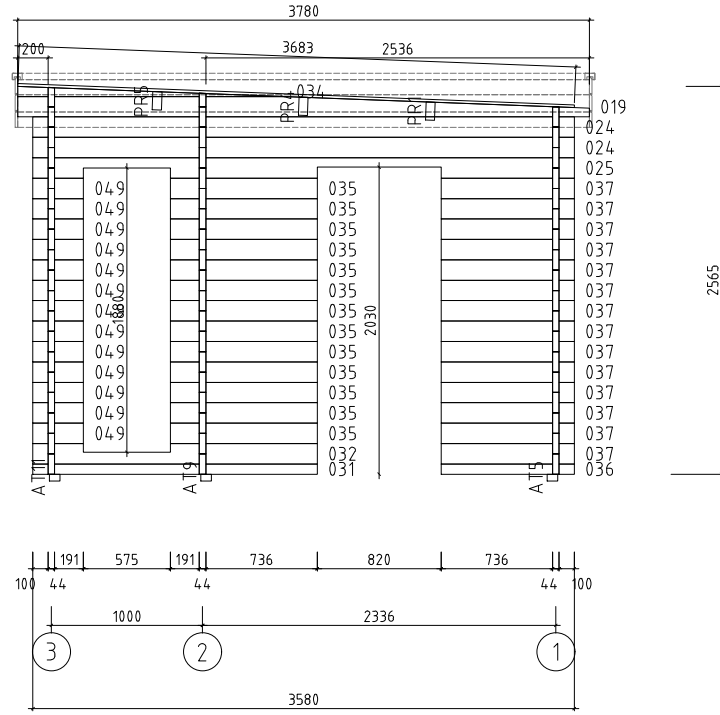

Name	Amelia 358x841.6 44		SKU	G0361	
Drawing/Zeichnung	Wall/Wand B		Format	A4	
Profile/Profil	4.4x13.5	Scale/Maßstab	1:50	Date	20.06.2023

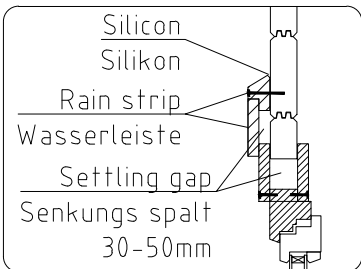
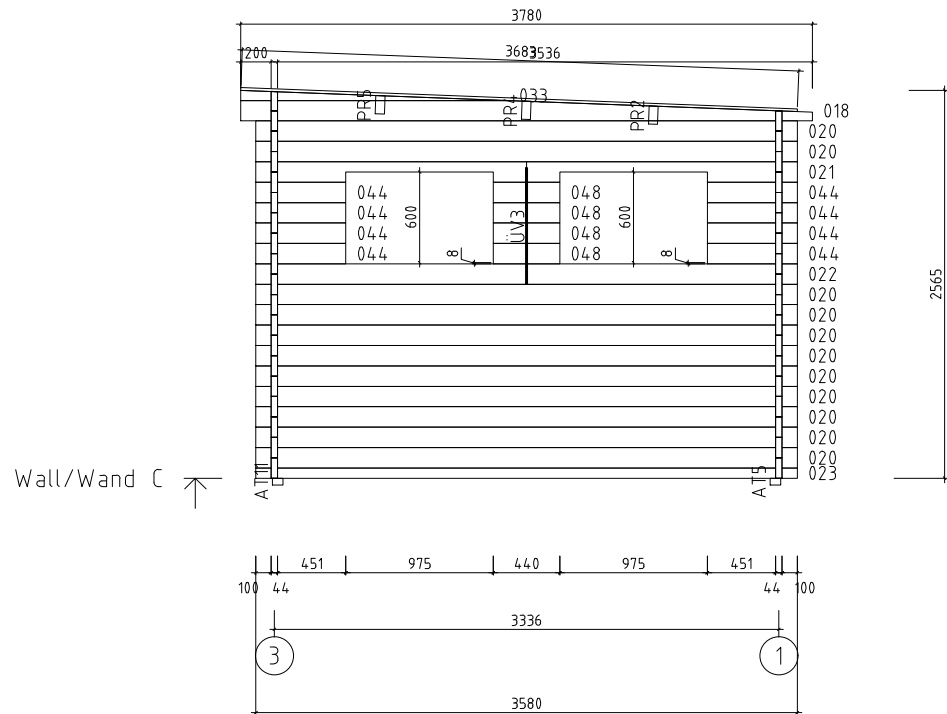

 www.hansa24.com	Name		Amelia 358x841.6 44		SKU	G0361
	Drawing/Zeichnung		Wall/Wand C		Format	A4
	Profile/Profil	4.4x13.5	Scale/Maßstab	1:50	Date	20.06.2023

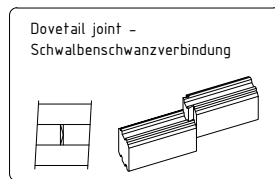
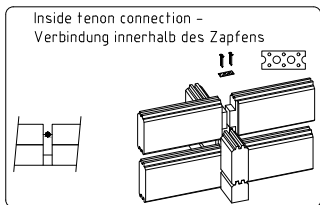
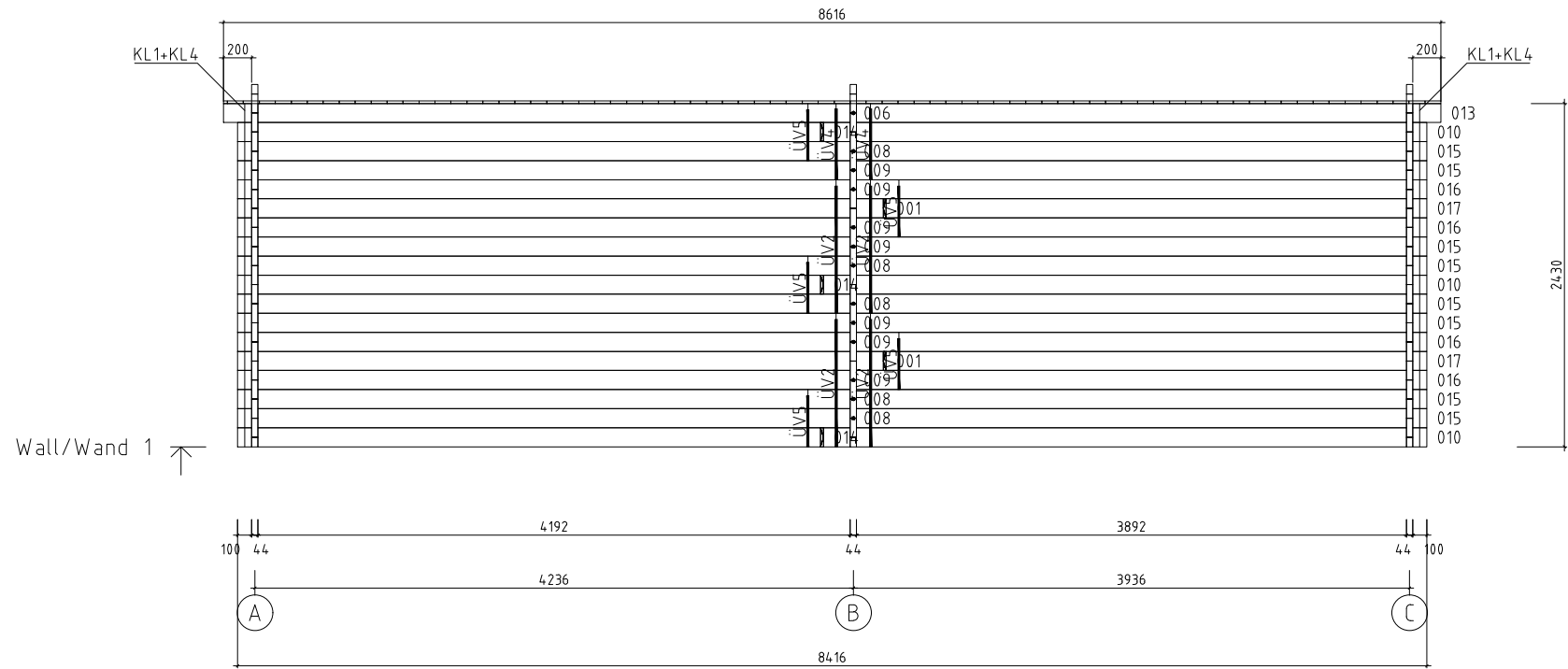

 www.hansa24.com	Name Amelia 358x841.6 44		SKU G0361
	Drawing/Zeichnung Wall/Wand 1		Format A4
Profile/Profil 4.4x13.5	Scale/Maßstab 1:50	Date 20.06.2023	

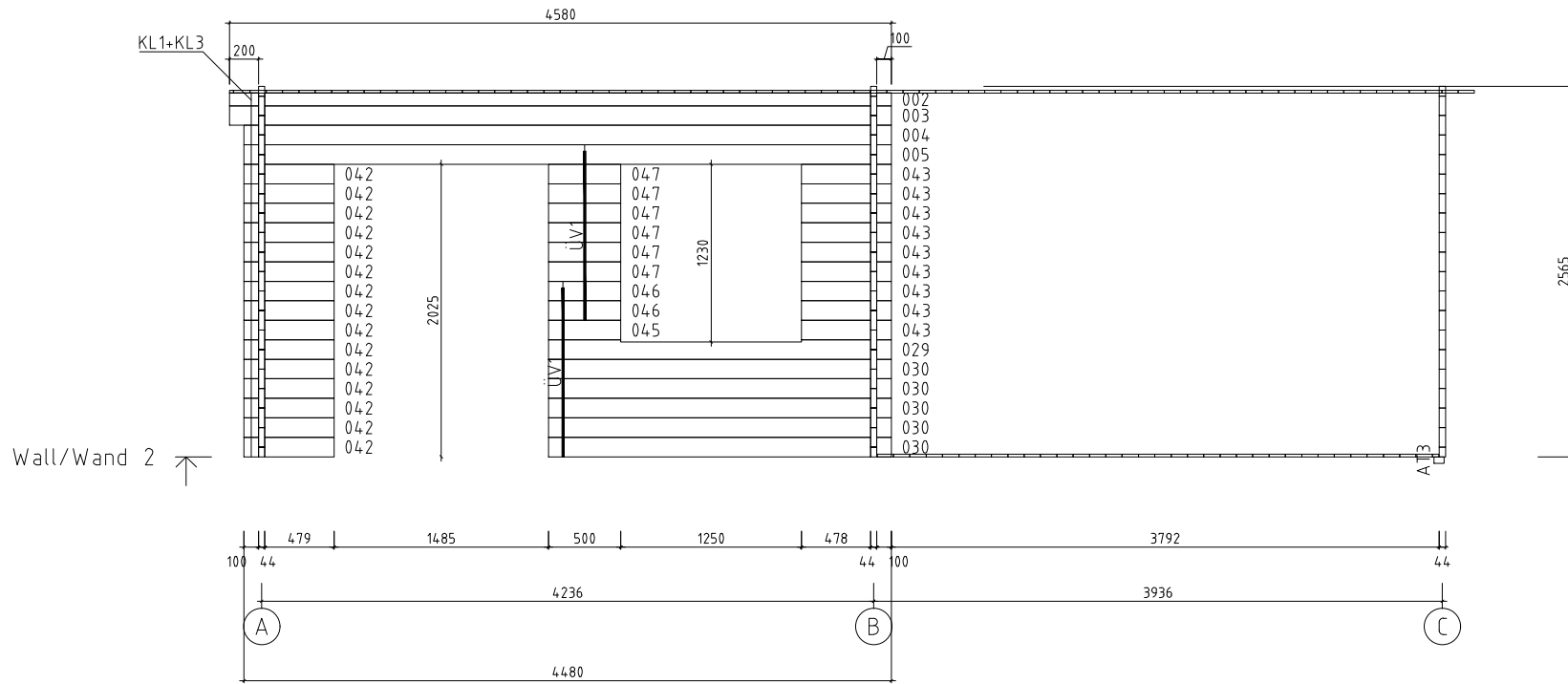

Name	Amelia 358x841.6 44	SKU	G0361
Drawing/Zeichnung	Wall/Wand 2	Format	A4
Profile/Profil	4.4x13.5	Scale/Maßstab	1:50
		Date	20.06.2023

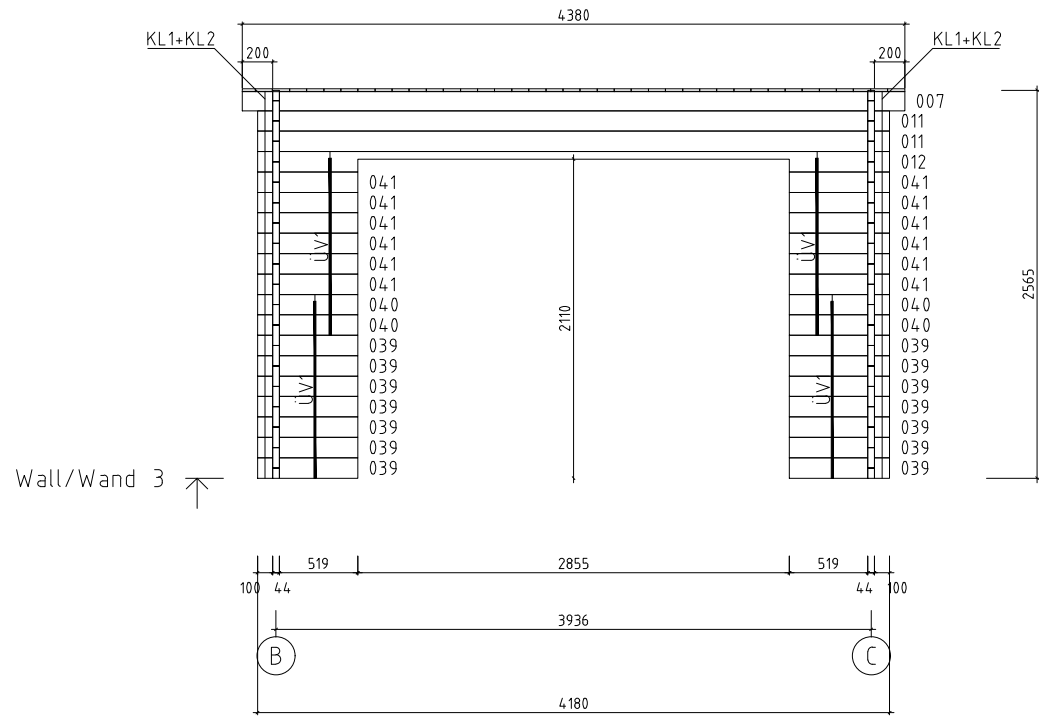

Name	Amelia 358x841.6 44		SKU	G0361	
Drawing/Zeichnung	Wall/Wand 3		Format	A4	
Profile/Profil	4.4x13.5	Scale/Maßstab	1:50	Date	20.06.2023