

Das Haus lässt sich auch spiegeverkehrt aufbauen.

Cabin can be built mirrored.

Name	Hansa Corner Sauna A 700x360+SD+Terr 70		
Zeichnung/Drawing	3D		
Profil/Profile	7x13.5	Datum/Date	03.03.2023

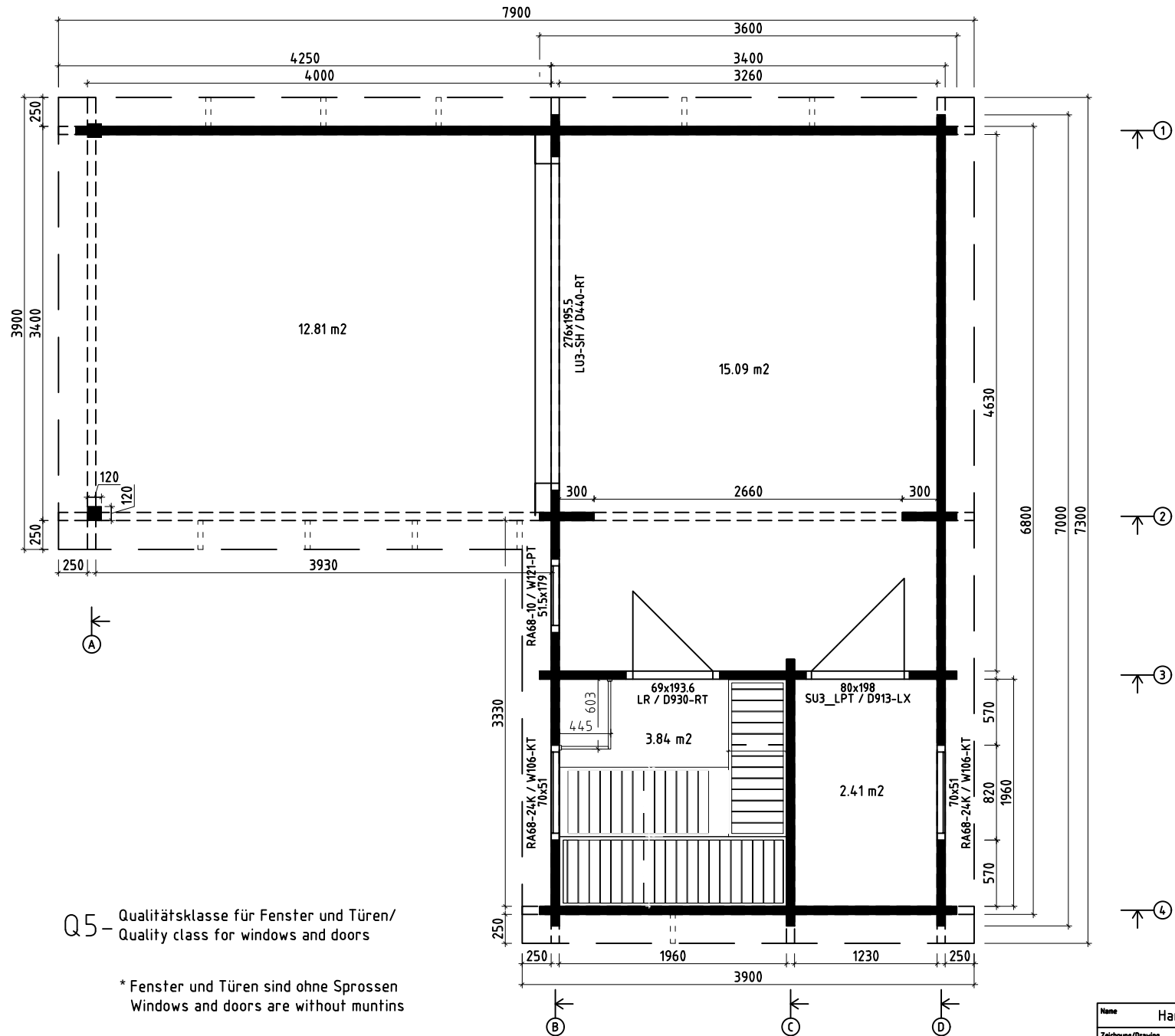

Q5 - Qualitätsklasse für Fenster und Türen/
 Quality class for windows and doors





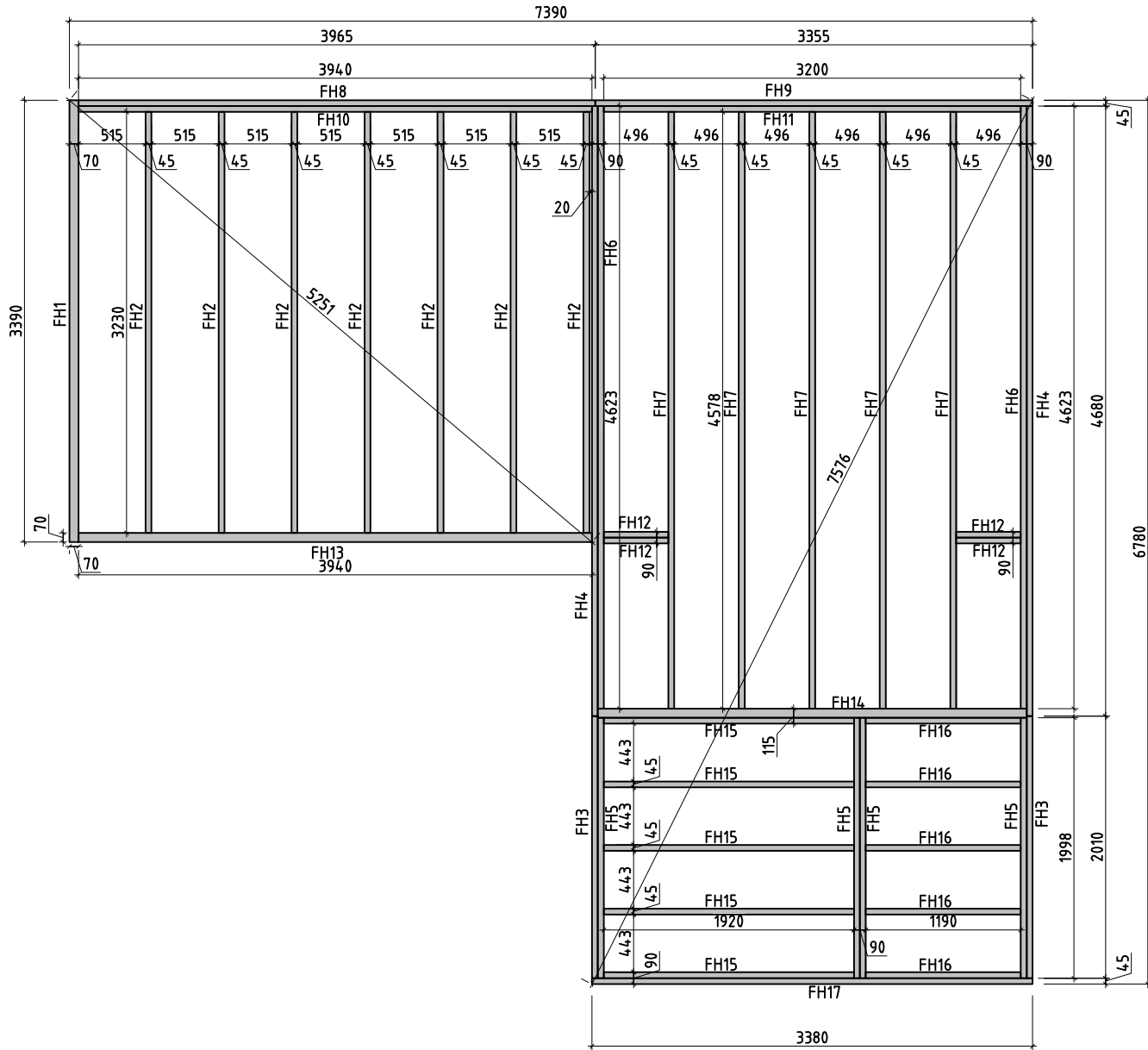



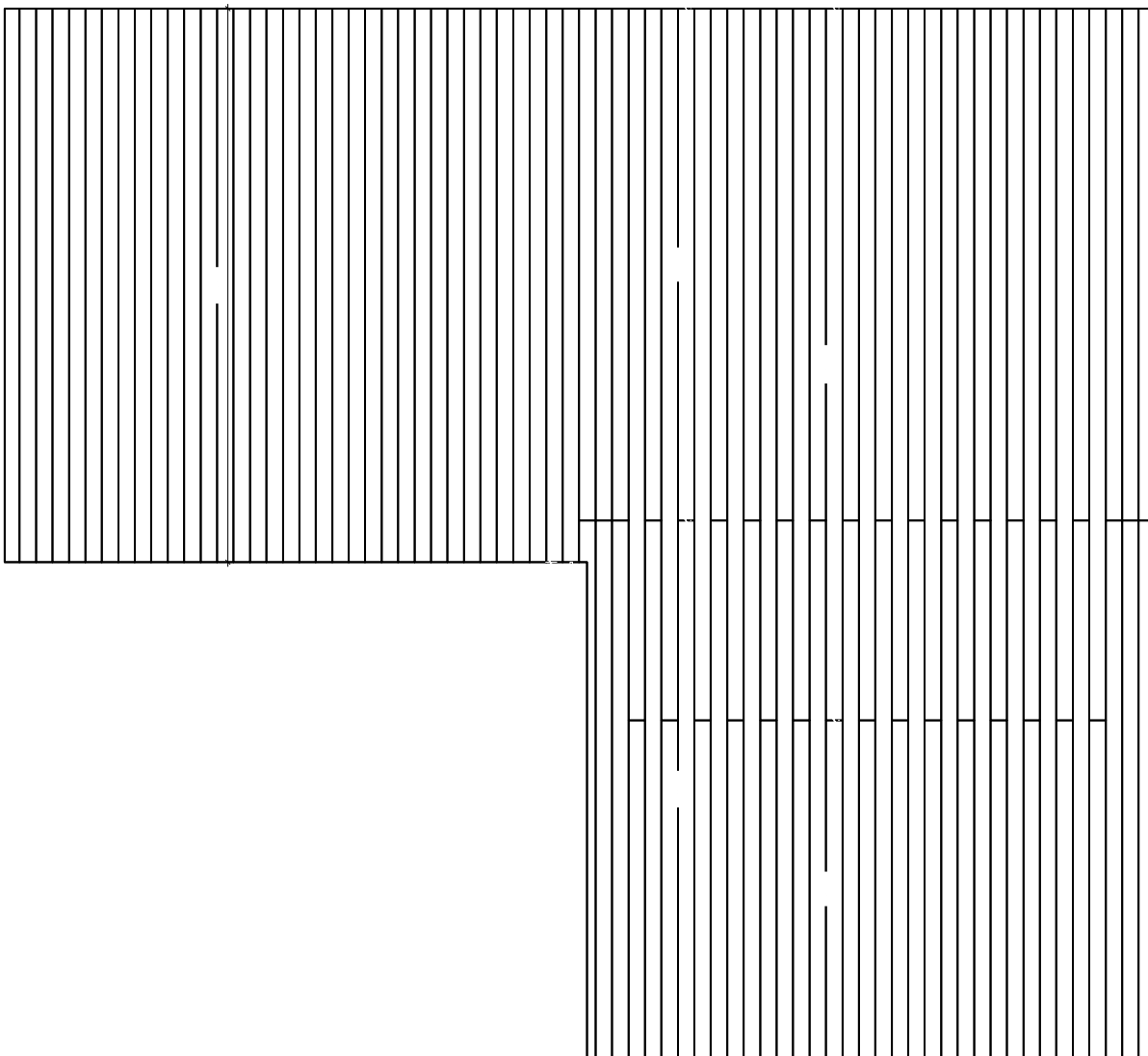

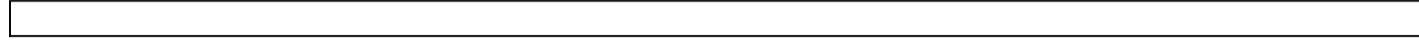
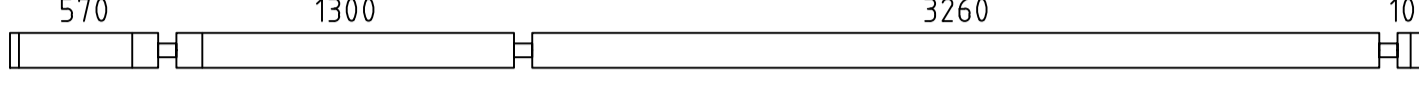
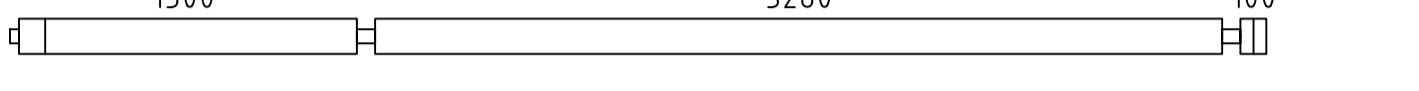
* Fenster und Türen sind ohne Sprossen
 Windows and doors are without muntins

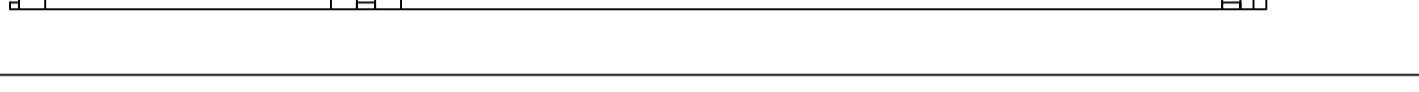
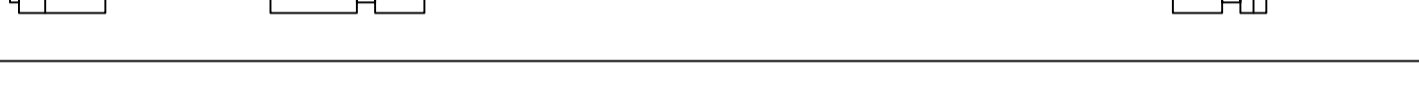

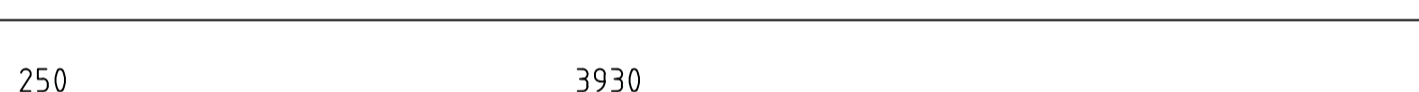
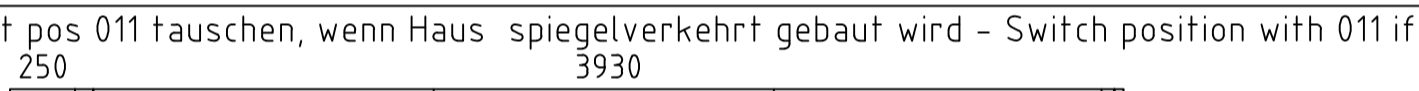

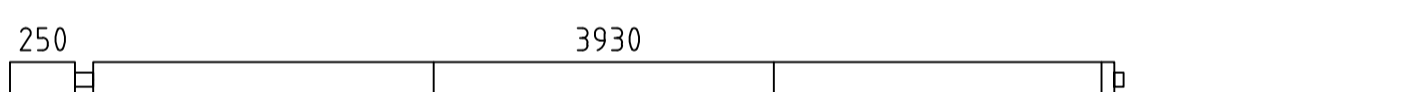
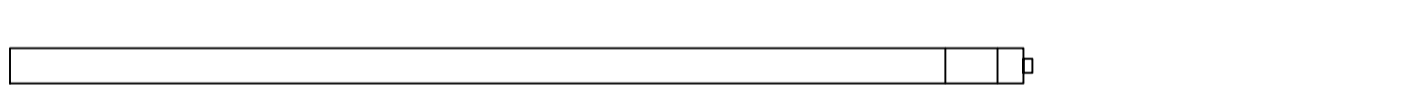
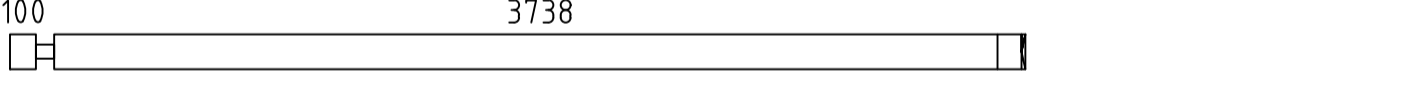
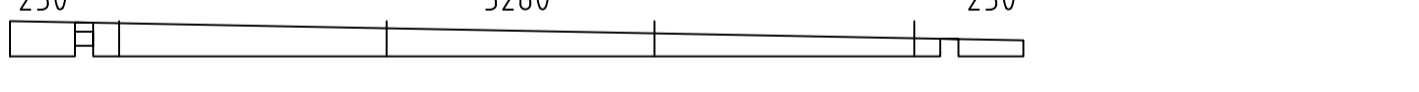
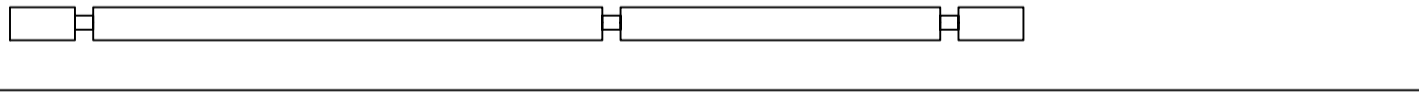
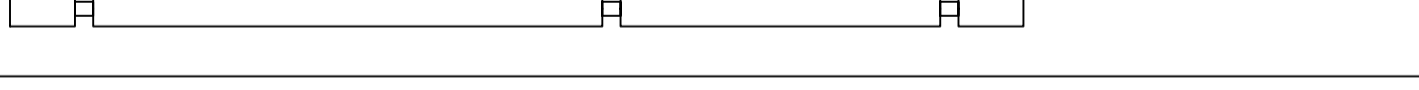
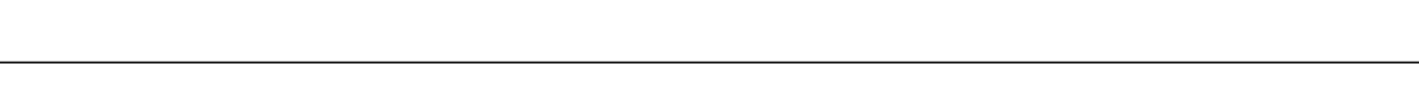

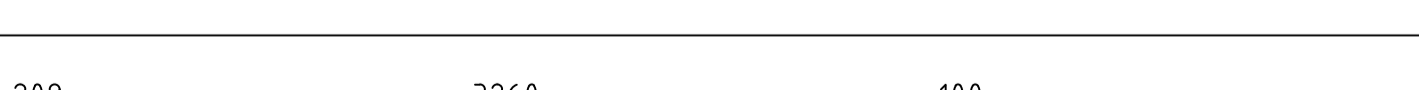
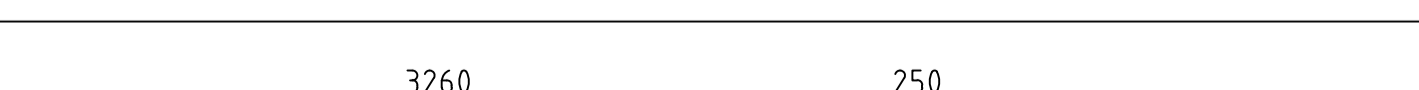

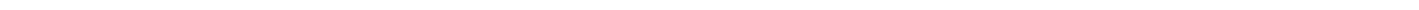
Name	Hansa Corner Sauna A 700x360+SD+Terr 70		
Zeichnung/Drawing	Grundplan, Plan		
Profil/Profile	7x13.5	Datum/Date	03.03.2023

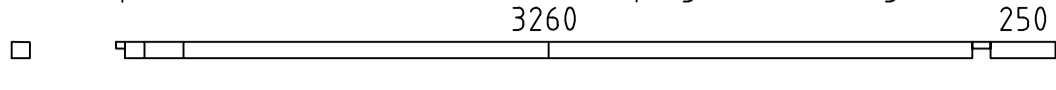
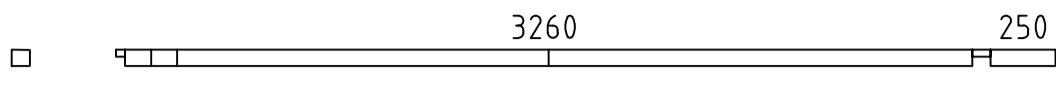
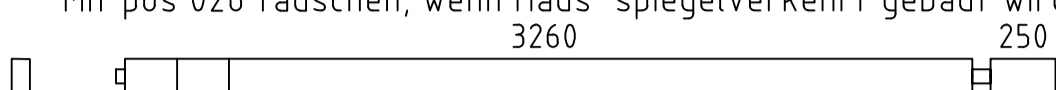
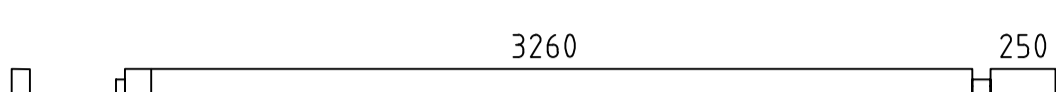

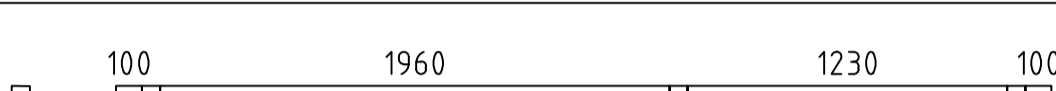

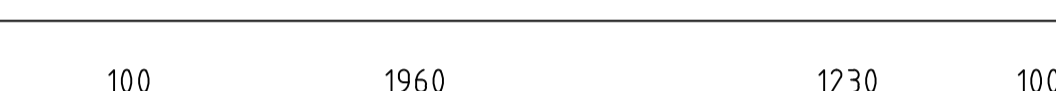
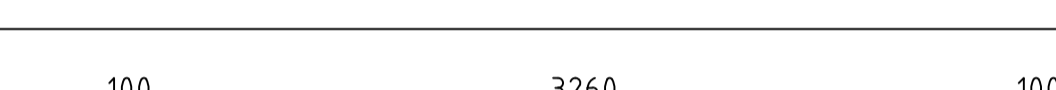
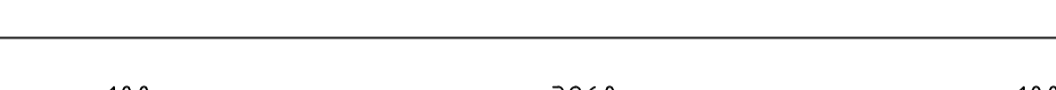

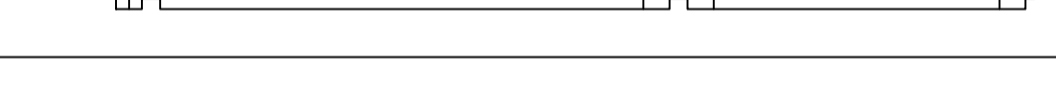
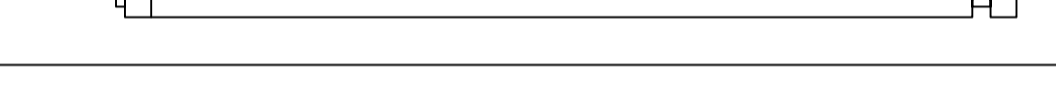
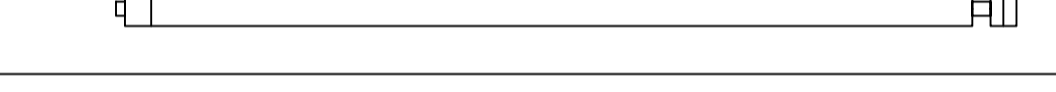
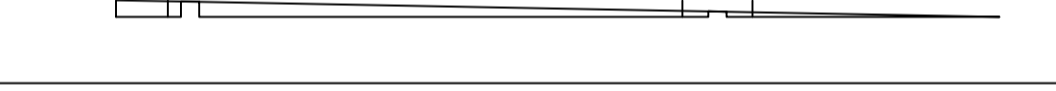
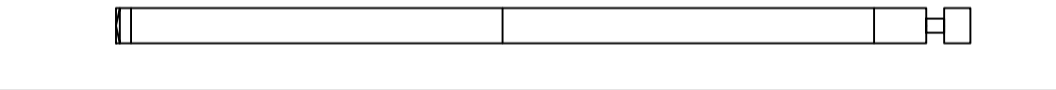
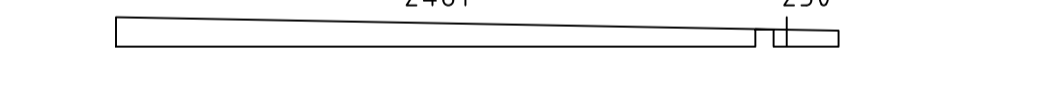
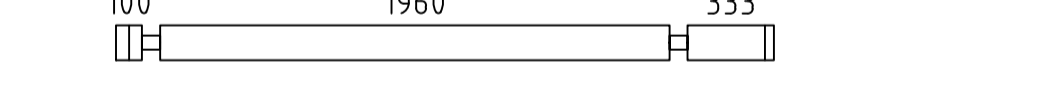
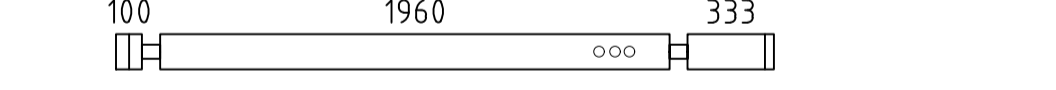
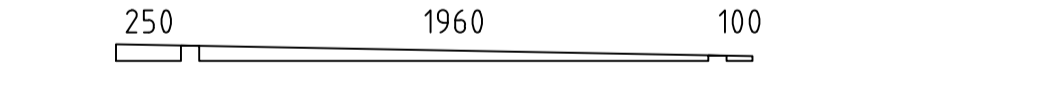
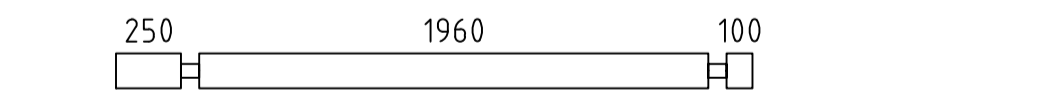
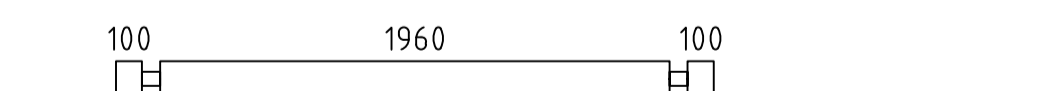
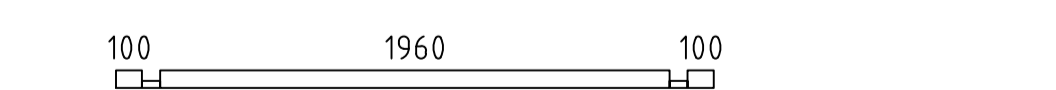



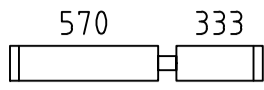
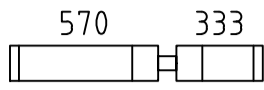
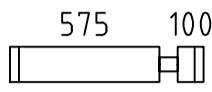
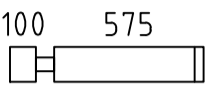
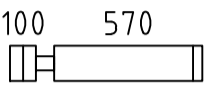
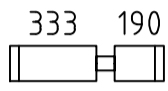
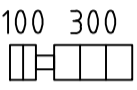
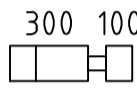
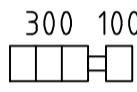
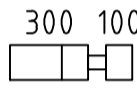
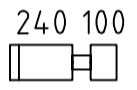
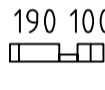
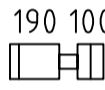
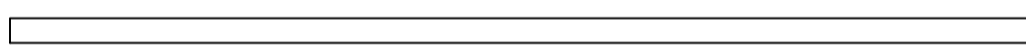
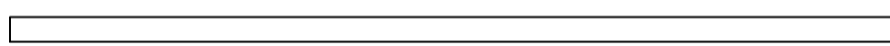
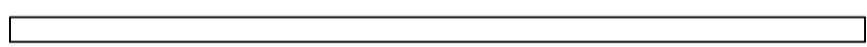
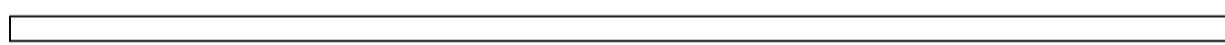
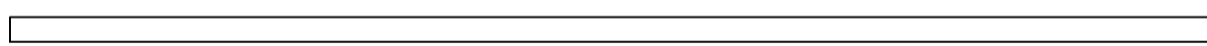
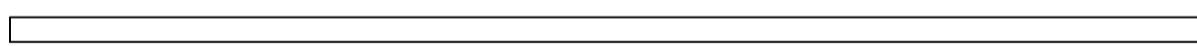
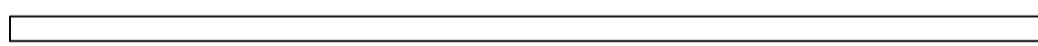
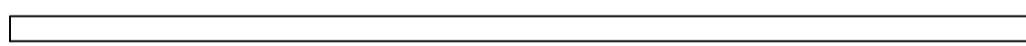
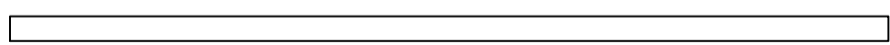
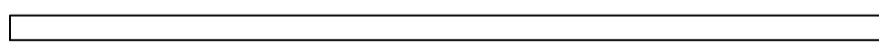
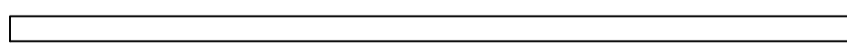
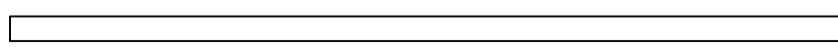

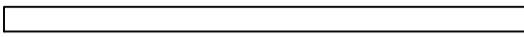
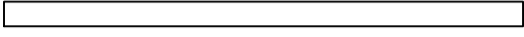
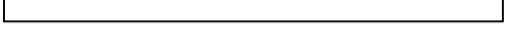
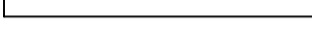
Name	Hansa Corner Sauna A 700x360+SD+Terr 70	
Zeichnung/Drawing	Lagerholzplan , Foundation plan	
Profil/Profile	7x13.5	Datum/Date 03.03.2023

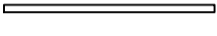
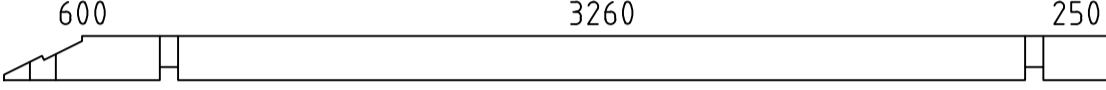
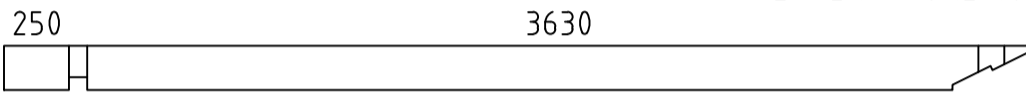
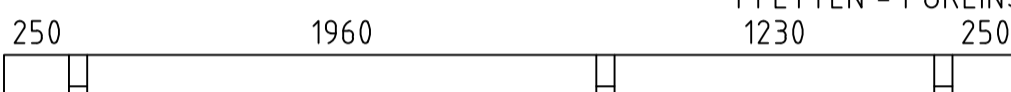
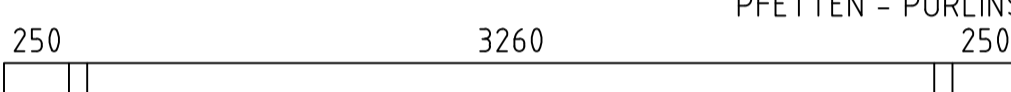



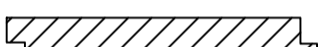
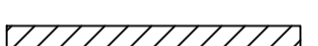
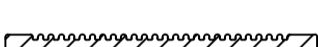



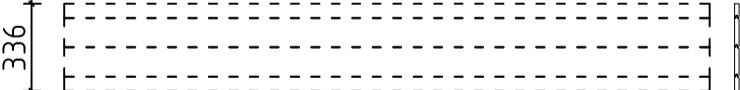
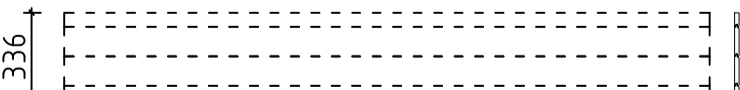
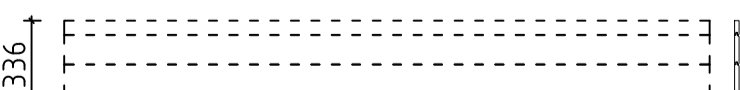
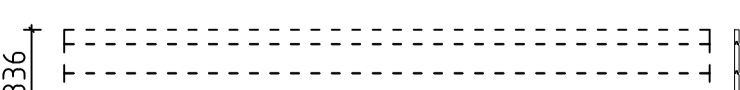
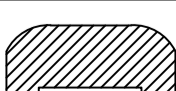

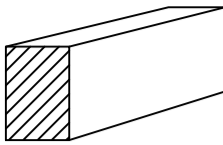
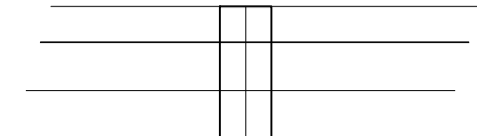
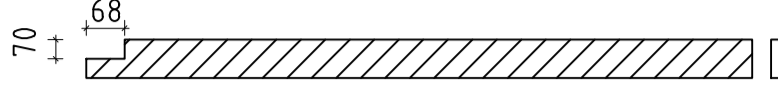
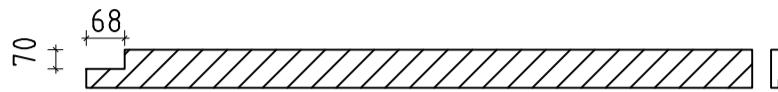



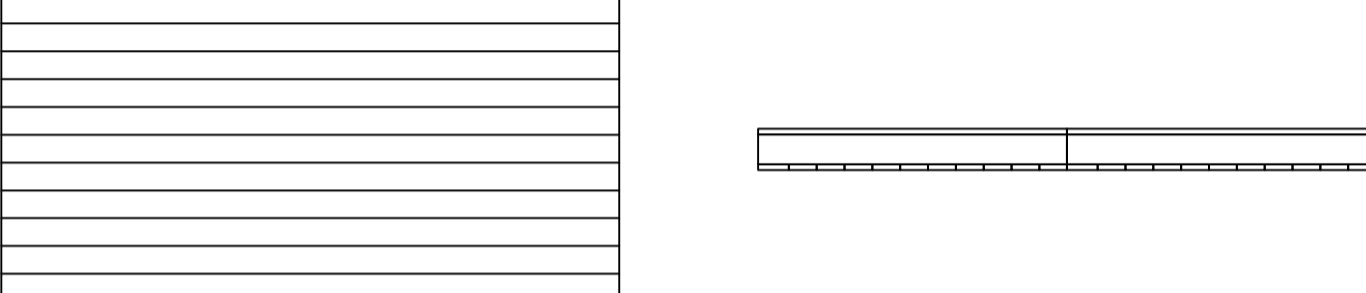
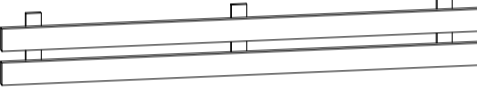

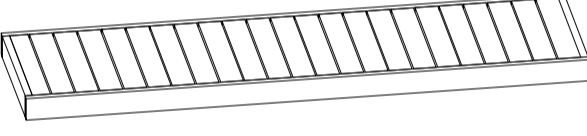
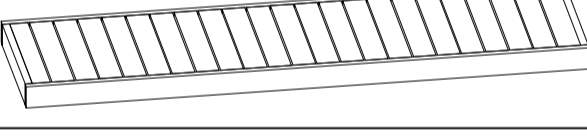



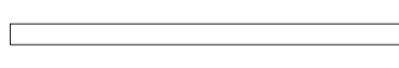
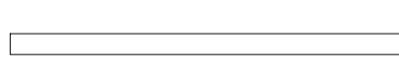
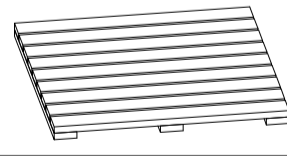
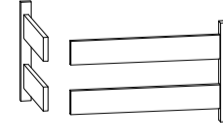
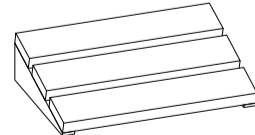
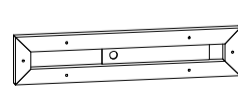
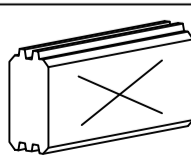
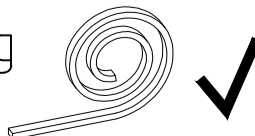

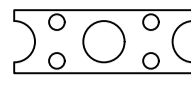
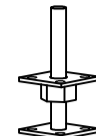
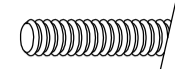
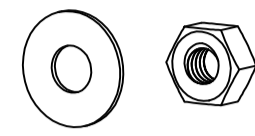
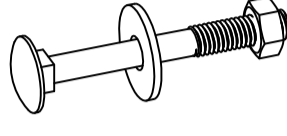



Pos	Teilleiste/Specification Hansa Corner Sauna A 700x360+SD+Terr 70	Stck Pcs.	Profil Profile (mm)	Länge Length (mm)
	Achtung! Die Giebelbohlen können teilweise schon vormontiert sein! Bitte beachten - diese erscheinen nicht ganz so wie in der Teilleiste beschrieben.			
	Notice! The gable pieces can be partly pre-assembled! Please notice - those differ from the description given in the specification list.			
000	Extra Log 	1	70x135	5440
001		4	70x135	5440
002		5	70x135	4835
003		5	70x135	4835
004		1	70x68	4835
005		1	70x135	4835
006		2	70x135	4519
007		1	70x135	4328
008*	Mit pos 009 tauschen, wenn Haus spiegelverkehrt gebaut wird - Switch position with 009 if house is built mirrored 	1	70x135	4285
009		1	70x135	4285
010*	Mit pos 011 tauschen, wenn Haus spiegelverkehrt gebaut wird - Switch position with 011 if house is built mirrored 	1	70x63	4285
011		1	70x63	4285
012		1	70x135	4285
013		12	70x135	3935
014		1	70x135	3908
015		1	70x135	3900
016*	Mit pos 017 tauschen, wenn Haus spiegelverkehrt gebaut wird - Switch position with 017 if house is built mirrored 	1	70x127	3900
017		1	70x127	3900
018		1	70x68	3760
019		1	70x135	3760
020		4	70x135	3708
021		5	70x135	3708
022		1	70x135	3615
Kood	Hansa Corner Sauna A 700x360+SD+Terr 70	File	Hansa Corner Sauna A 700x360+SD+Terr 70.dwg	





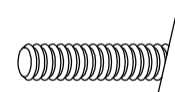
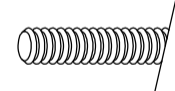
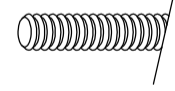

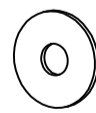
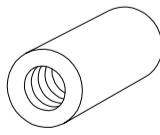

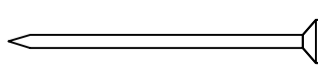
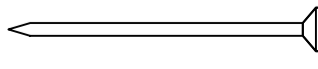

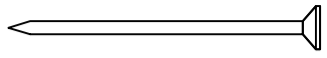
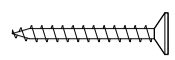
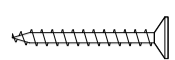

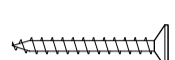

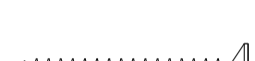

Pos	Teilleiste/Specification Hansa Corner Sauna A 700x360+SD+Terr 70	Stck Pcs.	Profil Profile (mm)	Länge Length (mm)
023*	Mit pos 024 tauschen, wenn Haus spiegelverkehrt gebaut wird - Switch position with 024 if house is built mirrored 	1	70x63	3615
024		1	70x63	3615
025*	Mit pos 026 tauschen, wenn Haus spiegelverkehrt gebaut wird - Switch position with 026 if house is built mirrored 	1	70x135	3615
026		1	70x135	3615
027*	Mit pos 028 tauschen, wenn Haus spiegelverkehrt gebaut wird - Switch position with 028 if house is built mirrored 	1	70x89	3600
028		1	70x89	3600
029		19	70x135	3600
030		2	70x135	3600
031		1	70x135	3600
032		1	70x135	3600
033		5	70x135	3535
034		12	70x135	3465
035		5	70x135	3465
036		2	70x64	3400
037		1	70x135	3288
038		2	70x114	2781
039		8	70x135	2533
040		1	70x135	2533
041		1	70x64	2450
042		1	70x135	2450
043		17	70x135	2300
044		1	70x68	2300
045		9	70x135	2165
046		2	70x135	2165
047		1	70x68	2165

Pos	Teileliste/Specification Hansa Corner Sauna A 700x360+SD+Terr 70	Stck Pcs.	Profil Profile (mm)	Länge Length (mm)
048		3	70x135	973
049		1	70x135	973
050		15	70x135	745
051		15	70x135	745
052		8	70x135	740
053		13	70x135	593
054		1	70x135	470
055		19	70x135	470
056		8	70x135	470
057		4	70x135	470
058		15	70x135	410
059		1	70x68	360
060		14	70x135	360
FH13	FUNDAMENTHOLZ (imprägniert) - FOUNDATION BEAM (impregnated) 	1	70x95	3940
FH1	FUNDAMENTHOLZ (imprägniert) - FOUNDATION BEAM (impregnated) 	1	70x95	3390
FH14	FUNDAMENTHOLZ (imprägniert) - FOUNDATION BEAM (impregnated) 	1	70x95	3290
FH4	FUNDAMENTHOLZ (imprägniert) - FOUNDATION BEAM (impregnated) 	2	45x95	4680
FH6	FUNDAMENTHOLZ (imprägniert) - FOUNDATION BEAM (impregnated) 	2	45x95	4623
FH7	FUNDAMENTHOLZ (imprägniert) - FOUNDATION BEAM (impregnated) 	5	45x95	4578
FH8	FUNDAMENTHOLZ (imprägniert) - FOUNDATION BEAM (impregnated) 	1	45x95	3965
FH10	FUNDAMENTHOLZ (imprägniert) - FOUNDATION BEAM (impregnated) 	1	45x95	3940
FH17	FUNDAMENTHOLZ (imprägniert) - FOUNDATION BEAM (impregnated) 	1	45x95	3380
FH9	FUNDAMENTHOLZ (imprägniert) - FOUNDATION BEAM (impregnated) 	1	45x95	3355
FH2	FUNDAMENTHOLZ (imprägniert) - FOUNDATION BEAM (impregnated) 	7	45x95	3230
FH11	FUNDAMENTHOLZ (imprägniert) - FOUNDATION BEAM (impregnated) 	1	45x95	3200

Pos	Teileliste/Specification Hansa Corner Sauna A 700x360+SD+Terr 70		Stck Pcs.	Profil Profile (mm)	Länge Length (mm)
FH3	FUNDAMENTHOLZ (imprägniert) - FOUNDATION BEAM (impregnated) 		2	45x95	2010
FH5	FUNDAMENTHOLZ (imprägniert) - FOUNDATION BEAM (impregnated) 		4	45x95	1997
FH15	FUNDAMENTHOLZ (imprägniert) - FOUNDATION BEAM (impregnated) 		5	45x95	1920
FH16	FUNDAMENTHOLZ (imprägniert) - FOUNDATION BEAM (impregnated) 		5	45x95	1190
FH12	FUNDAMENTHOLZ (imprägniert) - FOUNDATION BEAM (impregnated) 		4	45x95	496
HS1	HOLZSCHWELLE - THRESHOLD (unter der Saunatur - under Sauna door) 		✓ 1	75x28	810
PF2	PFETTEN - PURLINS 		3	58x170	4250
PF1	PFETTEN - PURLINS 		3	58x170	3950
PF4	PFETTEN - PURLINS 		2	58x170	3900
PF3	PFETTEN - PURLINS 		1	58x170	3900
	DACHBRETTER - ROOF BOARDS 		15+2 15	113x18	4885 2315
	DACHBRETTER - ROOF BOARDS 		35	113x18	3800
	DACHBRETTER - ROOF BOARDS 		20 20	113x18	3685 3515
	FUSSBODENBRETTER - FLOOR BOARDS 		41+1	113x28	3255
	FUSSBODENBRETTER - FLOOR BOARDS 		29	113x28	1955
	TERRASSENBRETTER (imprägniert) - TERRACE BOARDS (impregnated) 		27+1	120x28	4000
	DECKENLEISTEN - CEILING STRIPS 		✓	15x28	33.0 lfm/rm
	FUSSBODENLEISTEN - FLOOR STRIPS 		✓	14x55	33.0 lfm/rm
DPL-1	DACHPAPPENLEISTEN - ROOFING FELT STRIPS 15x28 		✓	15x28	23.0 lfm/rm
T06-1	TRAUFENLEISTEN - EAVES STRIPS 18x40 		✓	18x40	16.0 lfm/rm
BL-1	DACHBLENDEN - PARAPET 336mm Wände/Walls B, D 		2	18x336	3400
BL-2	DACHBLENDEN - PARAPET 336mm Wände/Walls A, D 		2	18x336	3900
BL-3	DACHBLENDEN - PARAPET 336mm Wände/Walls 1, 4 		2	18x336	3936
BL-4	DACHBLENDEN - PARAPET 336mm Wände/Walls 1, 2 		2	18x336	4000
UPB-1	DACHBLENDEN- U-Profil für Blenden - PARAPET- U-Profile 		✓	65x44	31.0 lfm/rm
Kood	Hansa Corner Sauna A 700x360+SD+Terr 70		File	Hansa Corner Sauna A 700x360+SD+Terr 70.dwg	

Pos	Teileliste/Specification Hansa Corner Sauna A 700x360+SD+Terr 70		Stck Pcs.	Profil Profile (mm)	Länge Length (mm)	
BS-1	DACHBLENDEN- Blendenstützen - PARAPET- Parapet support 44x65		10	44x65	250	
VL-1	DACHBLENDEN- Verbindungsleisten - PARAPET- connecting strips		2	18x120	336	
TP 120-1	STÜTZPFOSTE - SUPPORT POST 120x120		✓	1	120x120	2062
TP 120-2	STÜTZPFOSTE - SUPPORT POST 120x120		✓	1	120x120	2090
TL70-1	T-LEISTEN - T-STRIPS 70		4	45x70	490	
TL70-2	T-LEISTEN - T-STRIPS 70		2	45x70	1705	
TL70-3	T-LEISTEN - T-STRIPS 70		2	45x70	1908	
TL7 0-4	T-LEISTEN - T-STRIPS 70		4	45x70	1975	
SLK	DECKENISOLATION/ CEILING ISOLATION		2 Elemente	ca 1950x975		
SA16-1	SAUNA- Bänke Zwischenstück - Benches spacer		1	40x300	1955	
SA15-1	SAUNA- Rücklehne - Backrest		2	40x250	1860	
SA02-1	SAUNA- Saunabank - Sauna bench 50cm		1	500x90	1355	
SA01-1	SAUNA- Saunabank - Sauna bench 60cm		2	600x90	1955	
SA11-1	SAUNA- Stützpfeosten für Saunabänke - Support posts for sauna benches		✓	1	44x65	500
SA11-2	SAUNA- Stützpfeosten für Saunabänke - Support posts for sauna benches		✓	2	44x65	1000
SA20-1	SAUNA- Trägleiste für Deckenisolation - Carrier strip for ceiling isolation		✓	4	35x35	2000
SA10-1	SAUNA- Trägleiste für Saunabänke - Carrier strip for sauna benches		✓	3	30x40	600
SA10-2	SAUNA- Trägleiste für Saunabänke - Carrier strip for sauna benches		✓	2	30x40	1200
SA37	SAUNA- Bodenrost - Slatted floor mat		1			
SA30	SAUNA- Heizung Umbau - Heater cover (set 1)		1			
SA35	SAUNA- Kopfstütze - Headrest		2			
SA36	SAUNA- Luftschieber - Air slide		3			
SH	SCHLAGHÖLZER - MOUNTING PIECES		3			
SA25-1	SAUNA- Dichtungsband für Deckenisolationselemente - Seal for ceiling insulation elements		✓	1	8.0 lfm/rm	
Kood	Hansa Corner Sauna A 700x360+SD+Terr 70		File	Hansa Corner Sauna A 700x360+SD+Terr 70.dwg		

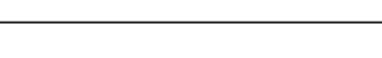
Pos	Teileliste/Specification Hansa Corner Sauna A 700x360+SD+Terr 70		Stck Pcs.	Profil Profile (mm)	Länge Length (mm)
VS	Verbindungsstreifen für verbinden der Wandbohlen - Connecting strip for connecting the wall parts		32		
VP3	Verstellbare Pfostenstütze - Adjustable post support M20		2		
KL-1	Gewindestange - Threaded rod M12- für die Pfetten - for purlins		6		170
MUT26	Mutter - Nut M12 U-Scheibe - Washer Ø30- für die Pfetten - for purlins		12		
SS022	Schloßschrauben - Wood bolts M8x70 Mutter - Nut M8 U-Scheibe - Washer Ø25		2		
ML1	Metallstange - Metal bar		1	D10	1100
ML2	Metallstange - Metal bar		2	D10	1040
ML3	Metallstange - Metal bar		4	D10	970
ML4	Metallstange - Metal bar		7	D10	900
ML5	Metallstange - Metal bar		4	D10	770
ML6	Metallstange - Metal bar		4	D10	670
ML7	Metallstange - Metal bar		3	D10	500
ML8	Metallstange - Metal bar		2	D10	420
ML9	Metallstange - Metal bar		2	D10	360
KL1	Gewindestange - Threaded Rod M8		4		2000
KL2	Gewindestange - Threaded Rod M8		2		592
KL3	Gewindestange - Threaded Rod M8		2		506
KL4	Gewindestange - Threaded Rod M8		4		405
KL5	Gewindestange - Threaded Rod M8		3		333
KV M UT M8	Mutter - Nut M8		22		
KV S EIB M8X25	U-Scheibe - Washer M8 Ø25		22		
KV MU TJ M8	Befestigungsmutter - Fixing nut M8		4		
NG2 550	NÄGEL - NAILS 2.5x50 Dachbretter - Roof boards		1260		
NG2 560	NÄGEL - NAILS 2.5x60 Fussbodenbretter - Floor boards		864		
NG2 560	NÄGEL - NAILS 2.5x60 Terrassenbretter - Terrace boards		432		
Kood	Hansa Corner Sauna A 700x360+SD+Terr 70		File	Hansa Corner Sauna A 700x360+SD+Terr 70.dwg	

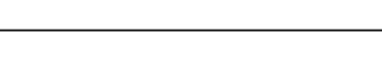
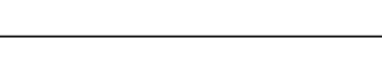
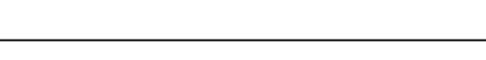
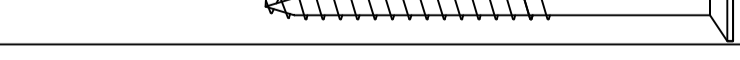
Pos	Teileliste/Specification Hansa Corner Sauna A 700x360+SD+Terr 70		Stck Pcs.	Profil Profile (mm)	Länge Length (mm)
NG2 560	NÄGEL - NAILS 2.5x60	Holzschwelle - Threshold		5	
SR3 030	Schrauben - Screws 3.0x30	Dachblenden Verbindungsleisten - Parapet Connecting strips		16	
SR3 030	Schrauben - Screws 3.0x30	Dachpappeleisten - Roofing felt		46	
SR3 030	Schrauben - Screws 3.0x30	Deckenleisten - Ceiling strips		70	
SR3 030	Schrauben - Screws 3.0x30	Fussbodenleisten - Floor strips		70	
SR303 0-002	Schrauben - Screws 3.0x30	Sauna- Bänke Zwischenstück - Benches spacer		6	
SR303 0-001	Schrauben - Screws 3.0x30	Sauna- Luftschieber - Air slide		18	
SR3 030	Schrauben - Screws 3.0x30	Traufenleisten - Eaves strips		32	
SR37	Schrauben - Screws 3.5x45	Fenster- und Türleisten - Window and door strips		136	
SR354 5-002	Schrauben - Screws 3.5x45	Sauna- Heizung Umbau - Heater cover		8	
SR3 545	Schrauben - Screws 3.5x45	U-Profil für Blenden - Parapet U-Profile		64	
SR354 5-001	Schrauben - Screws 3.5x45	Verbindungsstreifen - Connecting strip		128	
SR35 45-02	Schrauben - Screws 3.5x45	Verbreiterungsleiste - Frame extensions D930-RT		10	
SR406 0-003	Schrauben - Screws 4.0x60	Sauna- Rücklehne - Backrest		6	
SR406 0-001	Schrauben - Screws 4.0x60	Sauna- Trägleiste für Deckenisolation - Carrier strip for ceiling isolation		16	
SR406 0-002	Schrauben - Screws 4.0x60	Sauna- Trägleiste für Saunabänke - Carrier strip for sauna benches		21	
SR5 0100	Schrauben - Screws 5.0x100	Fundamenthölzer - Foundation beams		176	
SR5 0100	Schrauben - Screws 5.0x100	Stützpfofte - Support post		4	
SR5 070	Schrauben - Screws 5.0x70	Blendenbefestigung - Parapet mounting		50	
SR5 070	Schrauben - Screws 5.0x70	Blendenstützen - Parapet support		20	
SR507 0-001	Schrauben - Screws 5.0x70	Sauna- Stützpfoften für Saunabänke - Support post for Sauna benches		9	
SR507 0-002	Schrauben - Screws 5.0x70	Verstellbare pfoftenstütze - Post support		16	
SR50 90-01	Schrauben - Screws 5.0x90	Türrahmen - Door frames D930-RT		8	
SR6 0140	Schrauben - Screws 6.0x140	Blendenstützen - Parapet support		20	
Kood	Hansa Corner Sauna A 700x360+SD+Terr 70		File	Hansa Corner Sauna A 700x360+SD+Terr 70.dwg	

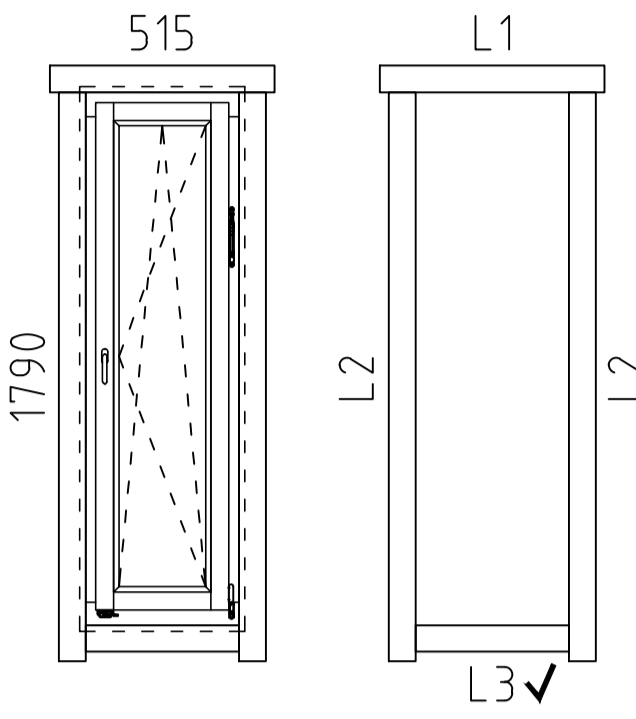
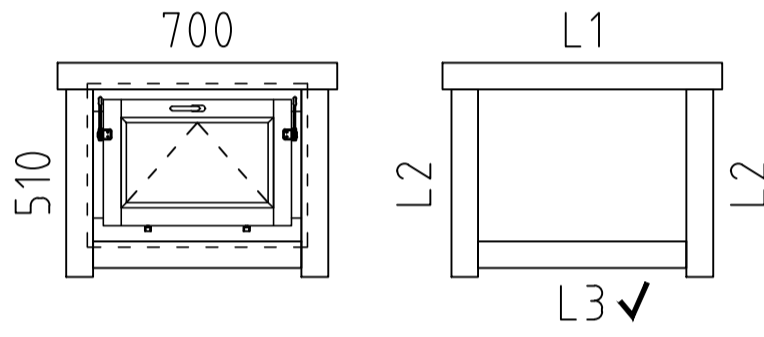
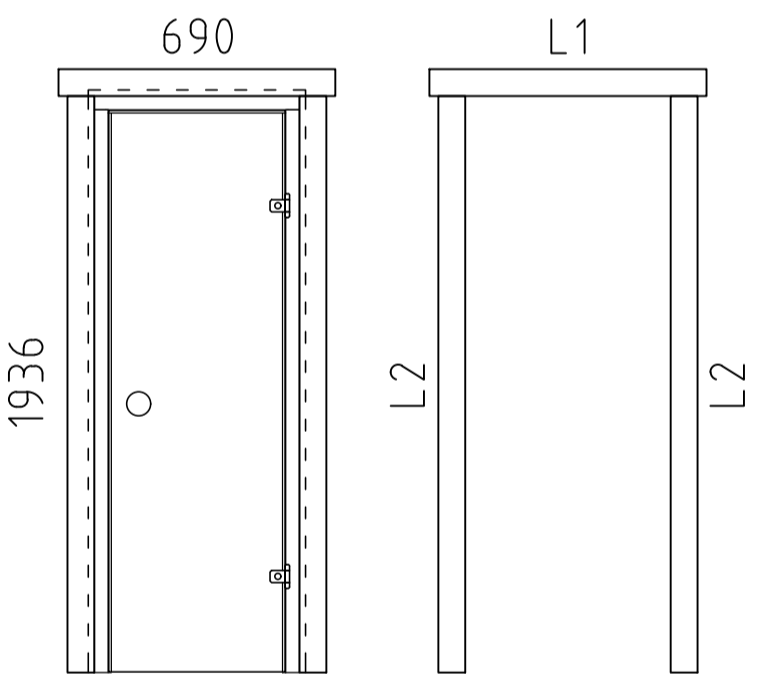
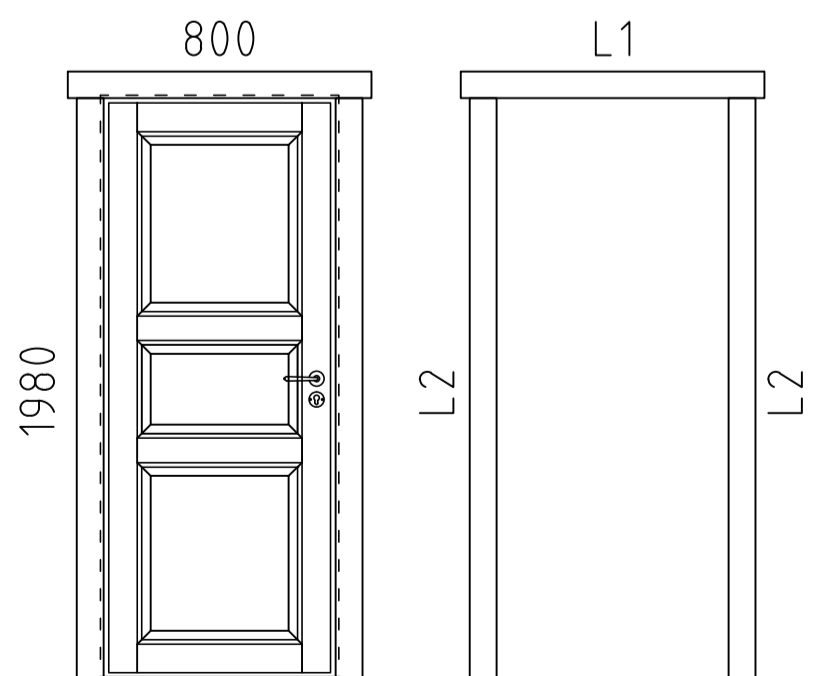
Pos	Teileliste/Specification Hansa Corner Sauna A 700x360+SD+Terr 70	Stck Pcs.	Profil Profile (mm)	Länge Length (mm)
	<p>FENSTER/WINDOW 515x1790 W5-S70P-0XT-05151790</p>  <p>RA68-10 / W121-PT</p> <p>L1 18x90 L=755mm 2x L2 18x90 L=1910mm 4x L3 18x90 L=515mm 2x ✓</p>	1		
	<p>FENSTER/WINDOW 700x510 W5-S70K-0XT-07000510</p>  <p>RA68-24K / W106-KT</p> <p>L1 18x90 L=940mm 2x L2 18x90 L=630mm 4x L3 18x90 L=700mm 2x ✓</p>	2		
	<p>TÜR/DOOR 690x1936 D0-L70R-0XT-06901936</p>  <p>LR / D930-RT</p> <p>L1 18x90 L=930mm 2x L2 18x90 L=1935mm 4x</p> <p>DIN rechts/right handed</p>	1		
	<p>TÜR/DOOR 800x1980 D0-I70L-XXX-08001980</p>  <p>SU3_LPT / D913-LX</p> <p>L1 18x90 L=1020mm 2x L2 18x90 L=1970mm 4x ✓</p> <p>DIN links/left handed</p>	1		

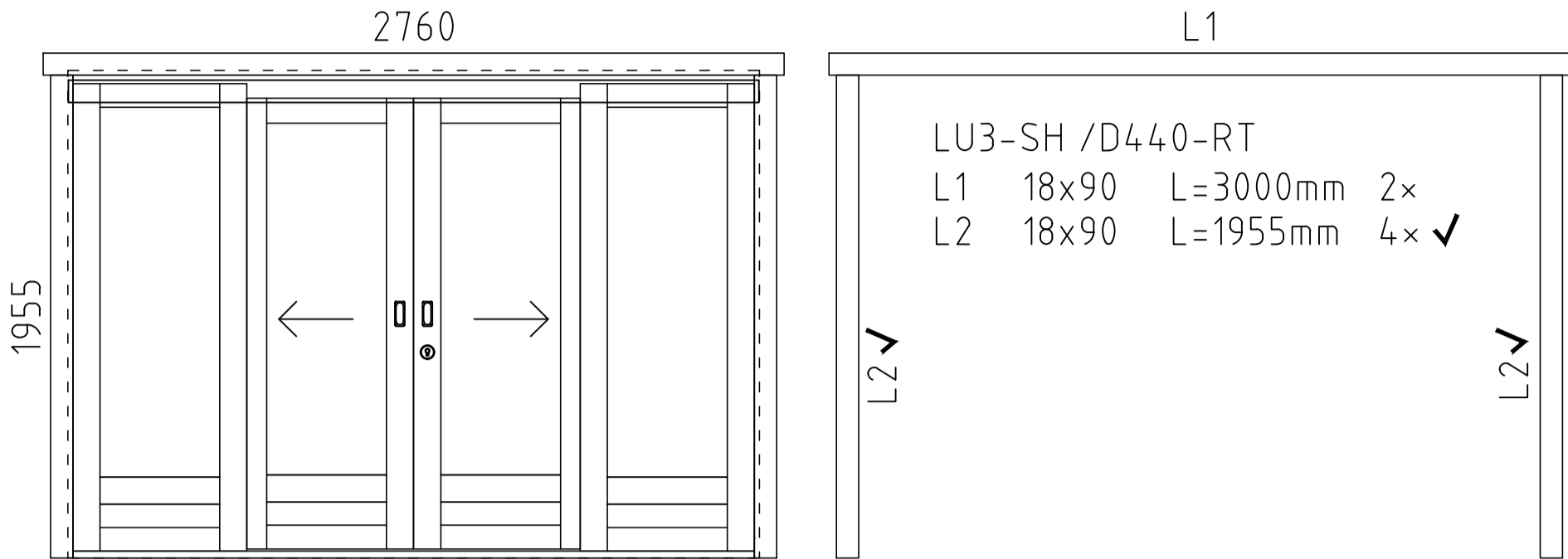
Pos	Teileliste/Specification Hansa Corner Sauna A 700x360+SD+Terr 70	Stck Pcs.	Profil Profile (mm)	Länge Length (mm)
	<p style="text-align: center;">TÜR/DOOR 2760x1955 D5-U70R-0XT-27601955</p> 	1		
	* - Bei originalaufbau nicht nötig! / Not needed by standard build-up!			
	✓ - Bitte selber anpassen (falls nötig)! / Cut into length on site (if needed)!			
Kood	Hansa Corner Sauna A 700x360+SD+Terr 70	File	Hansa Corner Sauna A 700x360+SD+Terr 70.dwg	

Montageanleitung für T-Leisten / Installing the door and window supports / Tenderliistu paigaldusjuhend.

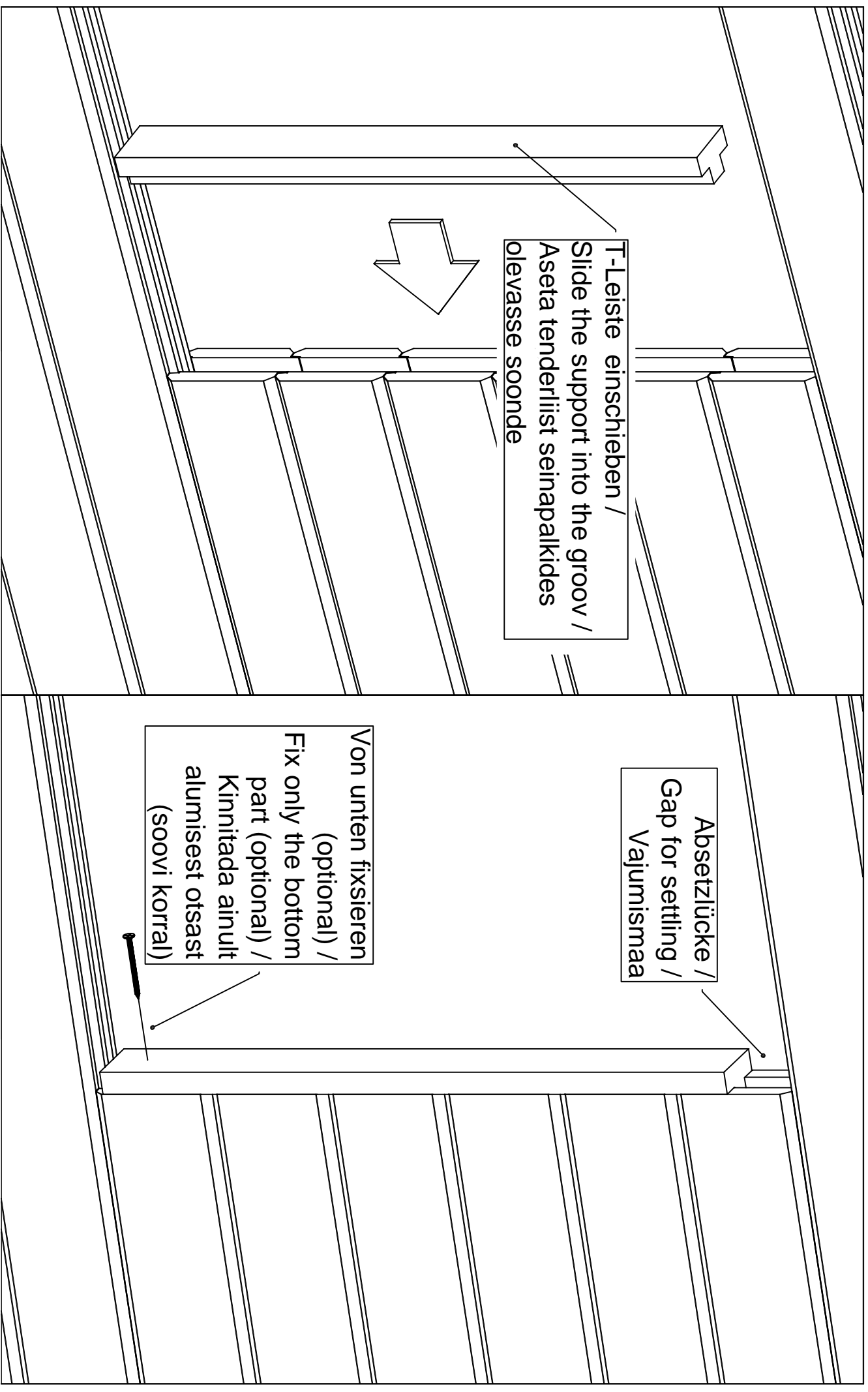

Aken	Q4-Q6	-	paigaldusjuhis
Window	Q4-Q6	-	assembly instructions
Fenster	Q4-Q6	-	Montageanleitung

5-10mm

3.5x45

Lõika mõõtu
Cut to length
Absägen
- 10mm / -20mm

NB!

3.5x45

Vihmaliist / Rain strip / Wasserleiste

Q5-Q6

*Silikoon

*Silicon

*Silikon

*Vajumispilu

*Settling gap

*Senkungs spalt

ca 40-50mm

NB!

- Monteerida juhul kui ese on välja toodud maja spetsifikatsioonis!
- Install only if the item is listed in the house specification!
- Nur montieren wenn die Leiste in der Teileliste gezeigt ist!

Veeplekk / Window sill / Fensterbank

4,2x16

Ø4
3mm
13mm
2x

3 Special Profile

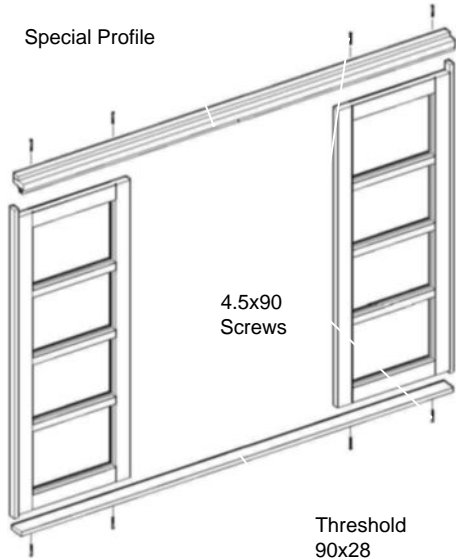

1
Special Profile

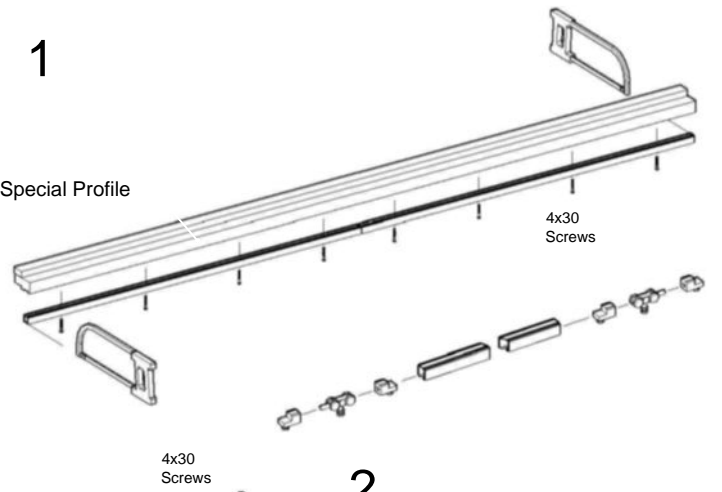

4x30
Screws

2

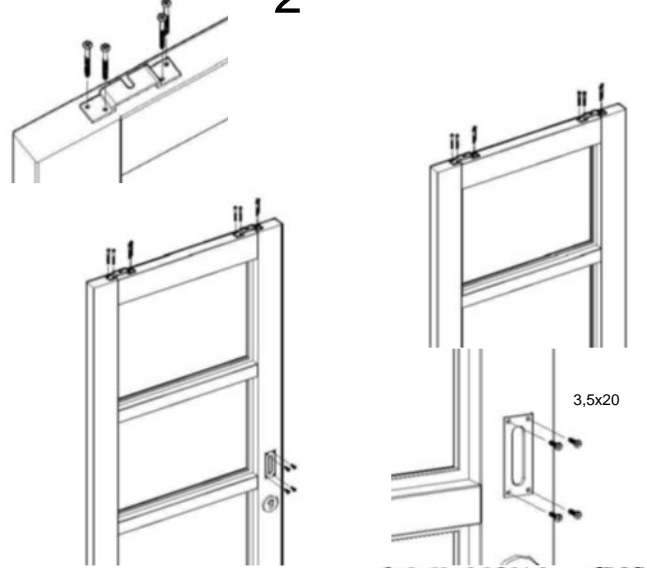

4

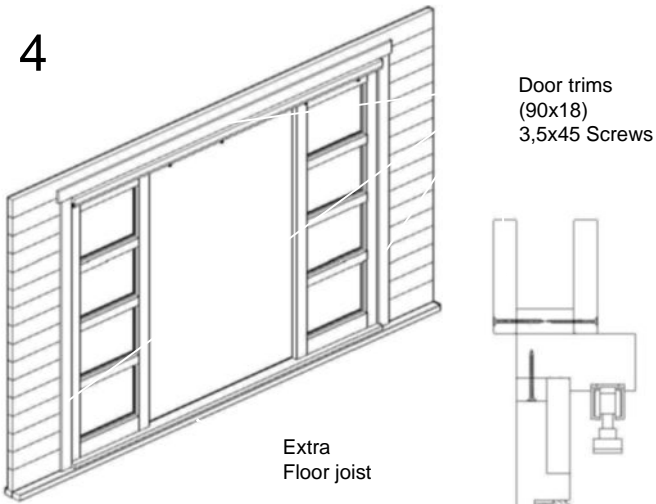

5

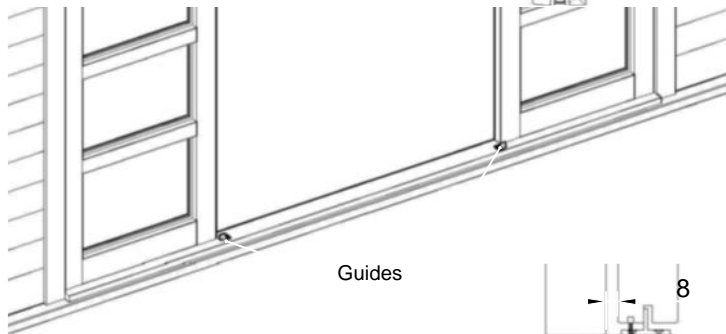
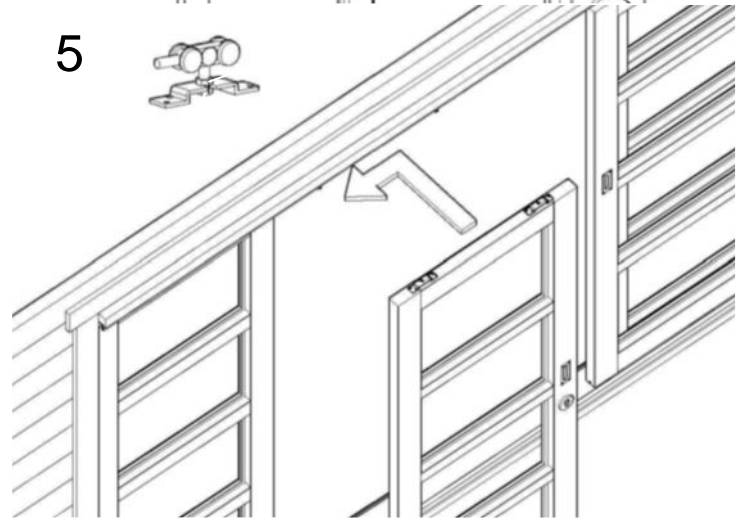

6

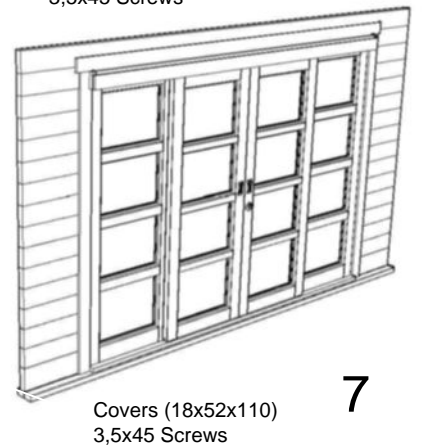
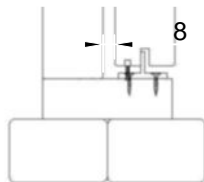
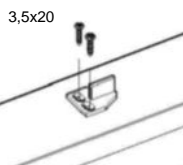

7

Ø4 3mm 13mm
2x

1

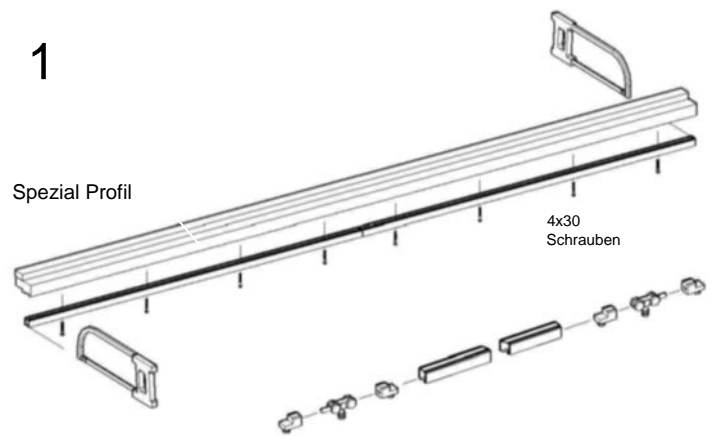

3

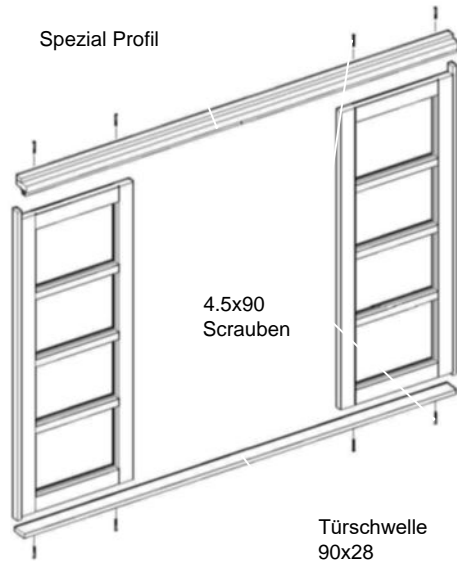

4x30 Schrauben

2

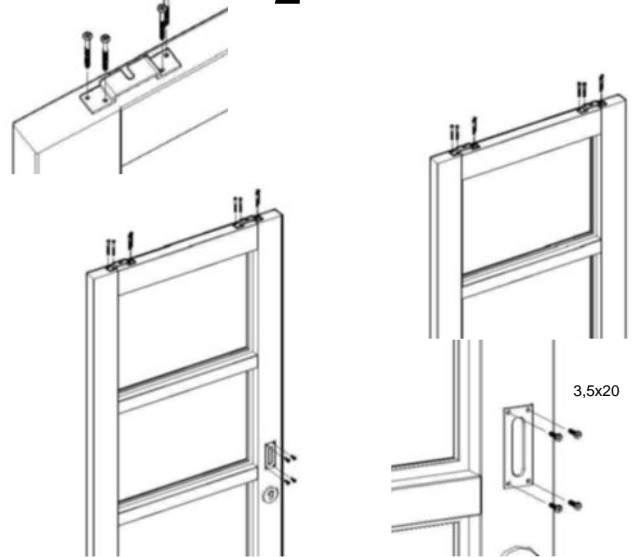

4

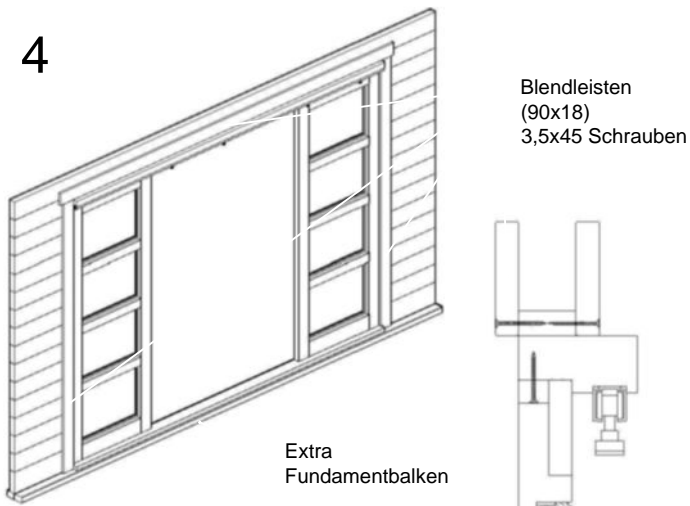

5

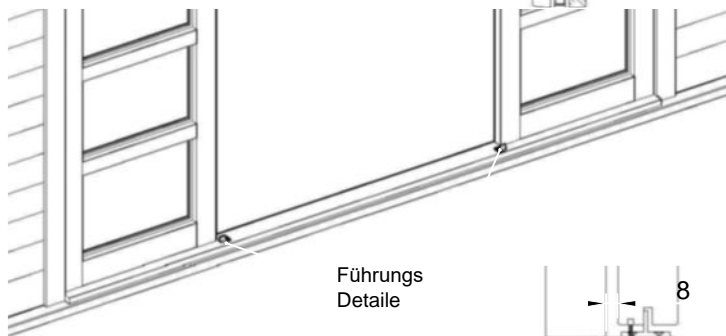
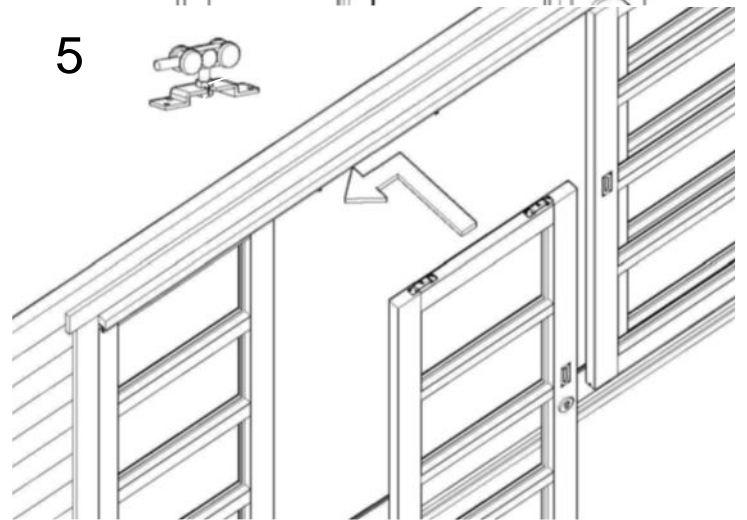

6

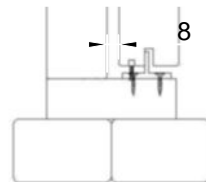
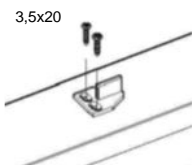

Deckbrett (90x18)
3,5x45 Schrauben

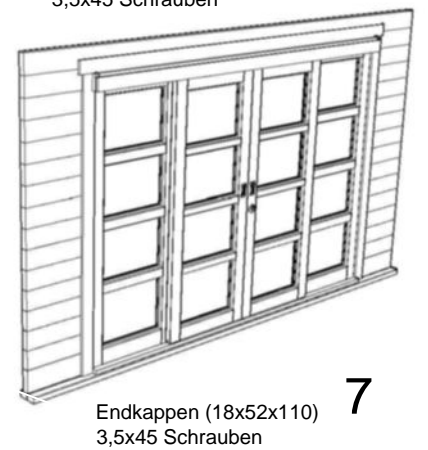

7

D930-RT

Installation instructions / Aufbauanleitung / Paigaldusjuhend

1

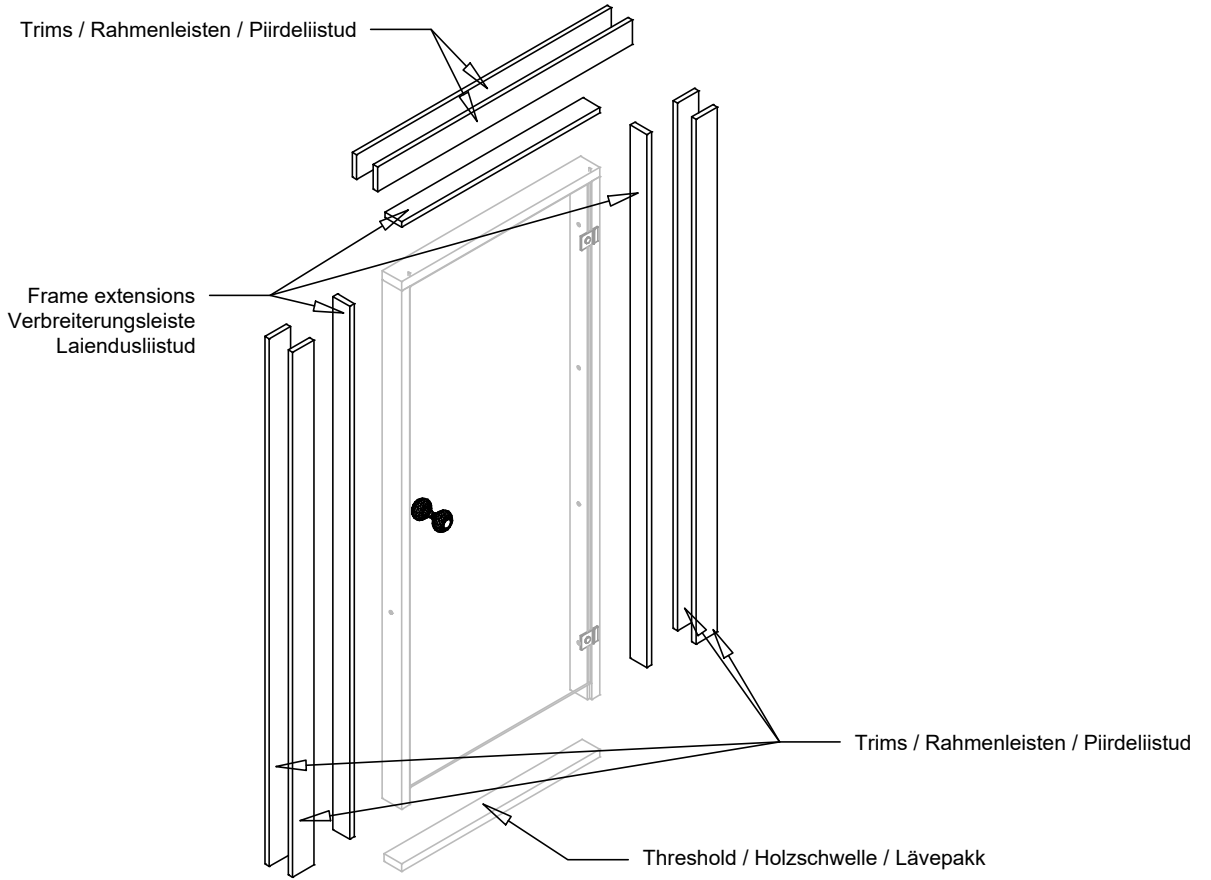

2

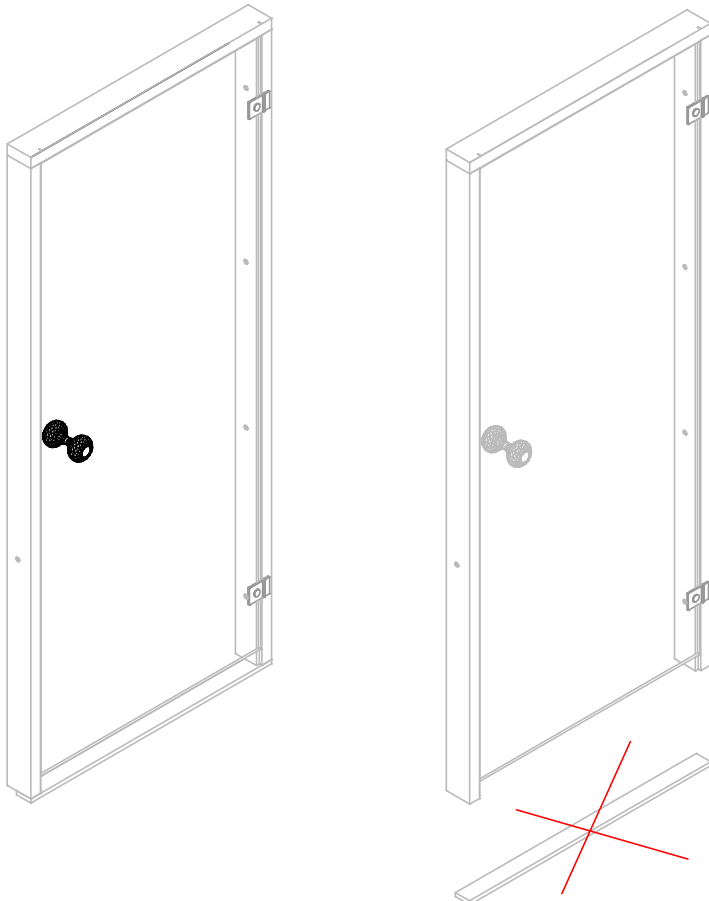

NB! Remove the transport strip!

NB! Entfernen Sie die
Transportleiste!

NB! Eemaldage transpordiliist!

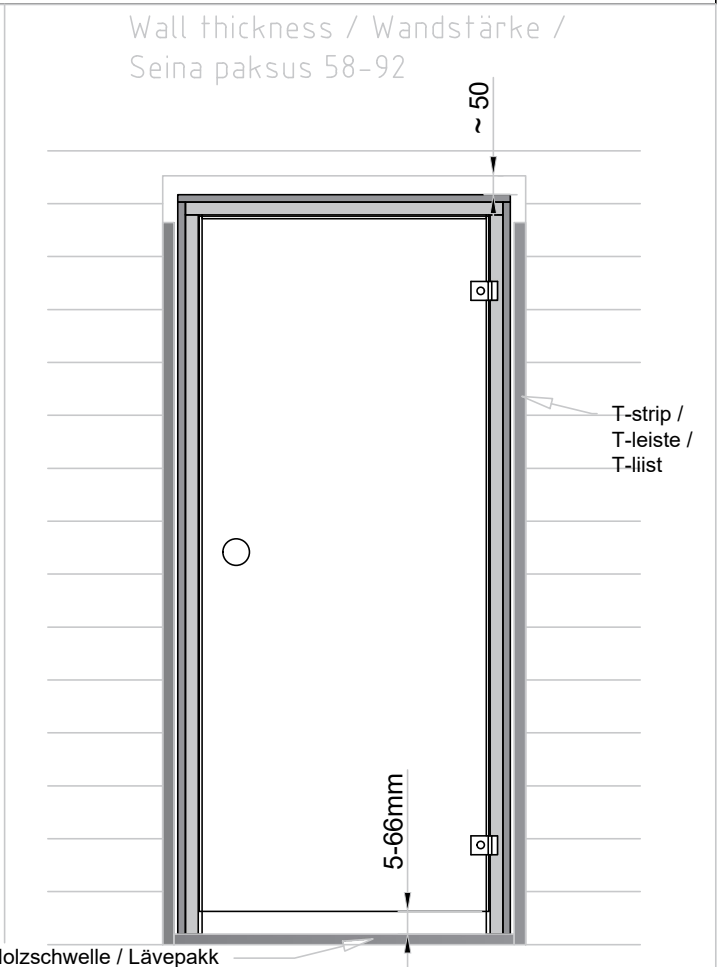
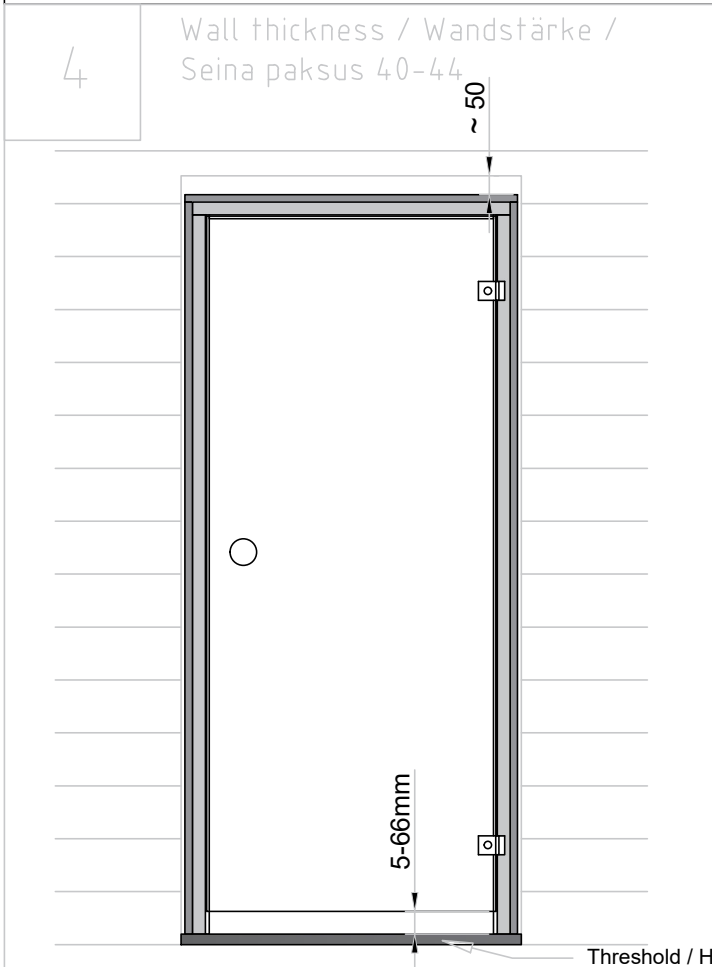
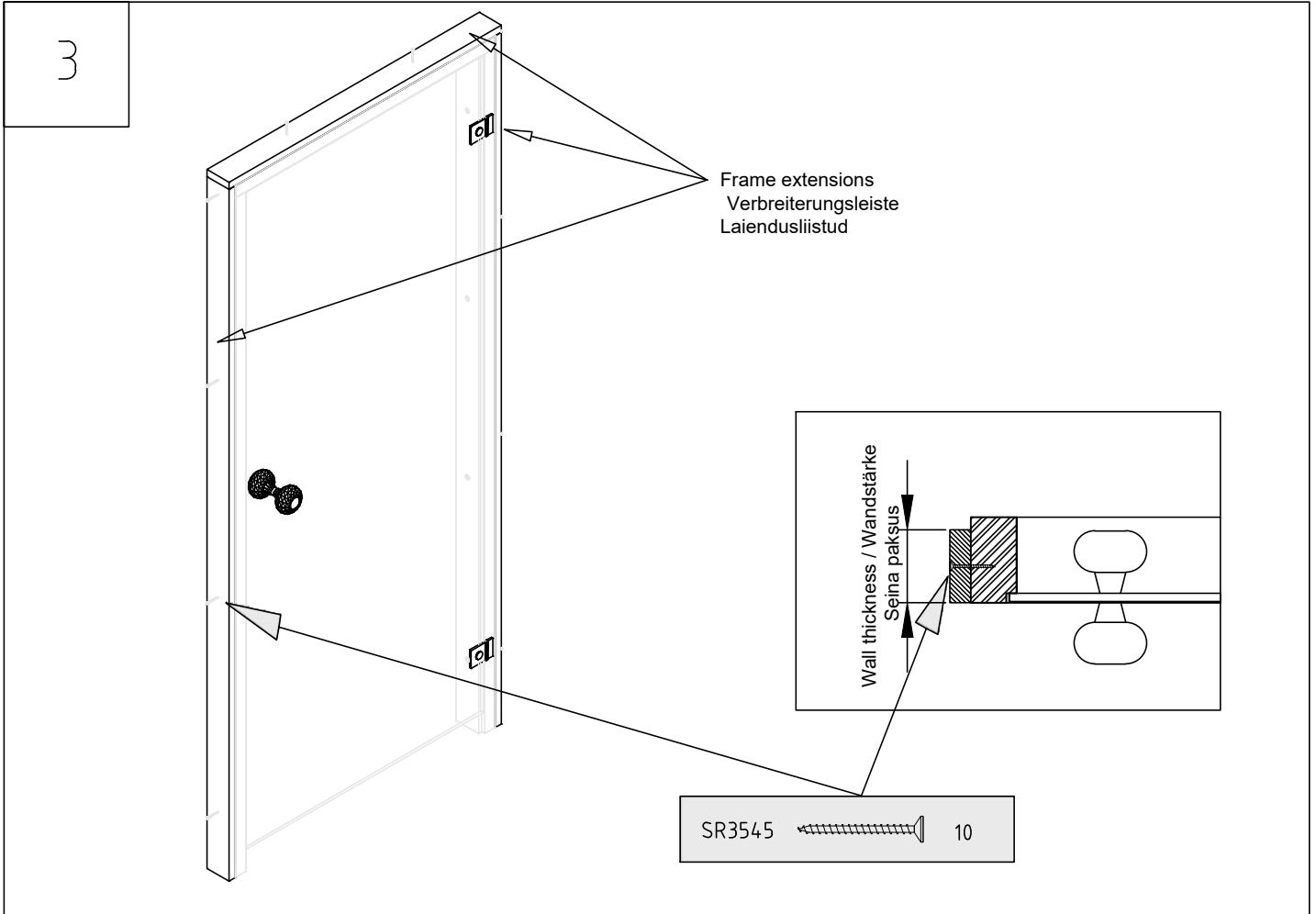

5

Wall thickness / Wandstärke / Seina paksus 40-44

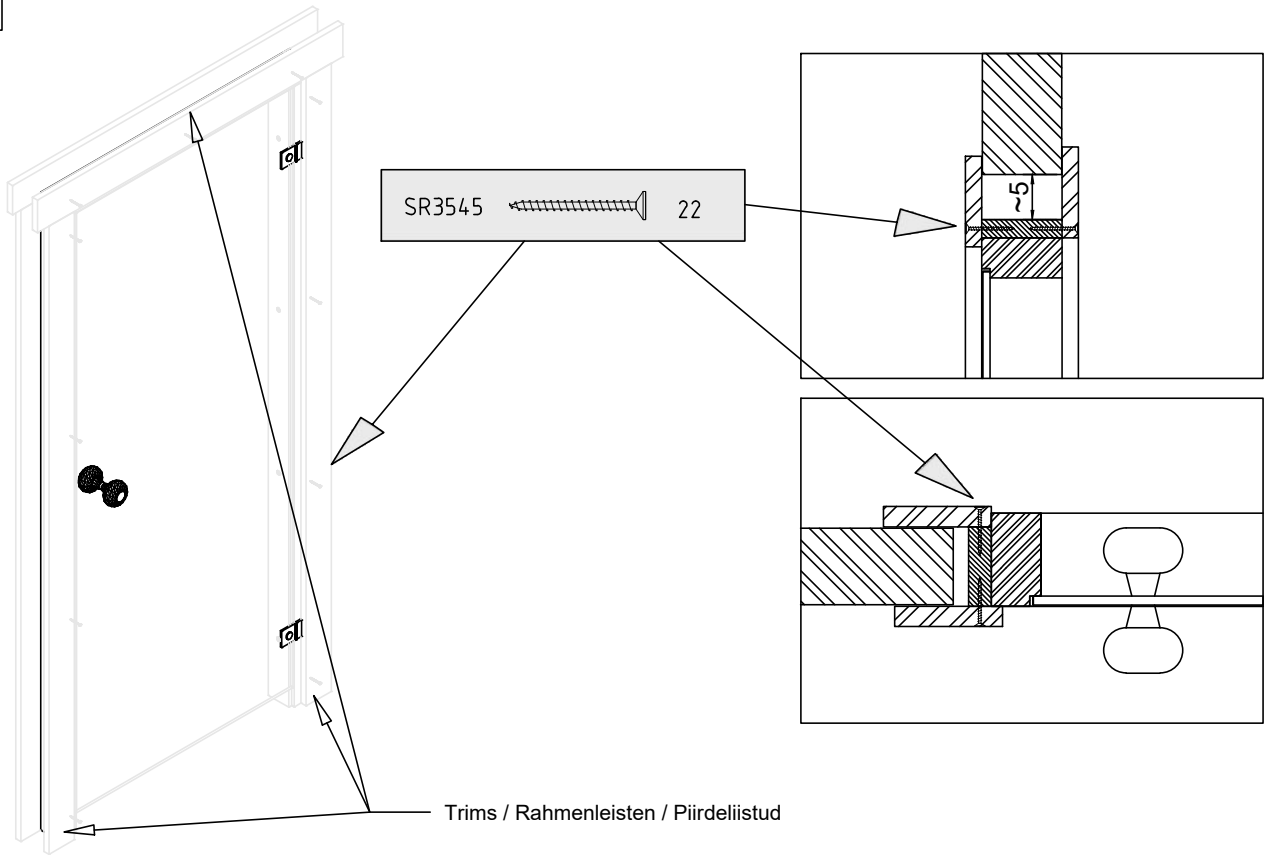

5

Wall thickness / Wandstärke / Seina paksus 58-92

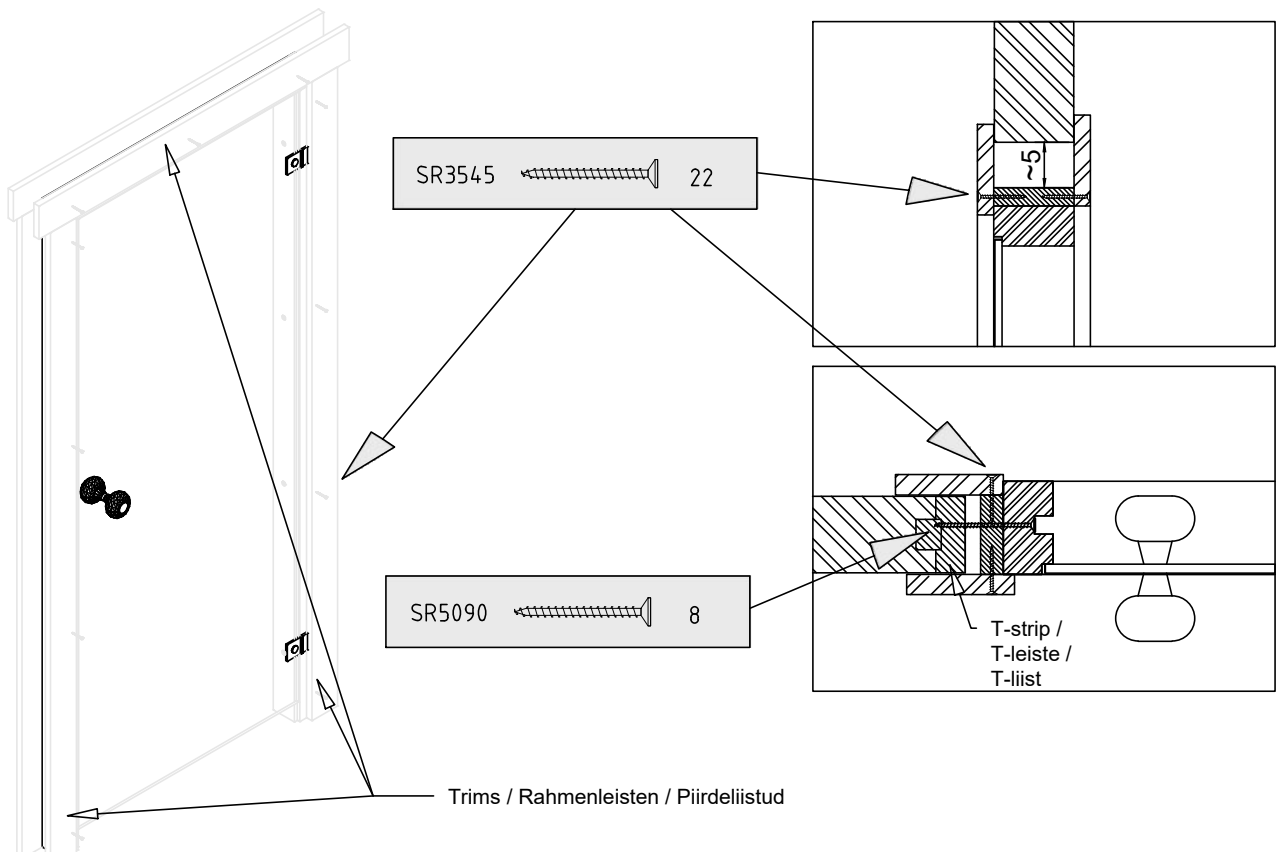

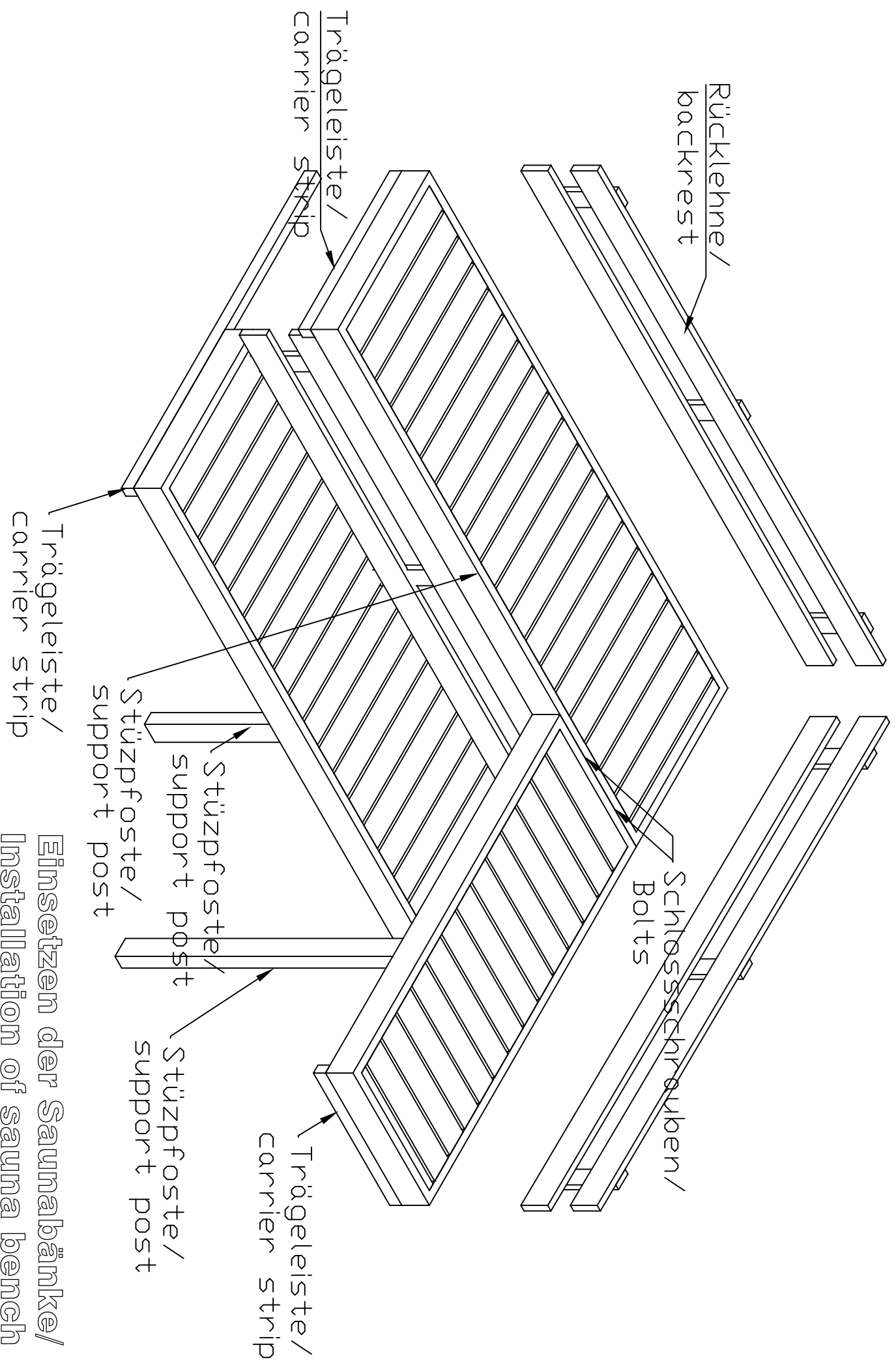

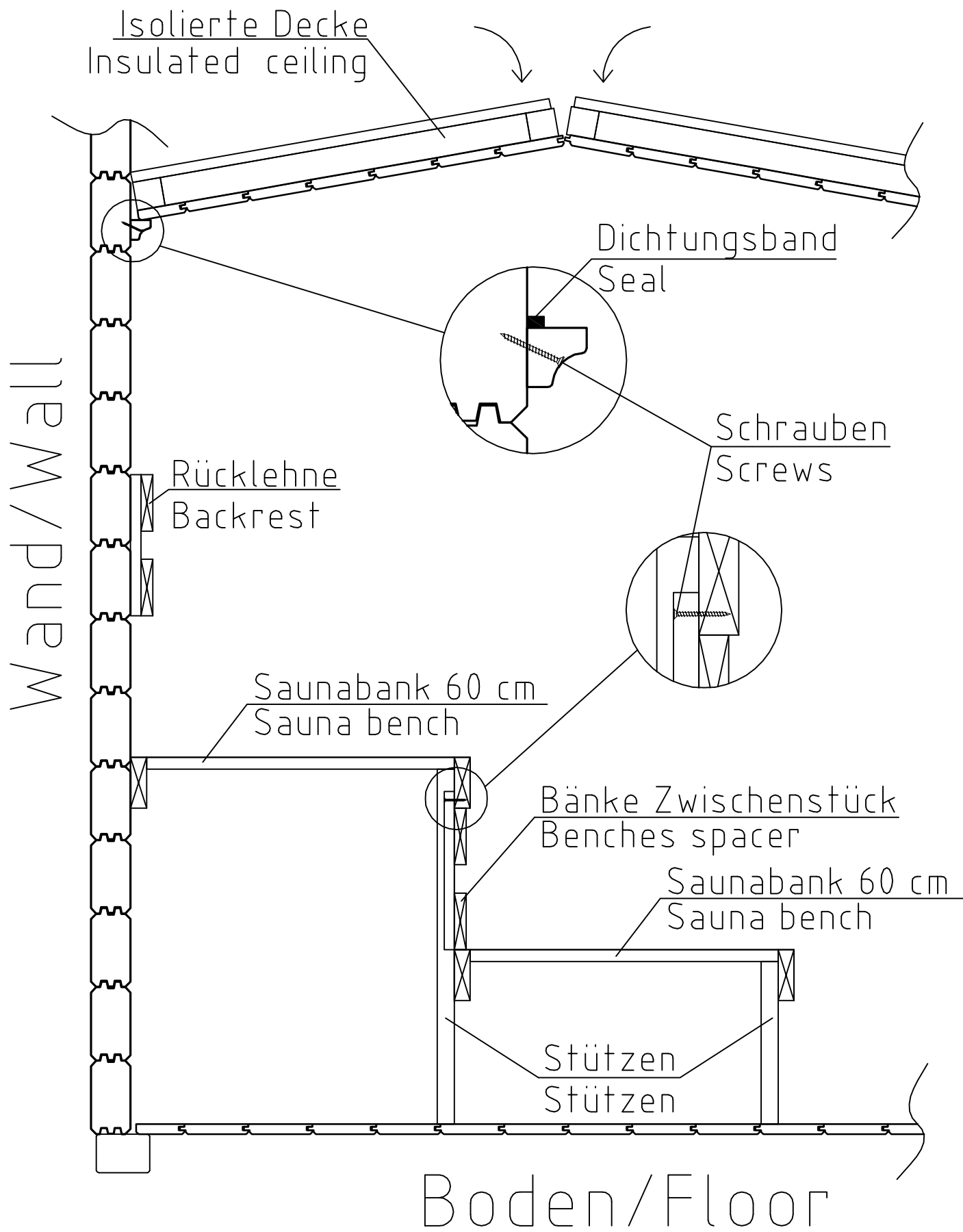

Montage Bänke und Zwischen Decke/
Installation of sauna furniture

Schnitt/ Section

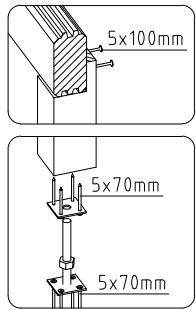
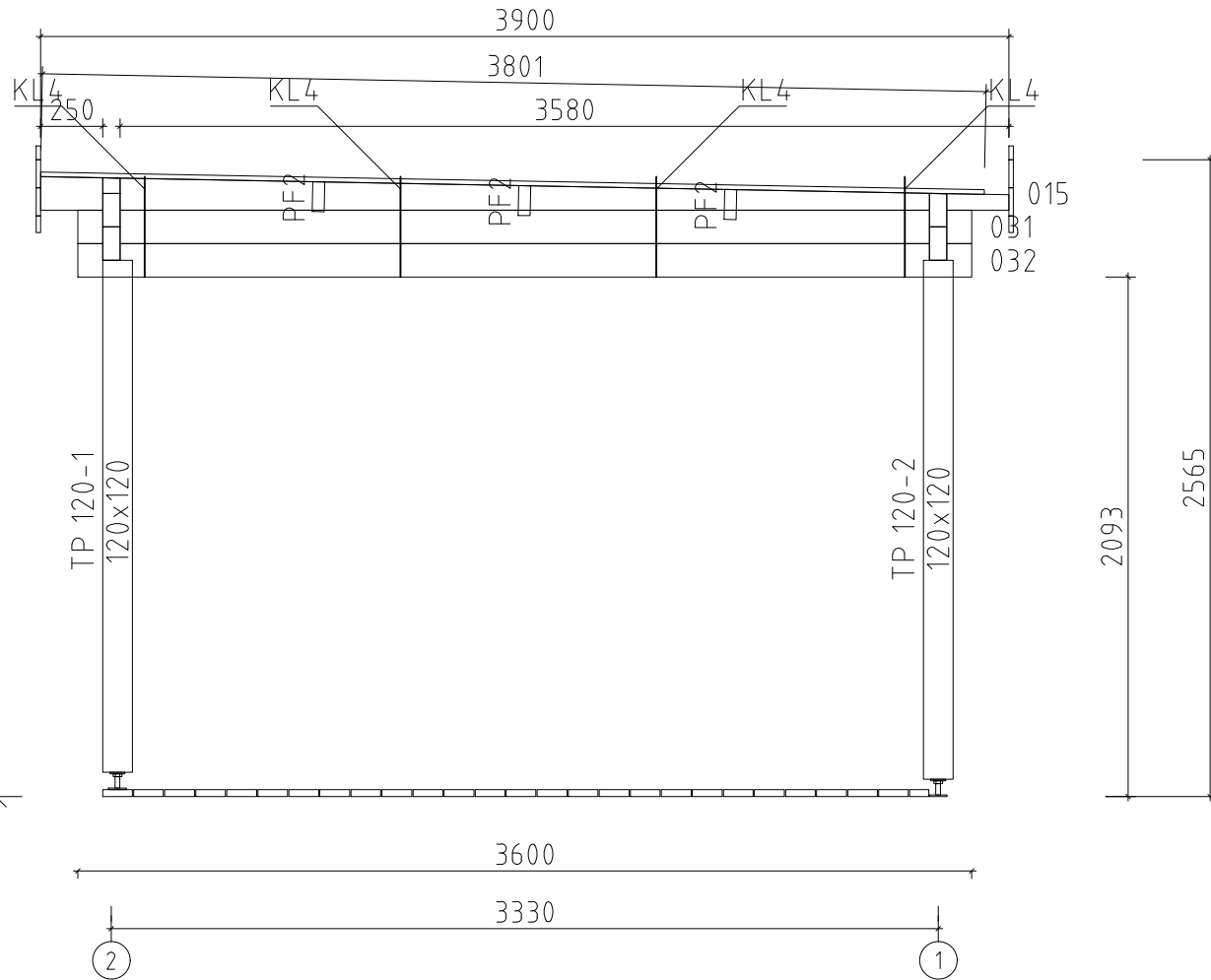

Wand/Wall A ↑

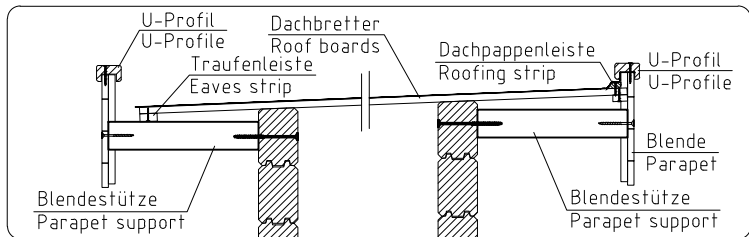

Name	Hansa Corner Sauna A 700x360+SD+Terr 70	
Zeichnung/Drawing	WAND/WALL A	
Profil/Profile	7.0x13.5	Datum/Date 03.03.2023

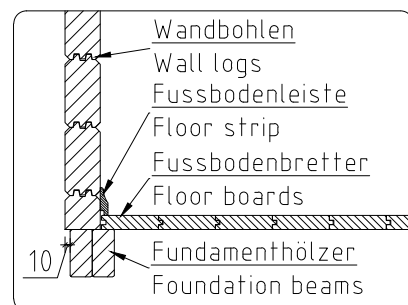
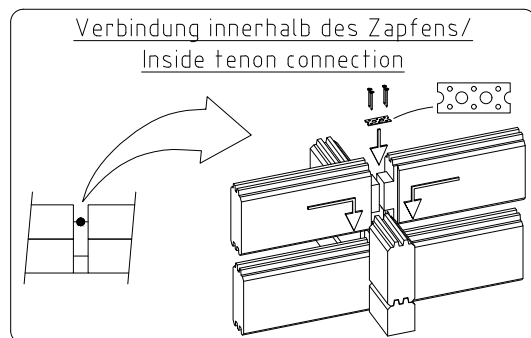
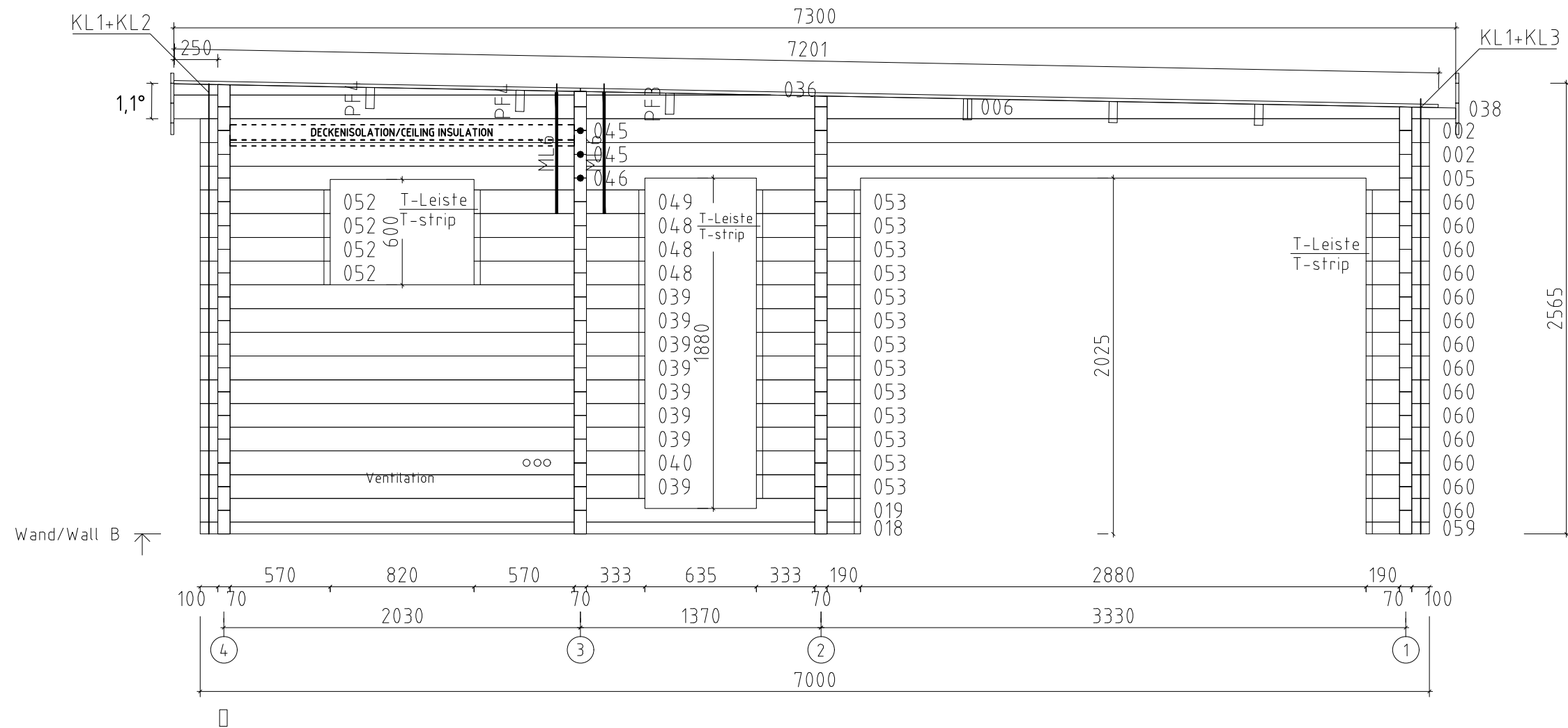

Die Bohlen mit Lüftungsöffnungen können je nach Bedarf höher oder niedriger eingesetzt werden. Bitte achten Sie darauf dass die Lüftungsöffnungen von innen nicht mit der Saunabank bedeckt werden!

Logs with ventilation holes can be placed higher or lower. Please make sure it doesn't get covered with sauna bench!

Name	Hansa Corner Sauna A 700x360+SD+Terr 70		
Zeichnung/Drawing	WAND/WALL B		
Profil/Profile	7.0x13.5	Datum/Date	03.03.2023

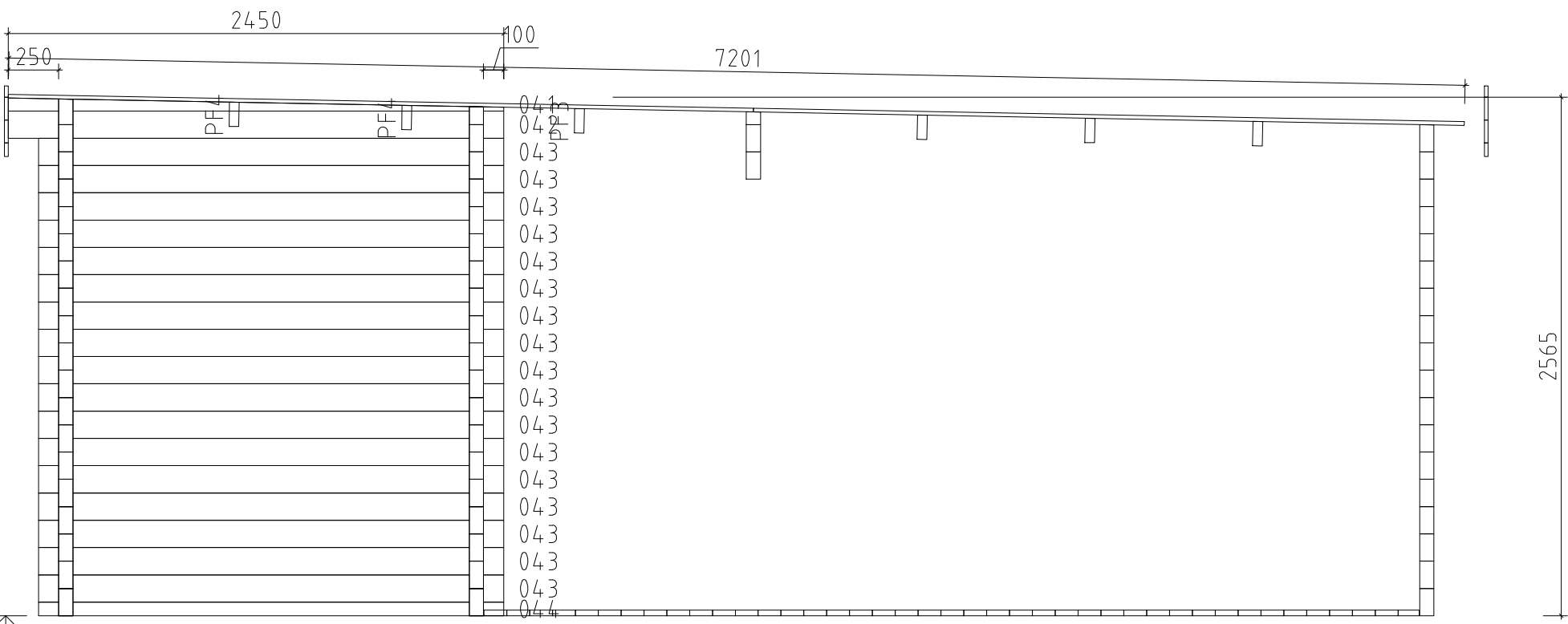

Wand/Wall C ↑

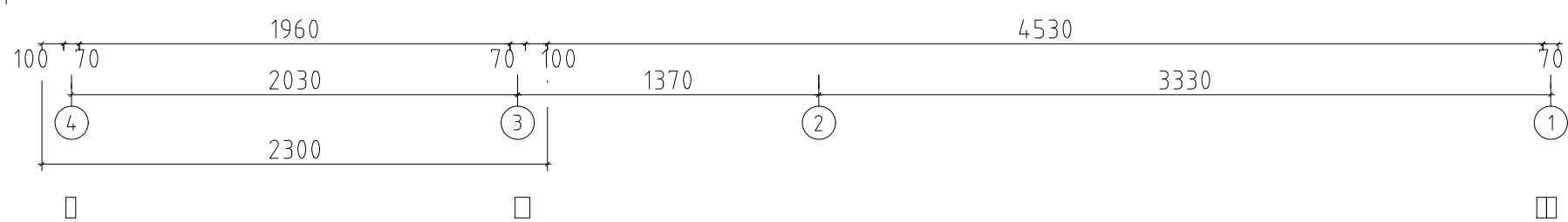

Name	Hansa Corner Sauna A 700x360+SD+Terr 70		
Zeichnung/Drawing	WAND/WALL C		
Profil/Profile	7.0x13.5	Datum/Date	03.03.2023

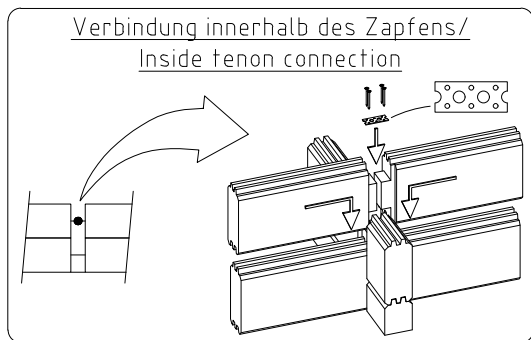
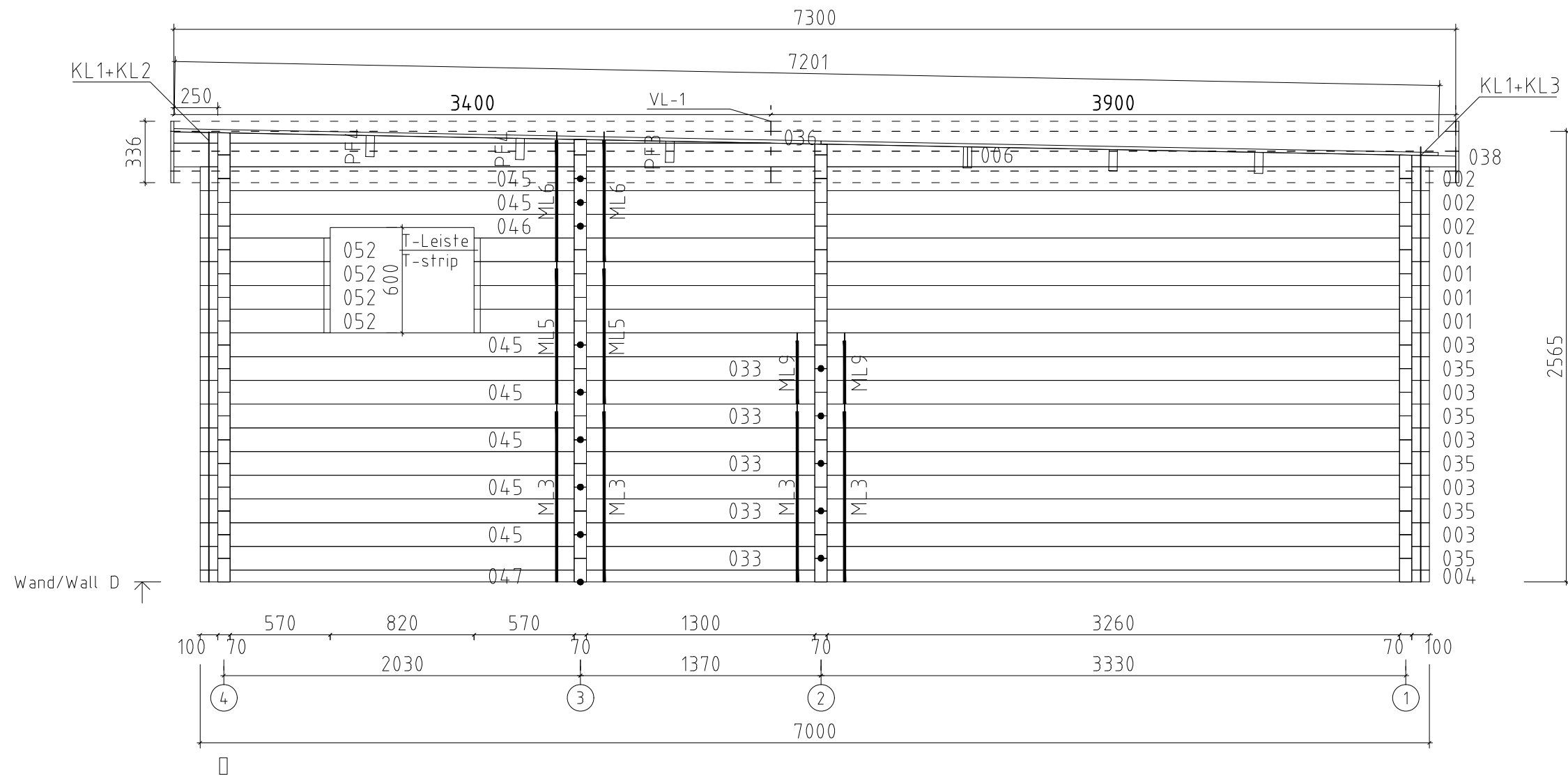

Name	Hansa Corner Sauna A 700x360+SD+Terr 70		
Zeichnung/Drawing	WAND/WALL D		
Profil/Profile	7.0x13.5	Datum/Date	03.03.2023

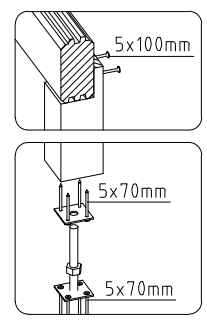
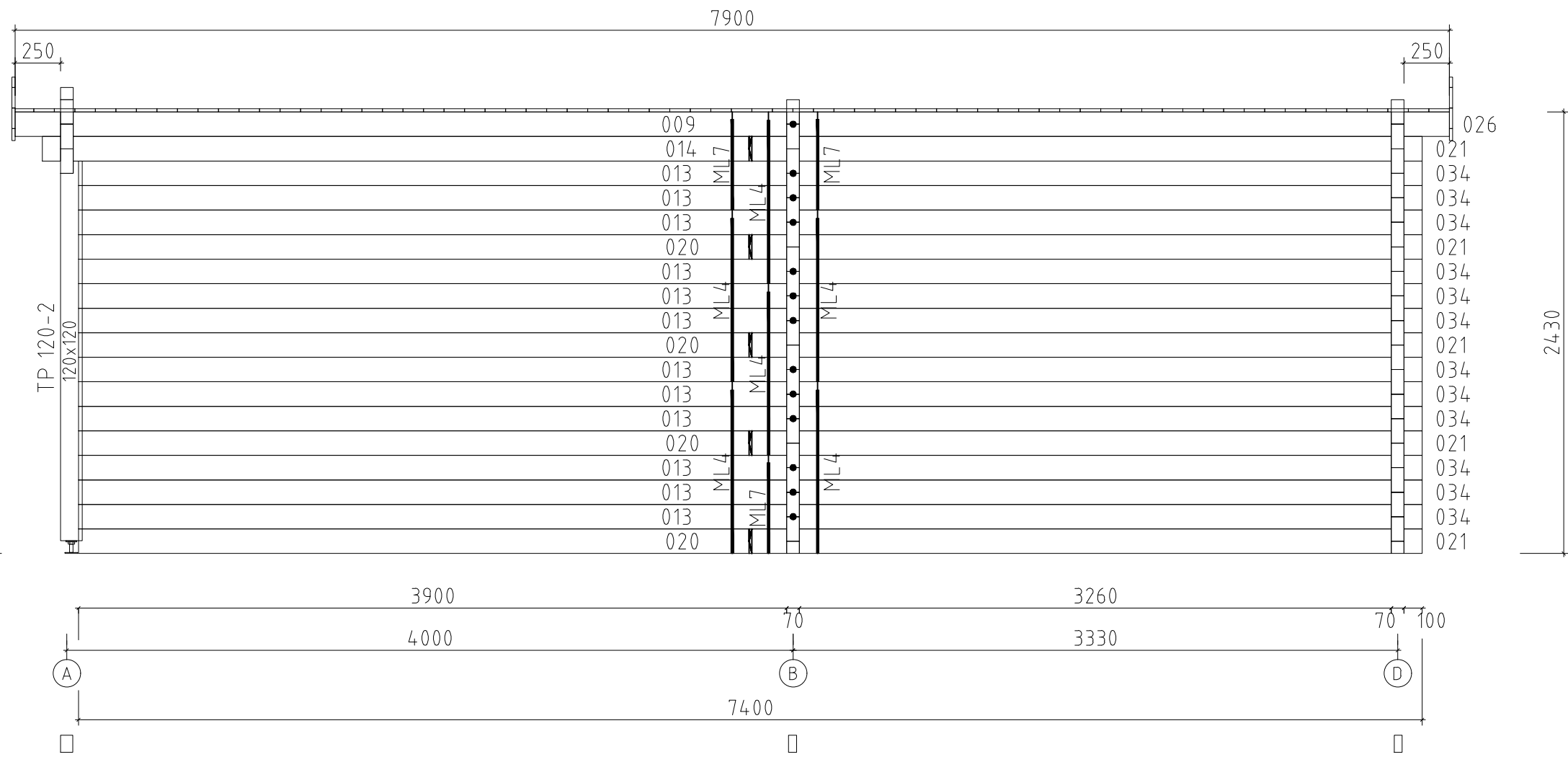

Wand/Wall 1 ↗

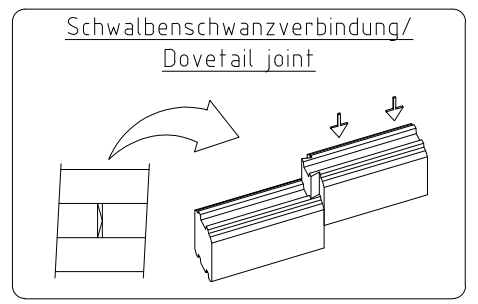
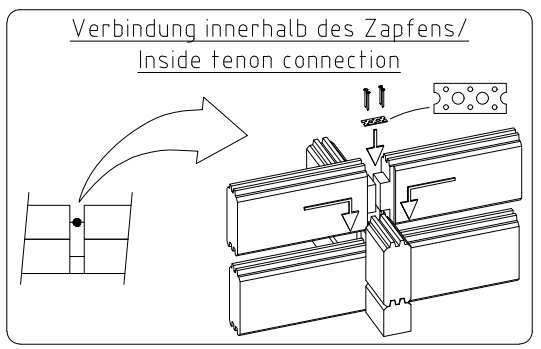

Name	Hansa Corner Sauna A 700x360+SD+Terr 70		
Zeichnung/Drawing	WAND/WALL 1		
Profil/Profile	7.0x13.5	Datum/Date	03.03.2023

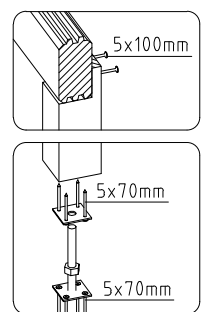

Wand/Wall 2 ↑

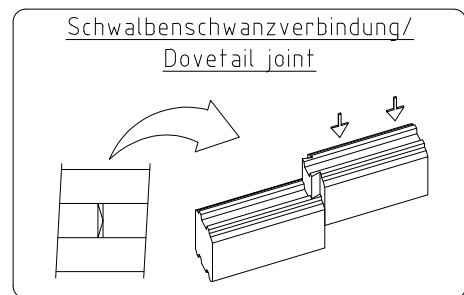
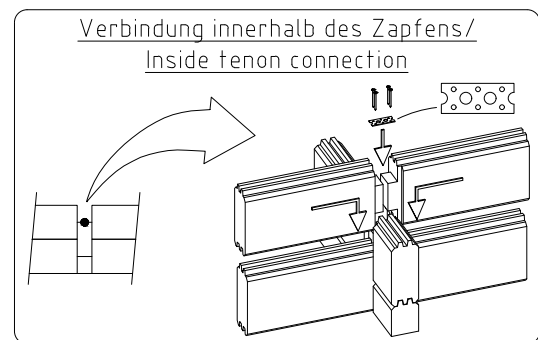
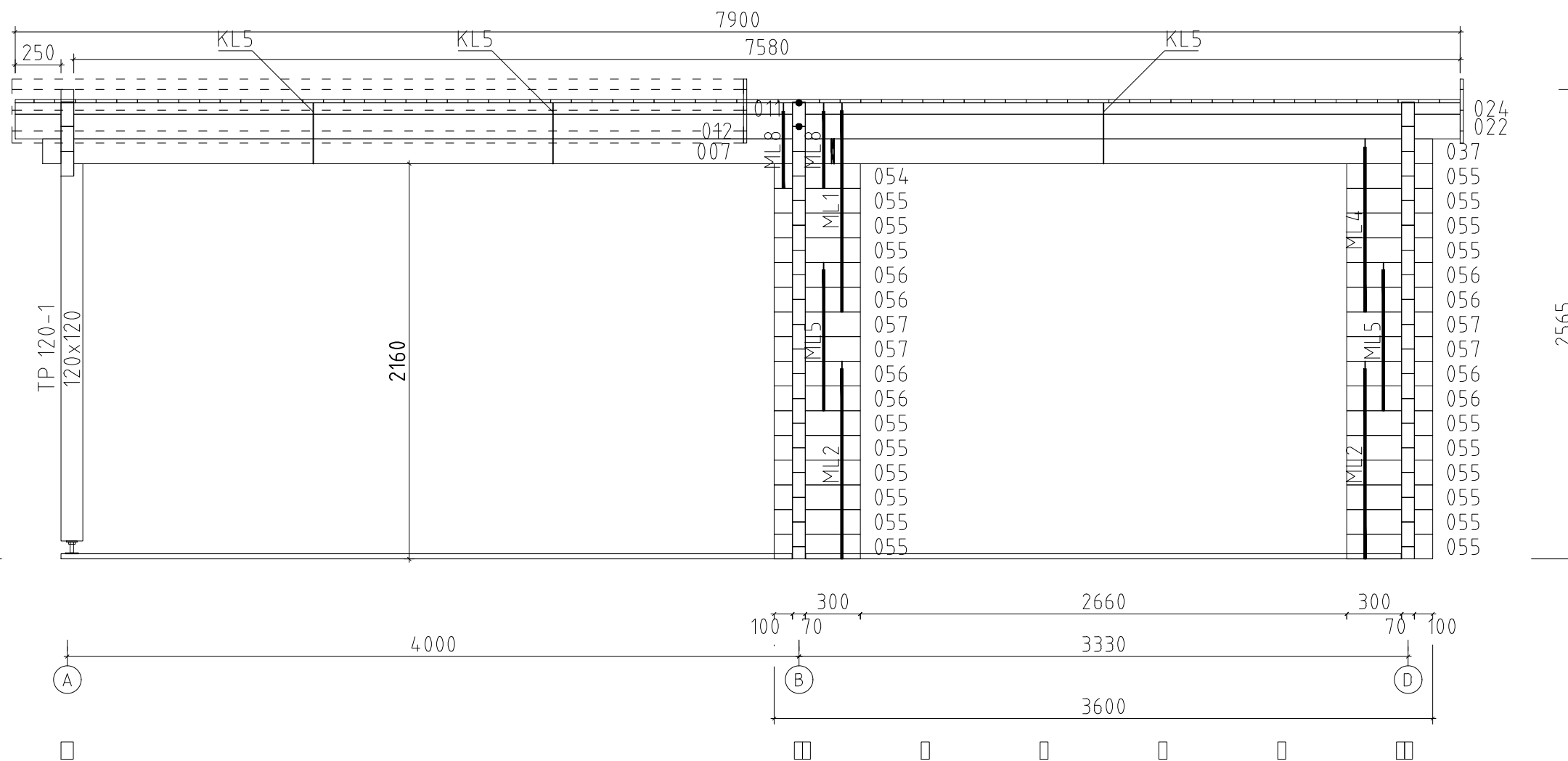

Name	Hansa Corner Sauna A 700x360+SD+Terr 70		
Zeichnung/Drawing	WAND/WALL 2		
Profil/Profile	7.0x13.5	Datum/Date	03.03.2023

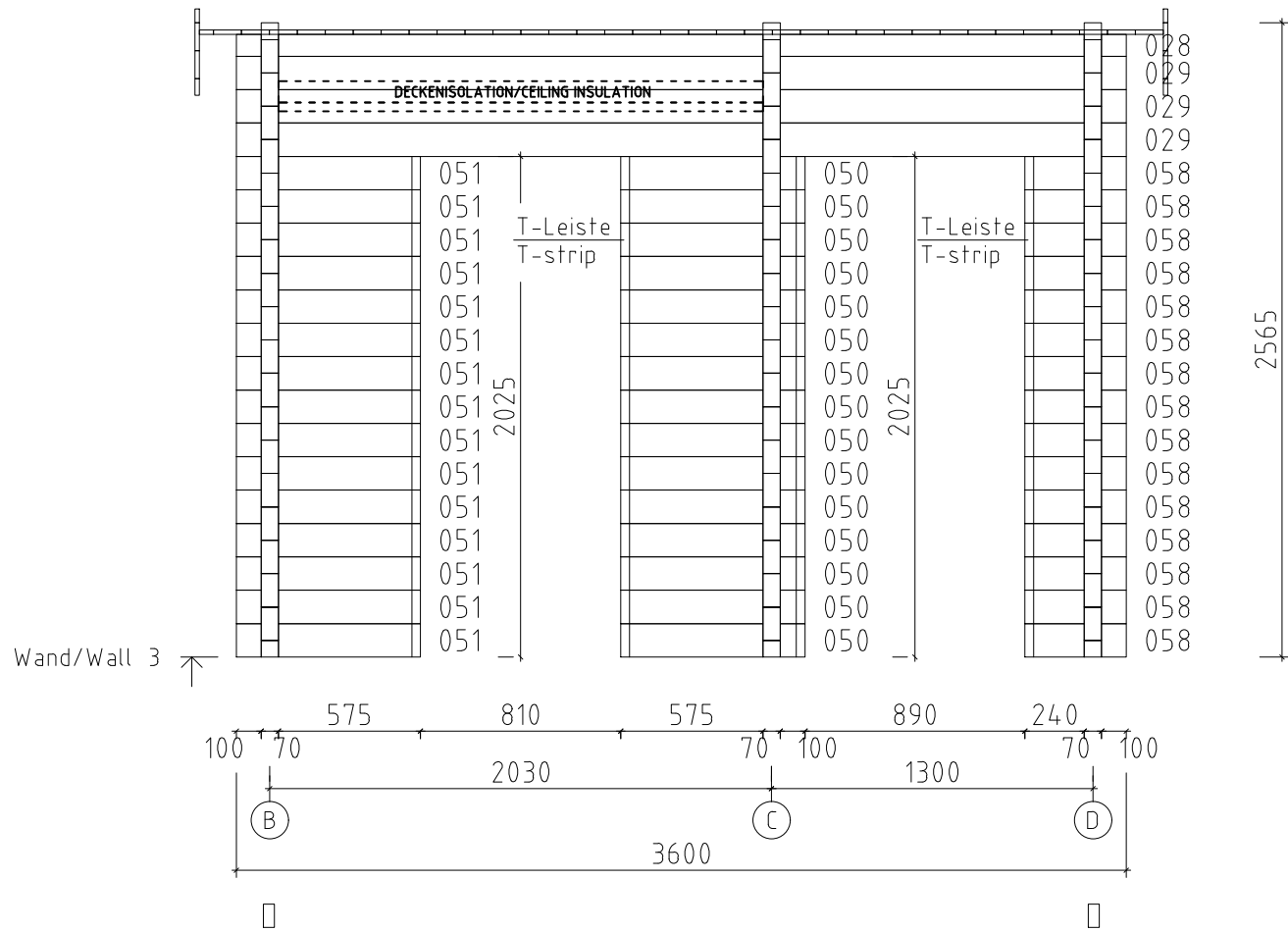

Name	Hansa Corner Sauna A 700x360+SD+Terr 70	
Zeichnung/Drawing	WAND/WALL 3	
Profil/Profile	7.0x13.5	Datum/Date 03.03.2023

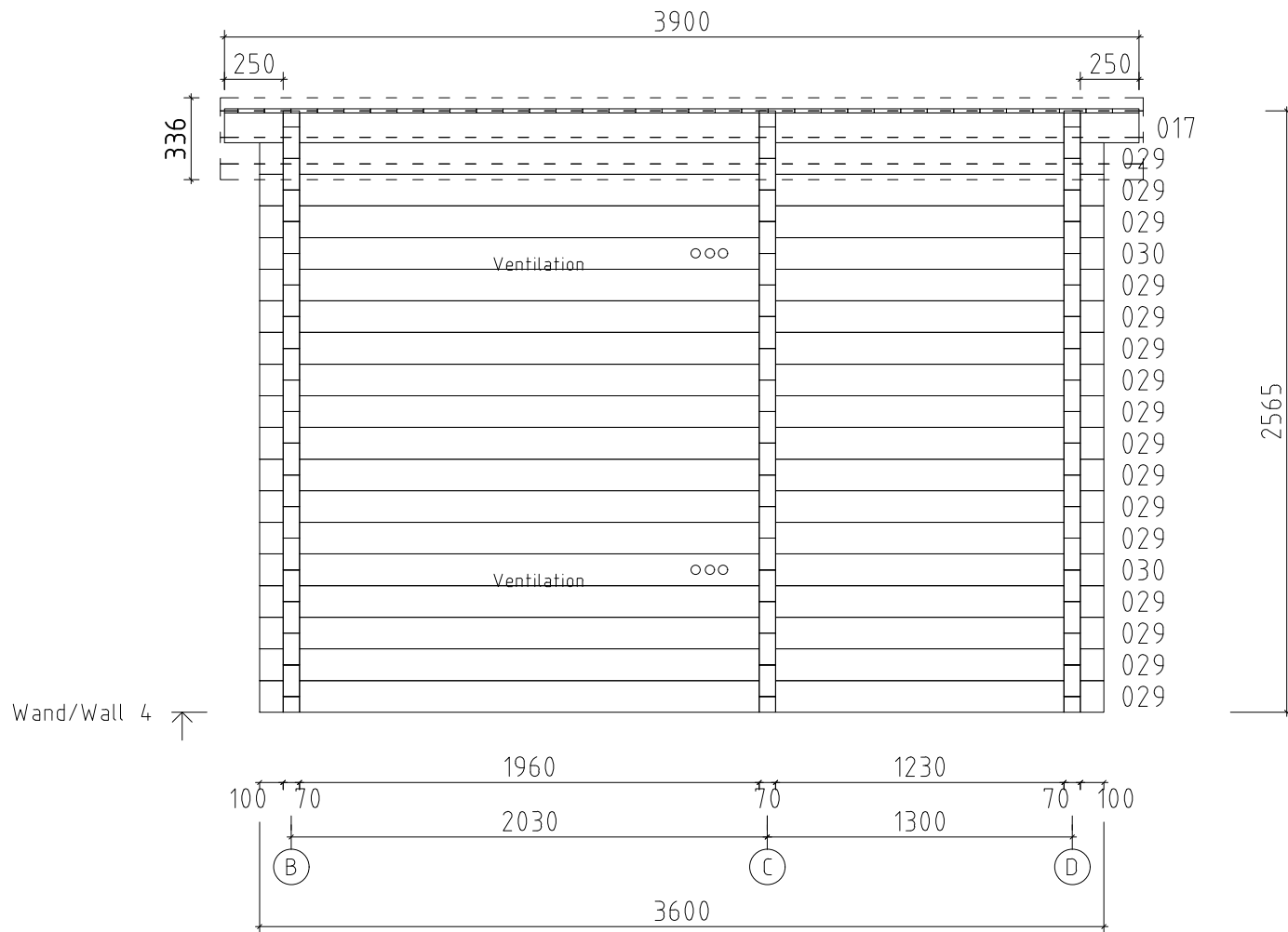

Wand/Wall 4 ↑

Die Bohlen mit Lüftungsöffnungen können je nach Bedarf höher oder niedriger eingesetzt werden. Bitte achten Sie darauf dass die Lüftungsöffnungen von innen nicht mit der Saunabank bedeckt werden!

Logs with ventilation holes can be placed higher or lower. Please make sure it doesnt get covered with sauna bench!

Name	Hansa Corner Sauna A 700x360+SD+Terr 70		
Zeichnung/Drawing	WAND/WALL 4		
Profil/Profile	7.0x13.5	Datum/Date	03.03.2023