

Name Hansa Garage A 320x575 44

Zeichnung/Drawing

3D

Profil/Profile 4.4x13.5

Datum/Date 13.03.2023

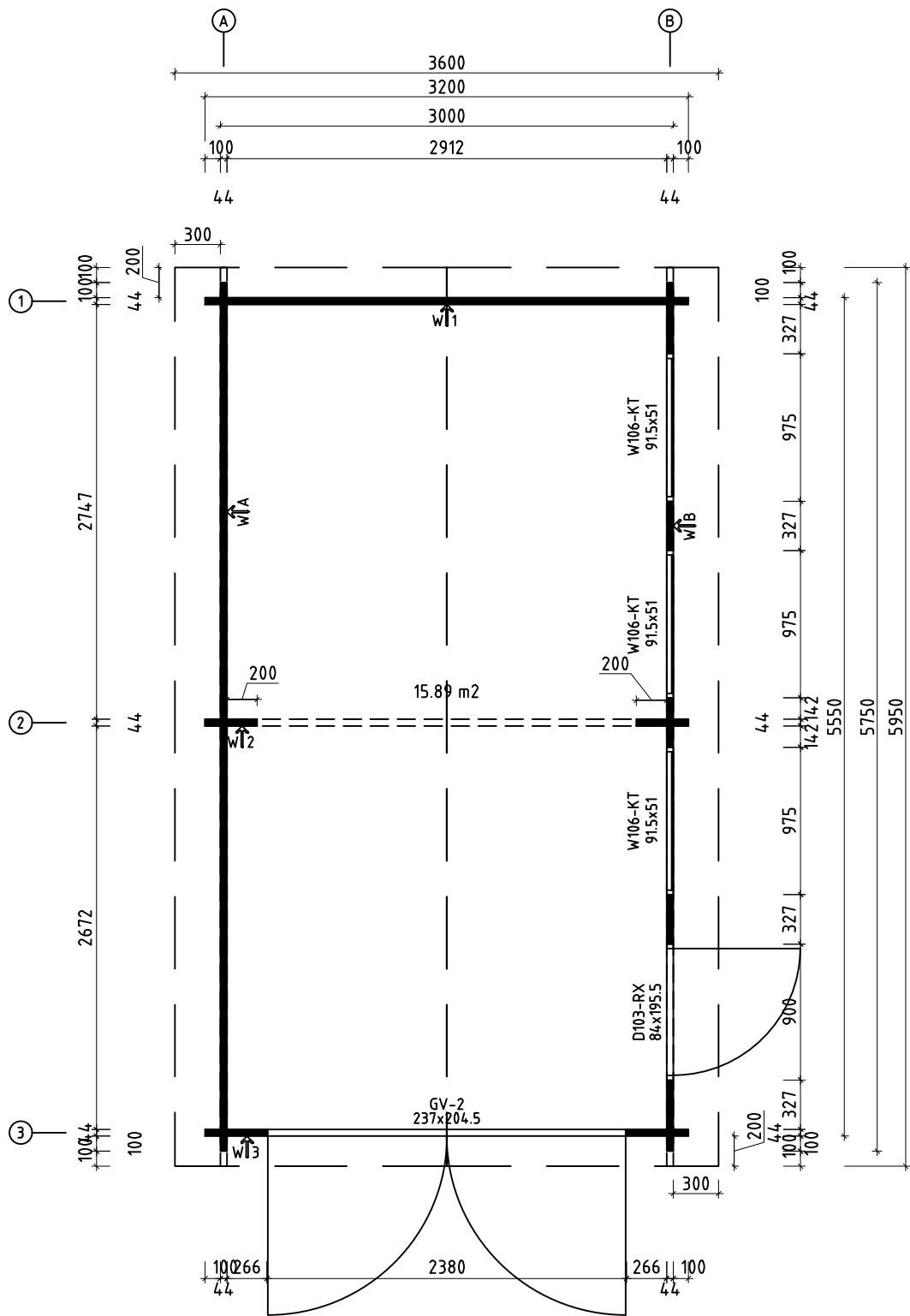





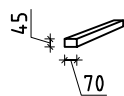
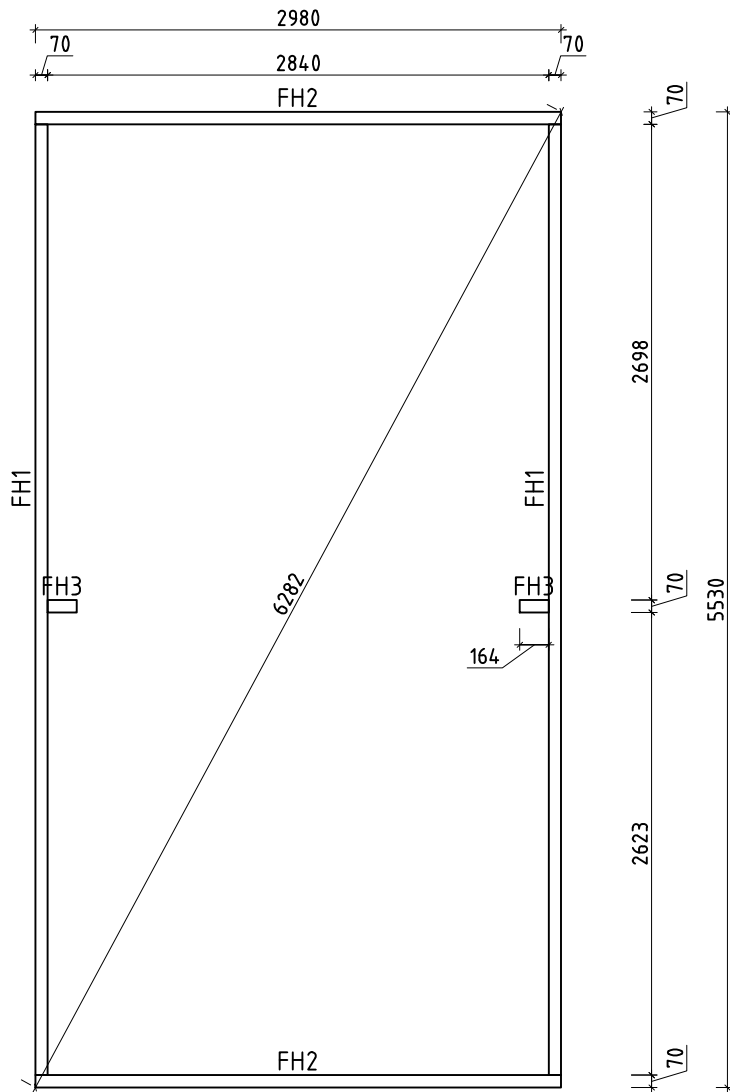



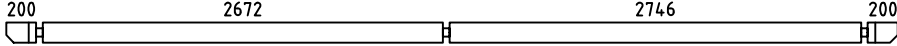
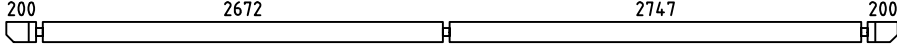
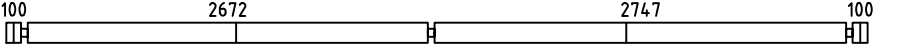
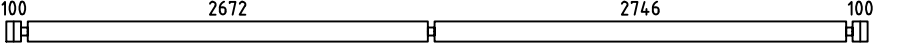
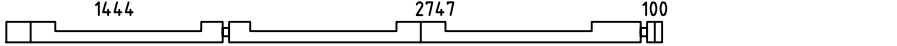
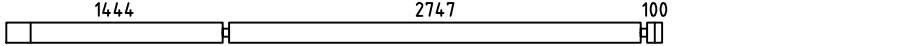
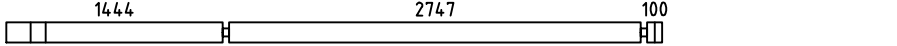
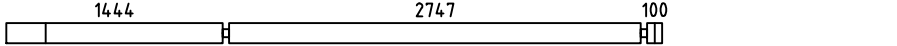
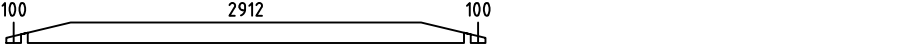
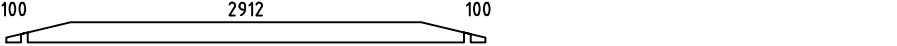
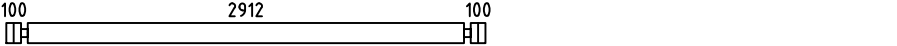
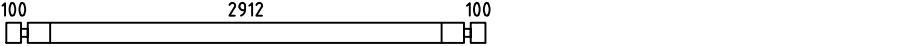
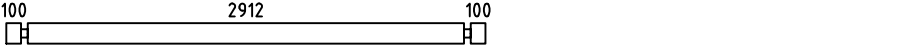
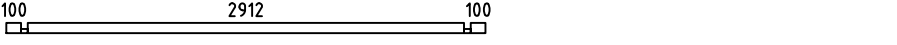













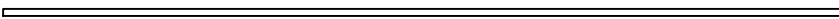

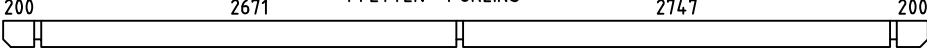
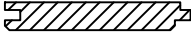

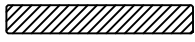
Q5 - Qualitätsklasse für Fenster und Türen/  
Quality class for windows and doors





Name	Hansa Garage A 320x575 44	
Zeichnung/Drawing	Grundplan, Plan	
Profil/Profile	4.4x13.5	Datum/Date 13.03.2023

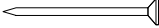

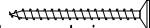
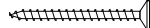
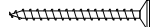
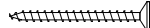
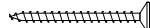
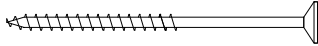
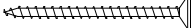

Name	Hansa Garage A 320x575 44	
Zeichnung/Drawing	Lagerholzplan, Foundation beams	
Profil/Profile	4.4x13.5	Datum/Date 13.03.2023

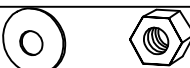
Pos	Teileliste/Specification Hansa Garage A 320x575 44	Stck. Pcs.	Profil Profile (mm)	Länge Length (mm)
000		1	44x135	5950
001		1	44x135	5950
002		1	44x135	5950
003		1	44x135	5750
004		16	44x135	5750
005		1	44x135	4379
006		1	44x135	4379
007		2	44x135	4379
008		7	44x135	4379
009		1	44x135	3200
010		2	44x135	3200
011		1	44x135	3200
012		1	44x135	3200
013		16	44x135	3200
014		1	44x68	3200
015		3	44x135	2341
016		6	44x135	576
017		19	44x135	471
018		2	44x68	410
019		30	44x135	410
020		12	44x135	344
021		4	44x135	344
022		14	44x135	344
023		2	44x68	344
024		4	44x135	327
025		8	44x135	327

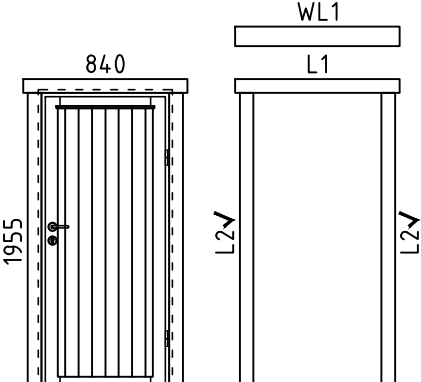
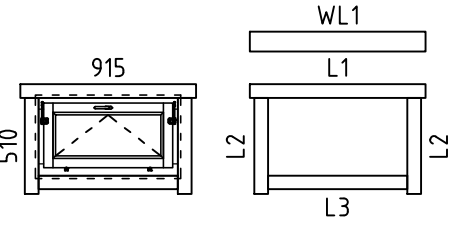
Pos	Teilleiste/Specification Hansa Garage A 320x575 44		Stck. Pcs.	Profil Profile (mm)	Länge Length (mm)
FH1	FUNDAMENTHOLZ (imprägniert) - FOUNDATION BEAM (impregnated) 		2	70x45	5390
FH2	FUNDAMENTHOLZ (imprägniert) - FOUNDATION BEAM (impregnated) 		2	70x45	2980
FH3	FUNDAMENTHOLZ (imprägniert) - FOUNDATION BEAM (impregnated) 		2	70x45	164
PF1	PFETTEN - PURLINS 		3	58x170	5950
	DACHBRETTER - ROOF BOARDS 		106+2	113x18	1850
	DECKENLEISTEN - CEILING STRIPS  ✓			15x28	35.0 lfm/rm
G02-1	GIEBELBRETTER - GABLE BOARDS 18x120 13.3°  ✓		4	18x120	1930
G06-1	GIEBELDECKLEISTEN - GABLE COVER STRIPS 18x58  ✓		4	18x58	1930
T01-1	TRAUFENBRETTER - EAVES BOARDS 18x95 		2	18x95	5950
T06-1	TRAUFENLEISTEN - EAVES STRIPS 18x40  ✓			18x40	12.0 lfm/rm
GS	GIEBELSEGMENT - GABLE DIAMOND 		2		
SH	SCHLAGHÖLZER - MOUNTING PIECES 		3		
ML1	Metallstange - Metal bar 		2	D10	1240
ML2	Metallstange - Metal bar 		4	D10	1170
ML3	Metallstange - Metal bar 		1	D10	770
NG2 550	NÄGEL - NAILS 2.5x50 Dachbretter - Roof boards 		636		
SR3 030	Schrauben - Screws 3.0x30 Deckenleisten - Ceiling strips 		50		
SR3 030	Schrauben - Screws 3.0x30 Traufenleisten - Eaves strips 		24		
SR37	Schrauben - Screws 3.5x45 Fenster- und Türleisten - Window and door strips 		82		
SR3 545	Schrauben - Screws 3.5x45 Giebelbretter - Gable boards 		16		
SR3 545	Schrauben - Screws 3.5x45 Giebeldeckleisten - Gable cover strips 		16		
SR3 545	Schrauben - Screws 3.5x45 Giebelsegment - Gable diamond 		4		
SR3 545	Schrauben - Screws 3.5x45 Traufenbretter - Eaves boards 		24		
SR5 0100	Schrauben - Screws 5.0x100 Fundamenthölzer - Foundation beams 		24		
SR44	Schrauben - Screws 4.0x60 Wasserleisten - Rain strips WL1 		12		
Kood	Hansa Garage A 320x575 44 Material		File	Hansa Garage A 320x575 44 4/4 2/4	

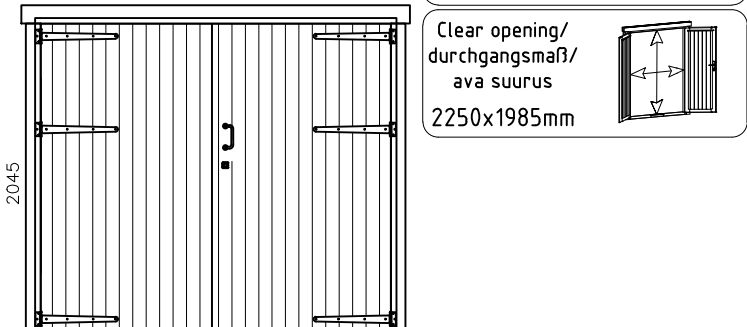
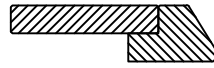
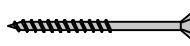
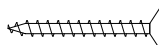
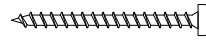
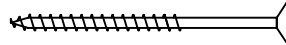
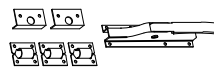
Pos	Teileliste/Specification Hansa Garage A 320x575 44	Stck. Pcs.	Profil Profile (mm)	Länge Length (mm)
KL1	Gewindestange - Threaded Rod M8 	6		2000
KL2	Gewindestange - Threaded Rod M8 	2		393
KL3	Gewindestange - Threaded Rod M8 	4		325
	Mutter - nut M8 U-Scheibe - washer Ø25 	12		
	Befestigungsmutter - fixing nut M8 	6		
	<p>TÜR/DOOR 840x1955 Q5 D5-S44R-XXX-08401955</p>  <p>D103-RX</p> <p>L1 18x90 L=1080mm 2x L2 18x90 L=1955mm 4x ✓ WL1 36x129 L=1080mm 1x DIN rechts/right handed</p>	1		
	<p>FENSTER/WINDOW 915x510 Q5 W5-S44K-0XT-09150510</p>  <p>W106-KT</p> <p>L1 18x90 L=1155mm 2x L2 18x90 L=630mm 4x L3 18x90 L=915mm 2x ✓ WL1 36x129 L=1155mm 1x</p>	3		
Kood	Hansa Garage A 320x575 44	Material	File	Hansa Garage A 320x575 44
				3/4

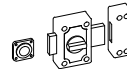
Pos	Teieliste/Specification Hansa Garage A 320x575 44	Stck. Pcs.	Profil Profile (mm)	Länge Length (mm)	
	<p>TÜR/DOOR 2370x2045 D0-V44R-XXX-23702045</p> <p>GV-2 2370</p>  <p>Right handed / DIN rechts / paremakäeline</p> <p>Clear opening/ durchgangsmaß/ ava suurus 2250x1985mm</p>	1			
WL-1	Rain strips - Wasserleisten - Vihmaliistud 36x134		1	36x134	2550
SR40 62-01	4.0x60 C3 Rain strip - Wasserleiste - Vihmaliist		6		
SR50 50-01	5.0x50 GV Handle - Handgriff - Käepide		4		
SR50 62-01	5.0x60ÜP GV Hinges - Türbänder - Uksehinged		24		
SR50 90-01	5.0x90 Door frames - Türrahmen - Ukselengid		4		
GV-FX	GV Fixator - Fixator - Fiksaator		1		
GV- FXV	GV Fixator rods - Fixierstäben - Fiksaatori vardad		1		
GV-KP	GV Handle - Handgriff - Käepide		1		
GV-PL	GV Surface lock - Kastenschloss - Pindlukk		1		
	<b>Achtung!</b> Die Giebelbohlen können teilweise schon vormontiert sein! Bitte beachten - diese erscheinen nicht ganz so wie in der Teieliste beschrieben.				
	<b>Notice!</b> The gable pieces can be partly pre-assembled! Please notice - those differ from the description given in the specification list.				
	✓ - Bitte selber anpassen (falls nötig)! / Cut into length on site (if needed)!				
Kood	Hansa Garage A 320x575 44	Materjal	File	Hansa Garage A 320x575 44	4/4

Aken	Q4-Q6	-	paigaldusjuhis
Window	Q4-Q6	-	assembly instructions
Fenster	Q4-Q6	-	Montageanleitung

5-10mm

3.5x45

Lõika mõõtu  
Cut to length  
Absägen  
- 10mm / -20mm

**NB!**

3.5x45



Vihmaliist / Rain strip / Wasserleiste

Q5-Q6

\*Silikoon  
\*Silicon  
\*Silikon

\*Vajumispilu  
\*Settling gap  
\*Senkungs spalt

ca 40-50mm

NB!

- Monteerida juhul kui ese on välja toodud maja spetsifikatsioonis!
- Install only if the item is listed in the house specification!
- Nur montieren wenn die Leiste in der Teileliste gezeigt ist!

Veeplekk / Window sill / Fensterbank

4,2x16

Ukse montaaž / Tür montage / Door assembly  
(GH+ / SH)

4.5x90

4.5x90

5mm

3.5x45



## Vihmaliist / Head flashing / Regenschutz

Silikoon  
Silicon  
Silikon

Vajumispilu  
Settling gap  
Senkungs spalt  
40-50mm

### NB!

- Monteerida juhul kui ese on välja toodud maja spetsifikatsioonis!
- Install only if the item is listed in the house specification!
- Nur montieren wenn die Leiste in der Teilleiste gezeigt ist!

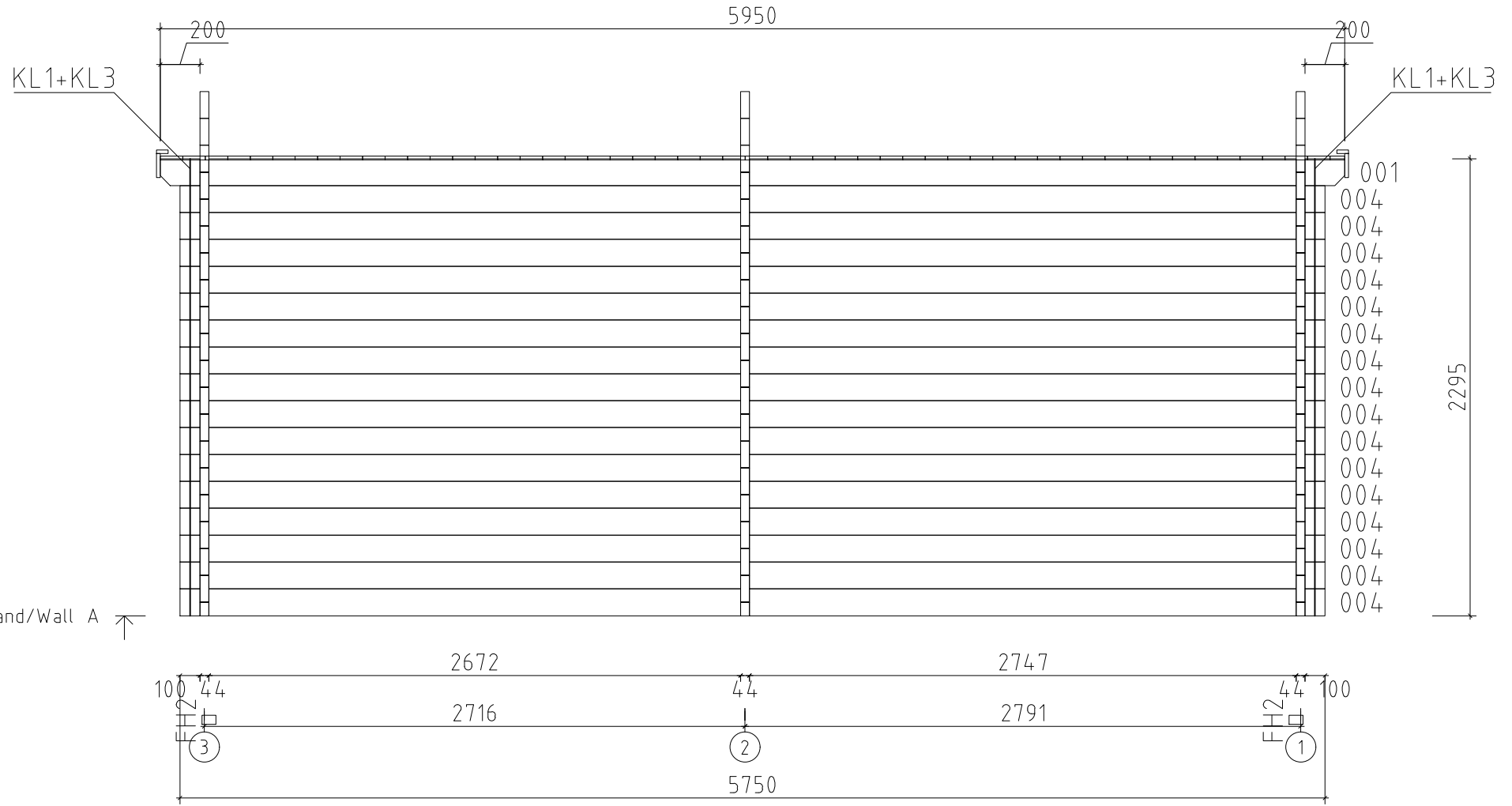

- Giebeldeckleisten
- Gable cover boards
- Dachbretter
- Roof boards
- Giebelbretter
- Gable boards
- Pfetten/Wandbohlen
- Purlins/Wall log

Name	Hansa Garage A 320x575 44	
Zeichnung/Drawing	WAND/WALL A	
Profil/Profile	4.4x13.5	Datum/Date 13.03.2023

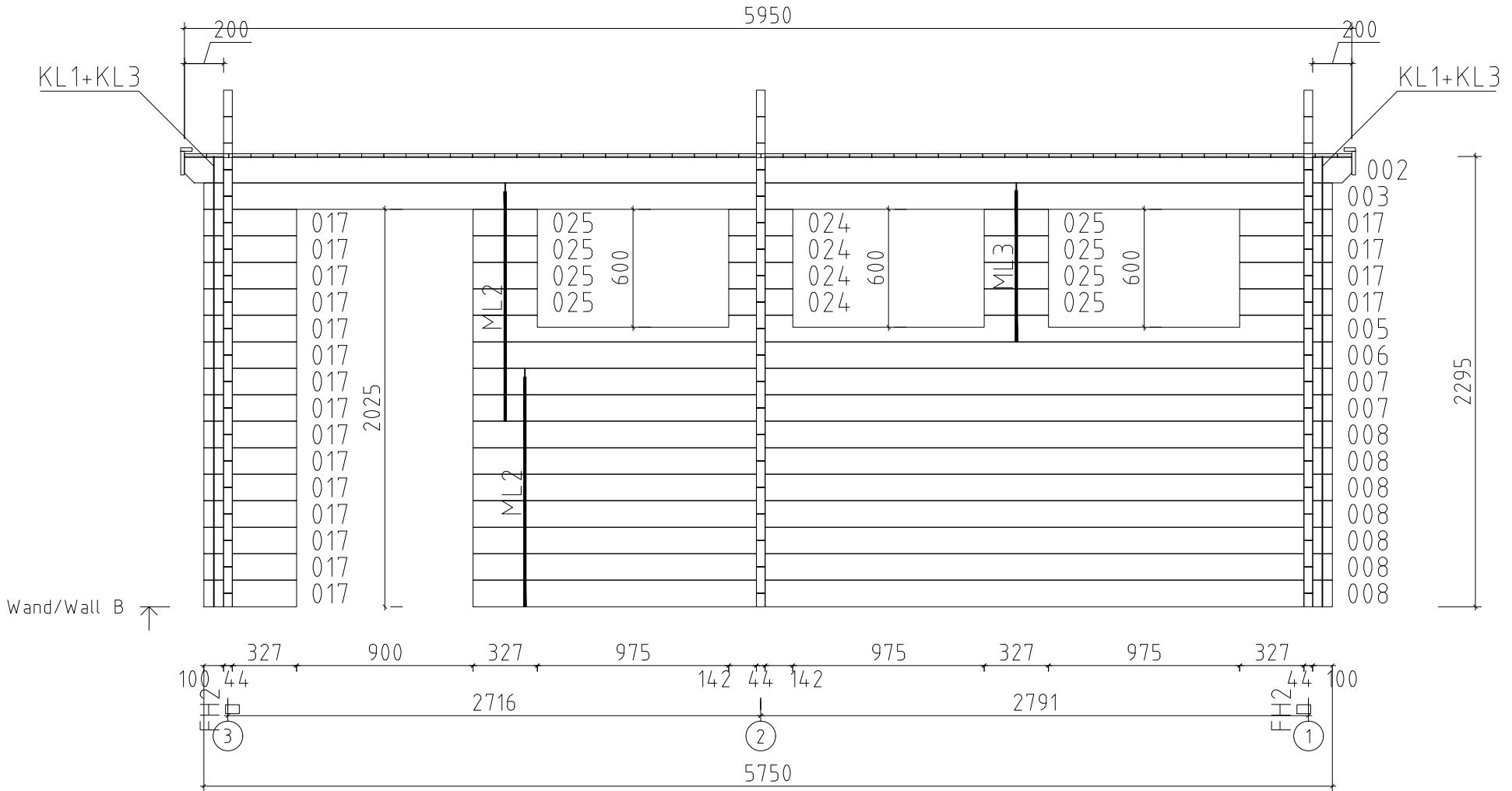

Name	Hansa Garage A 320x575 44	
Zeichnung/Drawing	WAND/WALL B	
Profil/Profile	4.4x13.5	Datum/Date
		13.03.2023

- Dachbretter
- Roof boards
- Traufenbretter
- Gable boards
- Traufenleisten
- Eaves strips

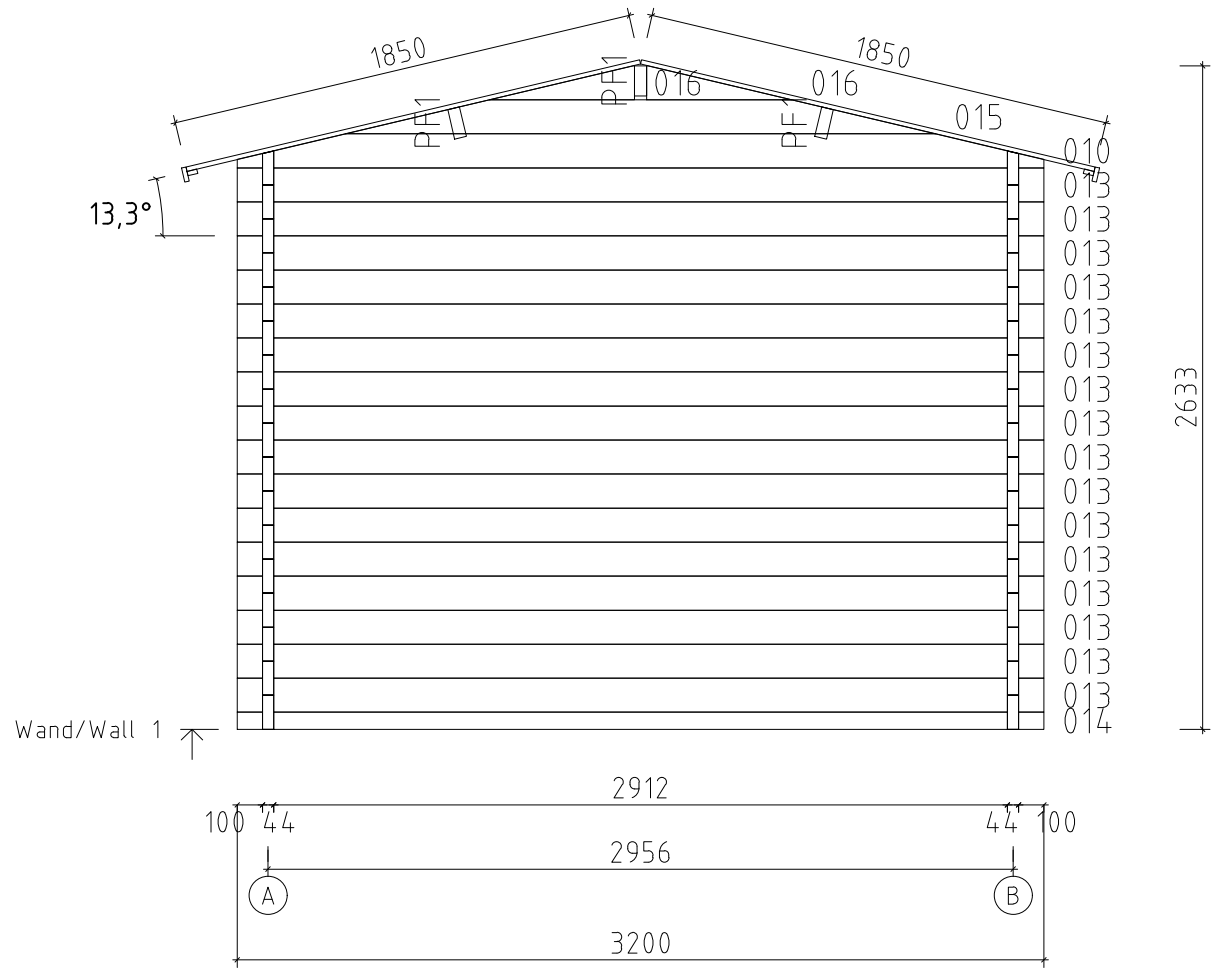

- Wandbohlen
- Wall logs
- Fundamenthölzer
- Foundation beams

Name	Hansa Garage A 320x575 44		
Zeichnung/Drawing	WAND/WALL 1		
Profil/Profile	4.4x13.5	Datum/Date	13.03.2023



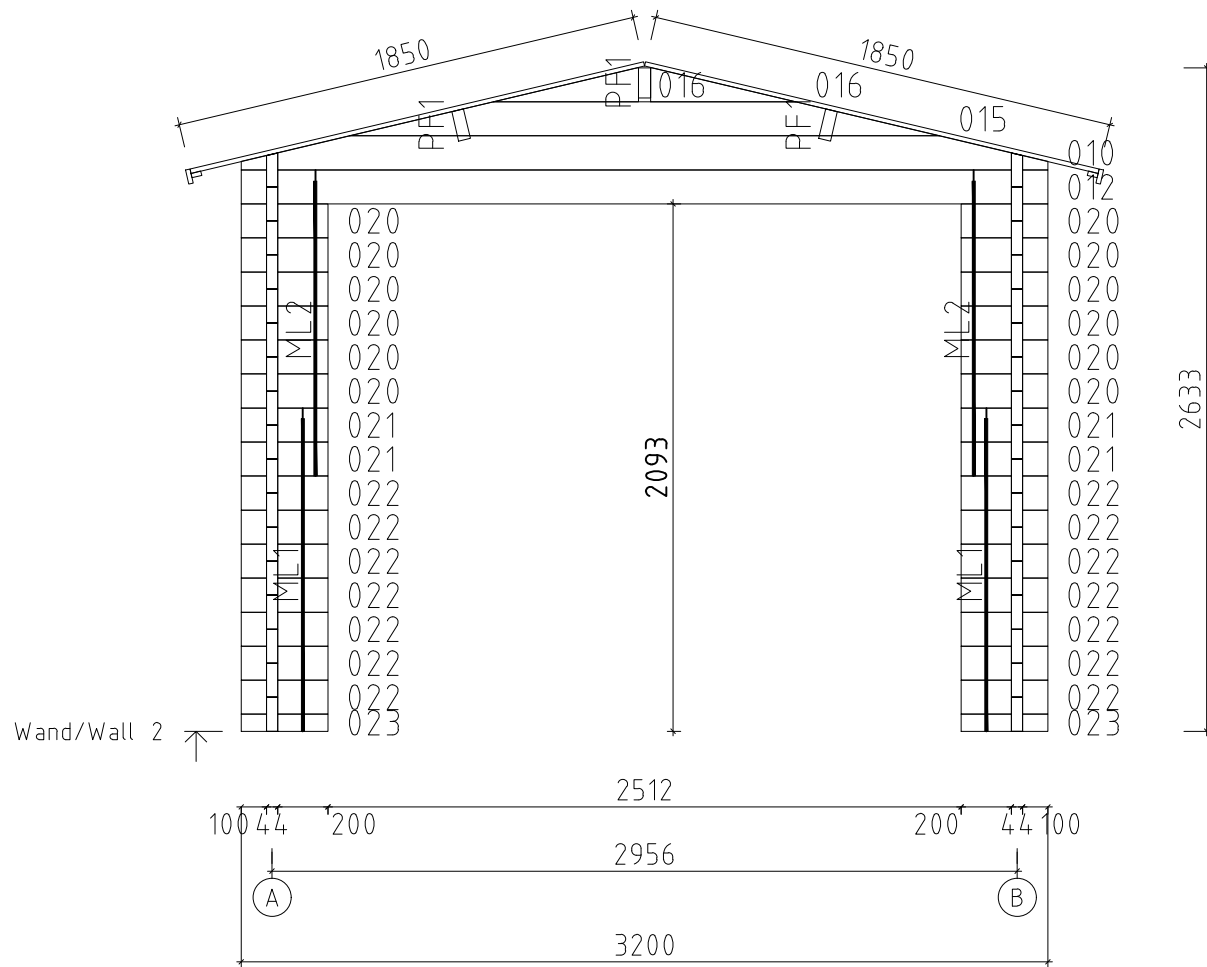

Wand/Wall 2 ↗

Name	Hansa Garage A 320x575 44		
Zeichnung/Drawing	WAND/WALL 2		
Profil/Profile	4.4x13.5	Datum/Date	13.03.2023

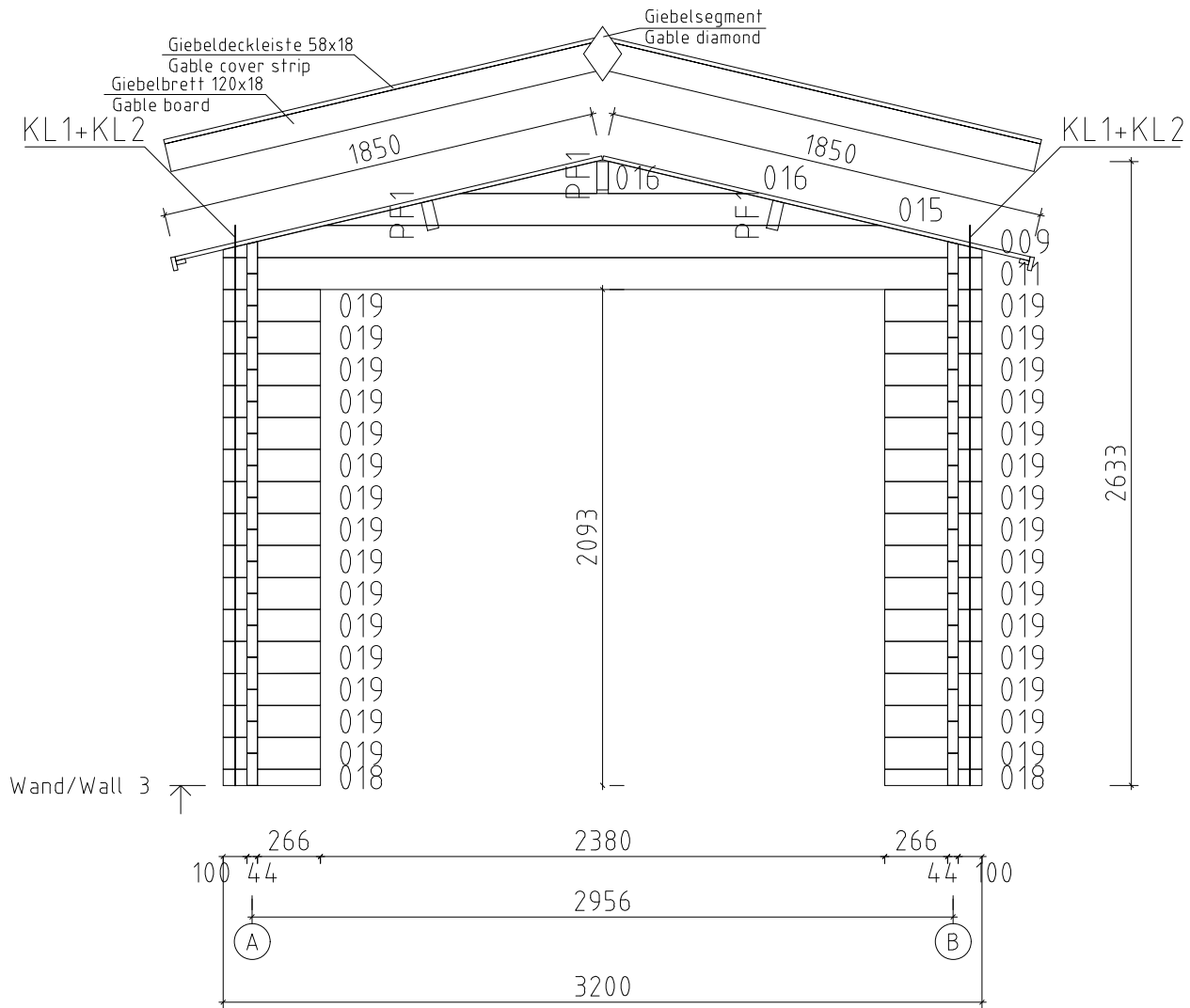

Name	Hansa Garage A 320x575 44		
Zeichnung/Drawing	WAND/WALL 3		
Profil/Profile	4.4x13.5	Datum/Date	13.03.2023