

Name

Hansa Garage Deluxe B 470x575; 70

Zeichnung/Drawing

3D

Profil/Profile

7.0x13.5

Datum/Date

30.03.2022

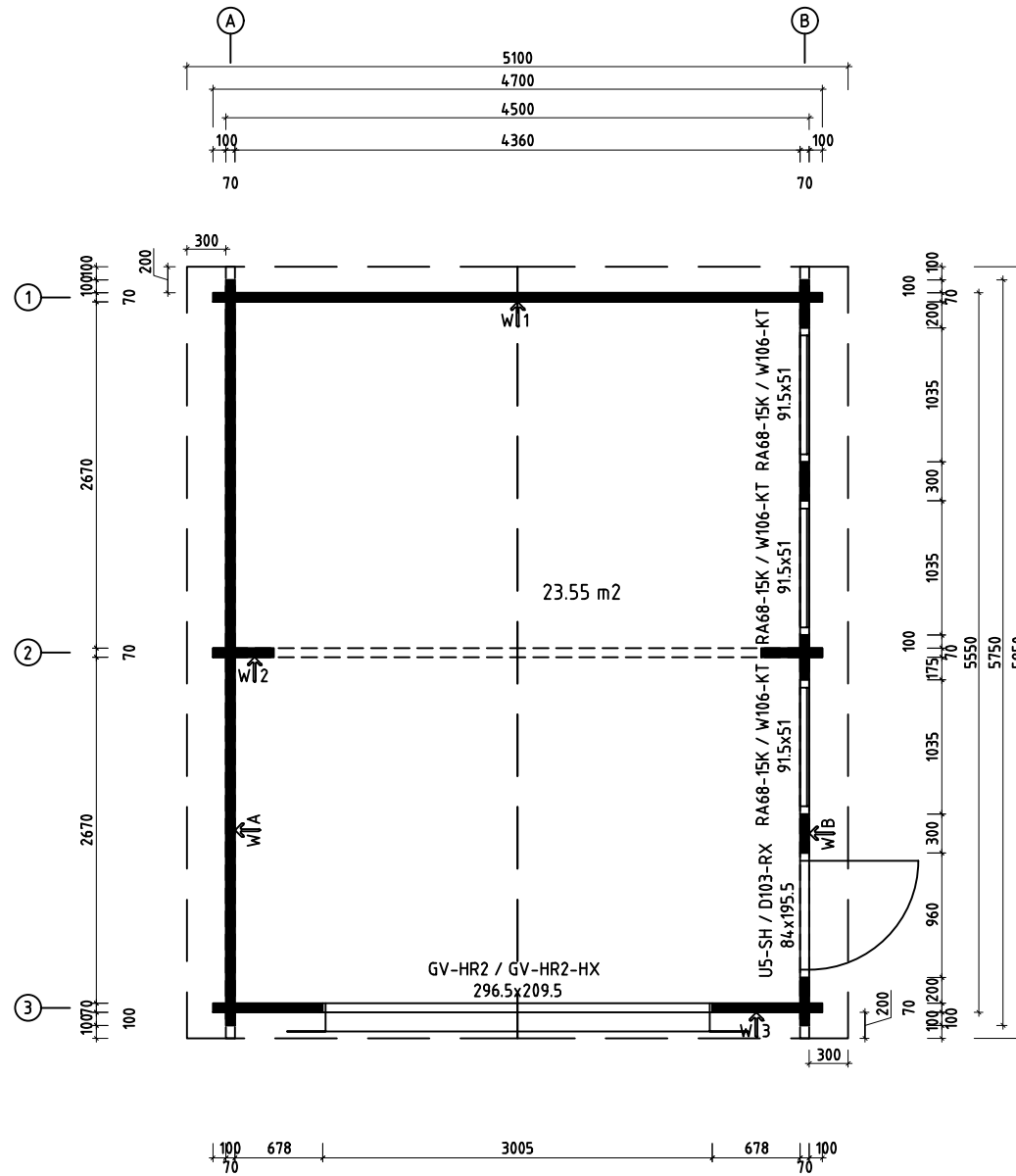





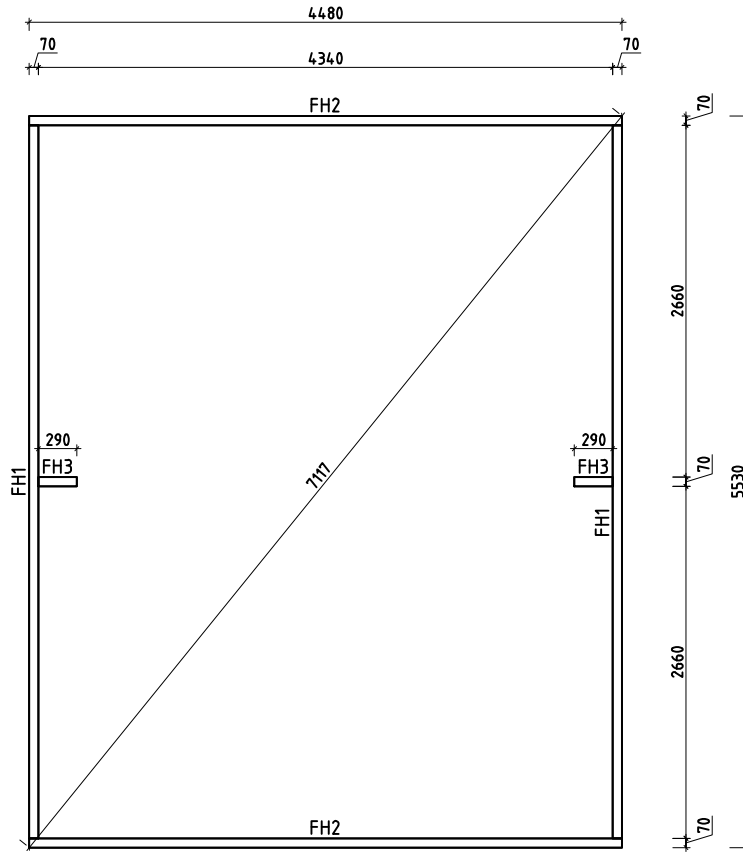



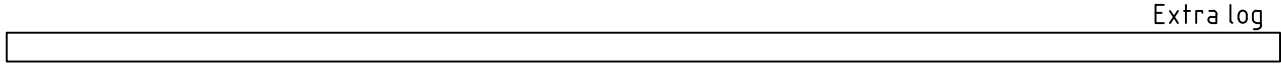
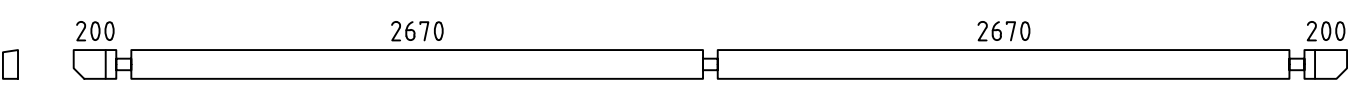
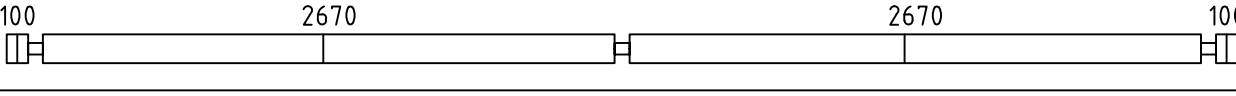
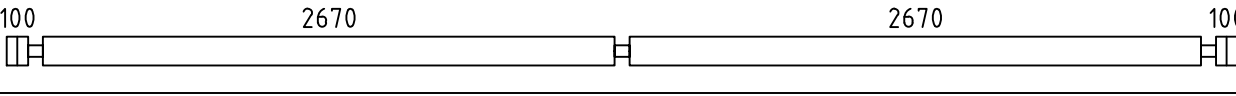
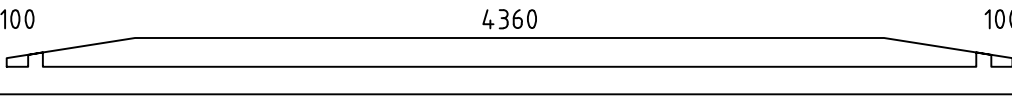
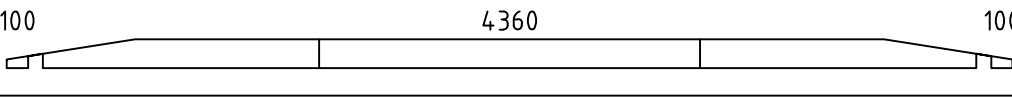
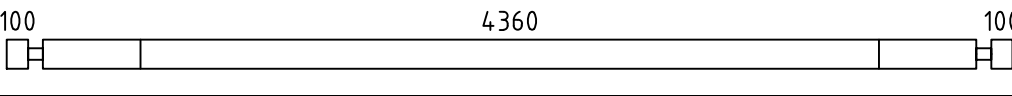
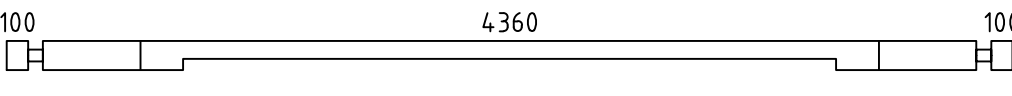
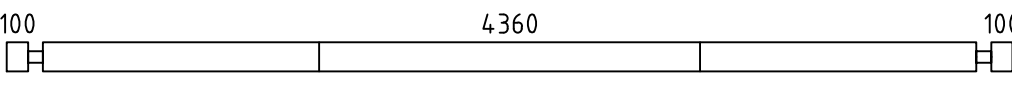
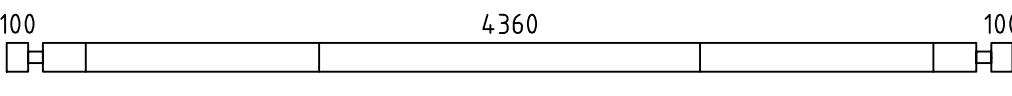
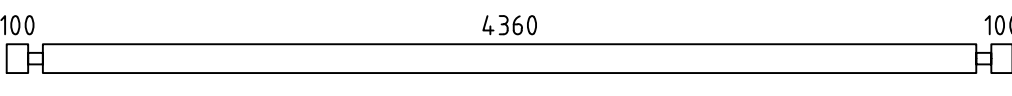
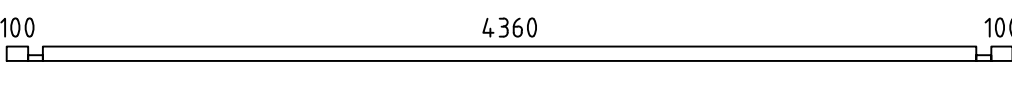
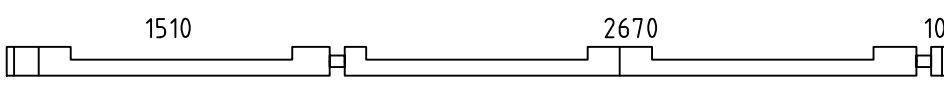
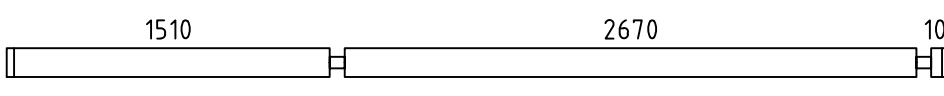
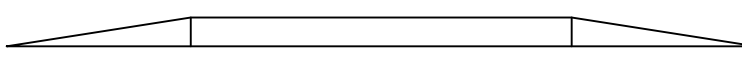
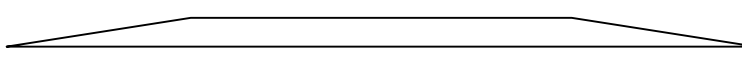
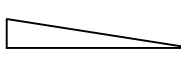
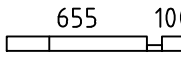
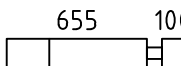
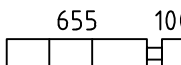
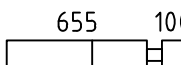
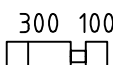
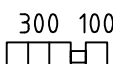
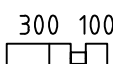
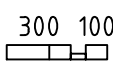
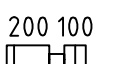



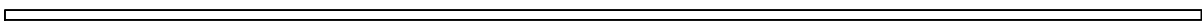

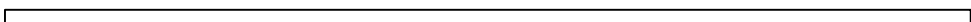
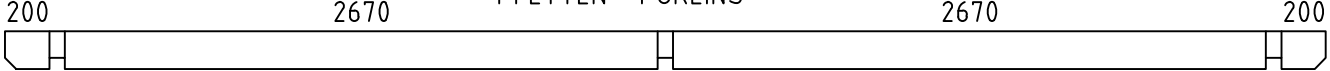
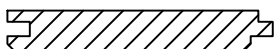

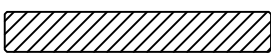

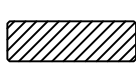
Q5 - Qualitätsklasse für Fenster und Türen/
Quality class for windows and doors

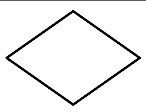

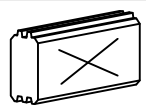
Name	Hansa Garage Deluxe B 470x575; 70		
Zeichnung/Drawing	Grundplan, Plan		
Profil/Profile	4.0	7.0x13.5	Datum/Date A3 30.03.2022







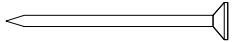
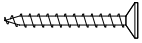
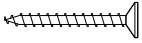
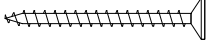
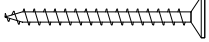
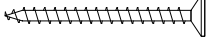
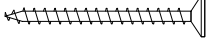
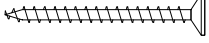
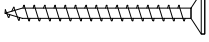
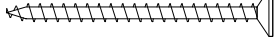
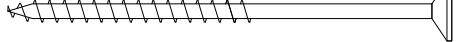
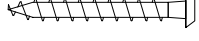
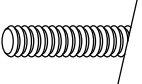
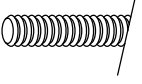
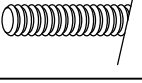

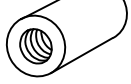

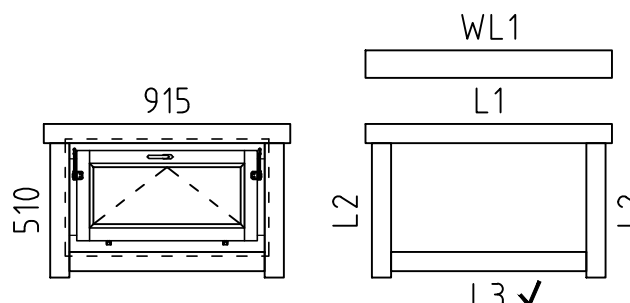
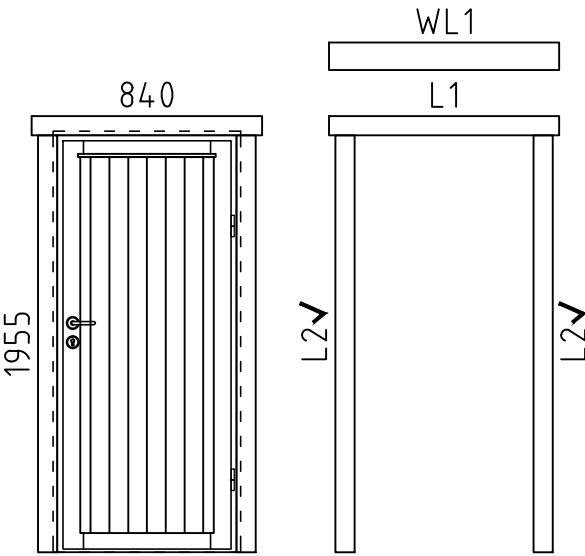

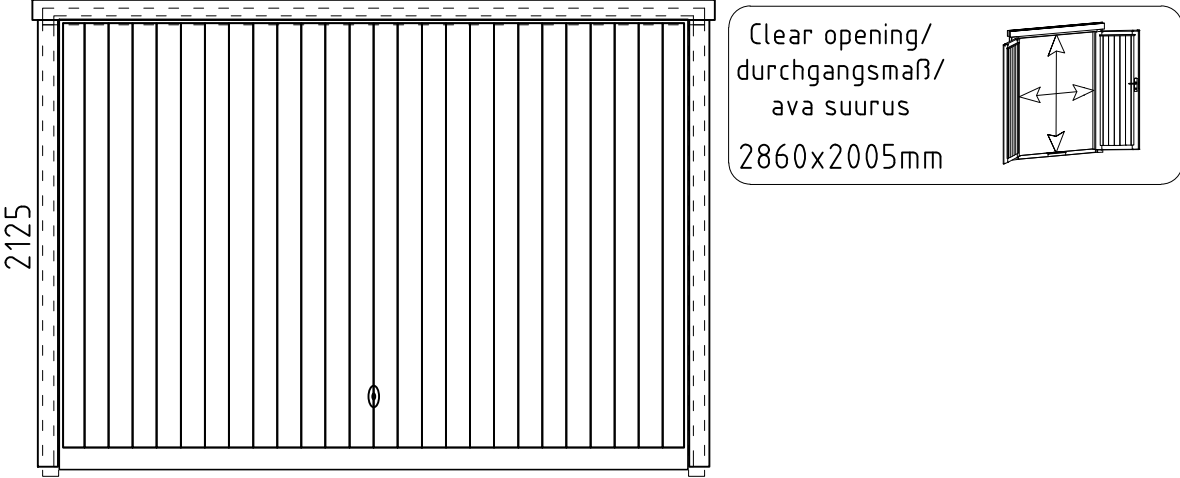
Name	Hansa Garage Deluxe B 470x575; 70		
Zeichnung/Drawing	Lagerholzplan, Foundation beams		
Profil/Profile	40	7.0x13.5	Datum/Date A3 30.03.2022

Pos	Teieliste/Specification Hansa Garage Deluxe B 470x575; 70	Stck. Pcs.	Profil Profile (mm)	Länge Length (mm)
000	 Extra log	1	70x135	5950
001		2	70x135	5950
002		1	70x135	5750
003		18	70x135	5750
004		2	70x135	4700
005		1	70x135	4700
006		1	70x135	4700
007		1	70x135	4700
008		1	70x135	4700
009		1	70x135	4700
010		17	70x135	4700
011		1	70x68	4700
012		1	70x135	4420
013		10	70x135	4420
014		1	70x135	3500
015		2	70x135	3500
016		6	70x135	865
017		2	70x68	825
018		16	70x135	825
019		8	70x135	825
020		6	70x135	825
021		12	70x135	470
022		4	70x135	470
023		14	70x135	470
024		2	70x68	470
025		19	70x135	370
Kood	Hansa Garage Deluxe B 470x575; 70	Materjal		Leht 1/4

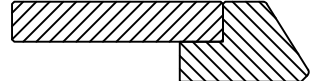
Pos	Teileliste/Specification Hansa Garage Deluxe B 470x575; 70		Stck. Pcs.	Profil Profile (mm)	Länge Length (mm)
026		175 100	4	70x135	345
027			8	70x135	300
FH1	FUNDAMENTHOLZ (imprägniert) - FOUNDATION BEAM (impregnated) 		2	70x45	5390
FH2	FUNDAMENTHOLZ (imprägniert) - FOUNDATION BEAM (impregnated) 		2	70x45	4480
FH3	FUNDAMENTHOLZ (imprägniert) - FOUNDATION BEAM (impregnated) 		2	70x45	290
TB1	TRÄGEBALKE - SUPPORT BEAM 		1	44x94	4350
PF1	PFETTEN - PURLINS 		5	58x170	5950
	DACHBRETTER - ROOF BOARDS 		106+2	113x18	2580
	DECKENLEISTEN - CEILING STRIPS 			15x28	37.0 lfm/rm
G02-1	GIEBELBRETTER - GABLE BOARDS 18x120 		4	18x120	2660
G01-1	GIEBELBRETTER - GABLE BOARDS 18x95 		4	18x95	2660
G06-1	GIEBELDECKLEISTEN - GABLE COVER STRIPS 18x58 		4	18x58	2660
G08-1	GIEBELLEISTEN - GABLE STRIPS 18x58 		4	18x58	2660
T01-1	TRAUFENBRETTER - EAVES BOARDS 18x95 		2	18x95	5950
T06-1	TRAUFENLEISTEN - EAVES STRIPS 18x40 			18x40	12.0 lfm/rm
GS	GIEBELSEGMENT - GABLE DIAMOND 		2		
TL70-1	T-LEISTEN - T-STRIPS 70 		6	45x70	490
TL70-2	T-LEISTEN - T-STRIPS 70 		2	45x70	1975
SH	SCHLAGHÖLZER - MOUNTING PIECES 		3		
PS01	PFETTENSCHUH - JOIST HANGER 45X97 		2		
ML1	Metallstange - Metal bar 		2	D10	1240
ML2	Metallstange - Metal bar 		2	D10	1170
ML3	Metallstange - Metal bar 		2	D10	970
ML4	Metallstange - Metal bar 		4	D10	900
ML5	Metallstange - Metal bar 		2	D10	770
Kood	Hansa Garage Deluxe B 470x575; 70		Materjal		Leht 2/4

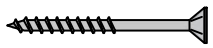
Pos	Teileliste/Specification Hansa Garage Deluxe B 470x575; 70		Stck Pcs.	Profil Profile (mm)	Länge Length (mm)
NG2 550	NÄGEL - NAILS 2.5x50	Dachbretter - Roof boards		848	
SR3 030	Schrauben - Screws 3.0x30	Deckenleisten - Ceiling strips		67	
SR3 030	Schrauben - Screws 3.0x30	Traufenleisten - Eaves strips		24	
SR37	Schrauben - Screws 3.5x45	Tür/Fensterleisten - Door/Window strips		82	
SR3 545	Schrauben - Screws 3.5x45	Giebelbretter - Gable boards		40	
SR3 545	Schrauben - Screws 3.5x45	Giebeldeckleisten - Gable cover strips		20	
SR3 545	Schrauben - Screws 3.5x45	Giebelleisten - Gable strips		20	
SR3 545	Schrauben - Screws 3.5x45	Giebelsegment - Gable diamond		4	
SR3 545	Schrauben - Screws 3.5x45	Traufenbretter - Eaves boards		24	
SR44	Schrauben - Screws 4.0x60	Wasserleiste - Rain strip		12	
SR5 0100	Schrauben - Screws 5.0x100	Fundamenthölzer - Foundation beams		24	
SR504 2-002	Schrauben - Screws 5.0x42	Pfettenschuhe - joist hanger		24	
KL1	Gewindestange - Threaded Rod M8			4	2000
KL2	Gewindestange - Threaded Rod M8			2	540
KL3	Gewindestange - Threaded Rod M8			4	460
KV M UT M8	Mutter - Nut M8			12	
KV S EIB M8X25	U-Scheibe - Washer M8 Ø25			12	
KV MU TJ M8	Befestigungsmutter - Fixing nut M8			4	
Kood	Hansa Garage Deluxe B 470x575; 70		Materjal		Leht 3/4

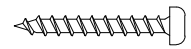
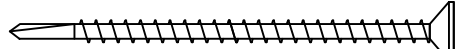
Pos	Teileliste/Specification Hansa Garage Deluxe B 470x575; 70	Stck. Pcs.	Profil Profile (mm)	Länge Length (mm)																
	<p>FENSTER/WINDOW 915x510 Q5 W5-S70K-0XT-09150510</p>  <p>RA68-15K/W106-KT</p> <table border="0"> <tr> <td>L1</td> <td>18x90</td> <td>L=1155mm</td> <td>2x</td> </tr> <tr> <td>L2</td> <td>18x90</td> <td>L=630mm</td> <td>4x</td> </tr> <tr> <td>L3</td> <td>18x90</td> <td>L=915mm</td> <td>2x ✓</td> </tr> <tr> <td>WL1</td> <td>36x129</td> <td>L=1155mm</td> <td>1x</td> </tr> </table>	L1	18x90	L=1155mm	2x	L2	18x90	L=630mm	4x	L3	18x90	L=915mm	2x ✓	WL1	36x129	L=1155mm	1x	3		
L1	18x90	L=1155mm	2x																	
L2	18x90	L=630mm	4x																	
L3	18x90	L=915mm	2x ✓																	
WL1	36x129	L=1155mm	1x																	
	<p>TÜR/DOOR 840x1955 Q5 D5-S70R-XXX-08401955</p>  <p>U5-SH (196)/D103-RX</p> <table border="0"> <tr> <td>L1</td> <td>18x90</td> <td>L=1080mm</td> <td>2x</td> </tr> <tr> <td>L2</td> <td>18x90</td> <td>L=1955mm</td> <td>4x ✓</td> </tr> <tr> <td>WL1</td> <td>36x129</td> <td>L=1080mm</td> <td>1x</td> </tr> </table> <p>DIN rechts; right handed</p>	L1	18x90	L=1080mm	2x	L2	18x90	L=1955mm	4x ✓	WL1	36x129	L=1080mm	1x	1						
L1	18x90	L=1080mm	2x																	
L2	18x90	L=1955mm	4x ✓																	
WL1	36x129	L=1080mm	1x																	
	<p>Achtung! Die Giebelbohlen können teilweise schon vormontiert sein! Bitte beachten - diese erscheinen nicht ganz so wie in der Teileliste beschrieben.</p>																			
	<p>Notice! The gable pieces can be partly pre-assembled! Please notice - those differ from the description given in the specification list.</p>																			
	<p>✓ - Bitte selber anpassen (falls nötig)! / Cut into length on site (if needed)!</p>																			
Kood	Hansa Garage Deluxe B 470x575; 70	Materjal	Leht	4/4																

Pos	Teieliste/Specification Hansa Garage Deluxe B 470x575; 70	Stck. Pcs.	Profil Profile (mm)	Länge Length (mm)	
	<p>TÜR/DOOR 3000x2125 D0-H70H-XXX-30002125 (45) GV-HR2 3000</p> 	1			
DB-HR-1	Door boards - Türbretter - Ukse lauad 18x113 GV-HR		27	18x113	2010
LL4-1	Frame extensions - Verbreiterungsleiste - Laiendusliistud 20x72		2	20x72	2095
LL4-2	Frame extensions - Verbreiterungsleiste - Laiendusliistud 20x72		1	20x72	3000
WL-1	Rain strips - Wasserleisten - Vihmaliistud 36x134		1	36x134	3200
PL3-1	Trims - Rahmenleisten - Piirdeliistud 18x95	 ✓	2	18x95	2095
PL3-2	Trims - Rahmenleisten - Piirdeliistud 18x95	 ✓	1	18x95	3200
SR35 47-01	3.5x45 C3 Trims - Rahmleisten - Piirdeliistud		14		
SR40 16-01	4.0x16 Door boards - Türbretter - Ukse lauad 18x113 GV-HR		220		
SR40 62-01	4.0x60 C3 Rain strip - Wasserleiste - Vihmaliist		8		
SR45 37-01	4.5x35ÜP Frame - Rahmen - Raam		12		
SR551 00-01	5.5x100 (Flügel) Frame extensions - Verbreiterungsleiste - Laiendusliistud GV-HR		8		
W10-01	Slide angle bracket - Setzungswinkel - Vajumisnurgik 30x40x100		6		
US0 1-01	Washer - U-Scheibe - Seib M5 Ø20		6		
Kood	Hansa Garage Deluxe B 470x575; 70	Materjal		Leht	5/6

Montageanleitung für T-Leisten / Installing the door and window supports / Tenderliistu paigaldusjuhend.

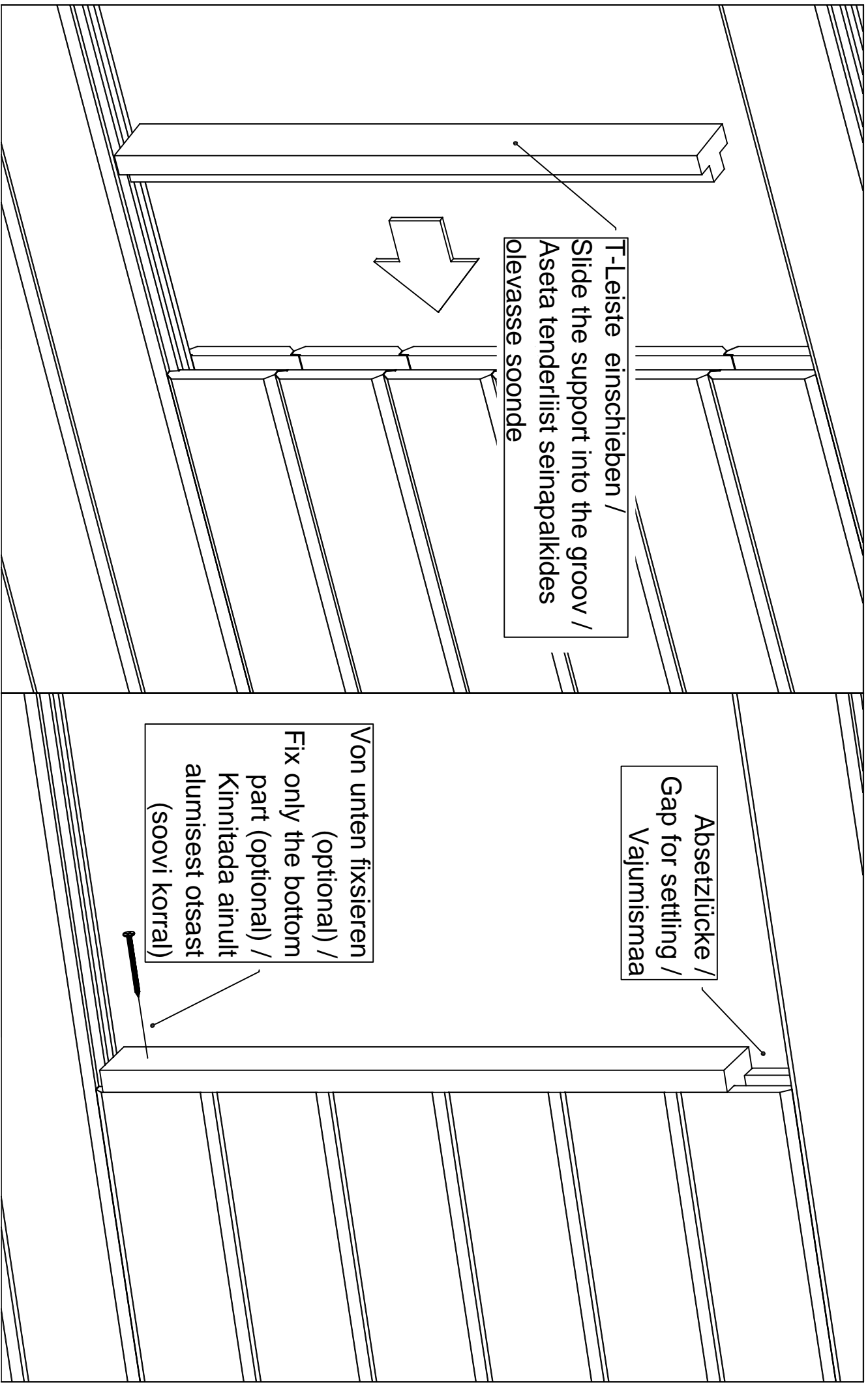

Aken	Q4-Q6	-	paigaldusjuhis
Window	Q4-Q6	-	assembly instructions
Fenster	Q4-Q6	-	Montageanleitung

5-10mm

3.5x45

Lõika mõõtu
Cut to length
Absägen
- 10mm / -20mm

NB!

3.5x45

Vihmaliist / Rain strip / Wasserleiste

Q5-Q6

*Silikoon
*Silicon
*Silikon

*Vajumispilu
*Settling gap
*Senkungs spalt

ca 40-50mm

NB!

- Monteerida juhul kui ese on välja toodud maja spetsifikatsioonis!
- Install only if the item is listed in the house specification!
- Nur montieren wenn die Leiste in der Teileliste gezeigt ist!

Veeplekk / Window sill / Fensterbank

4,2x16

GV-HR

1. Fundamenthölzer absagen - Cut the Foundation beams

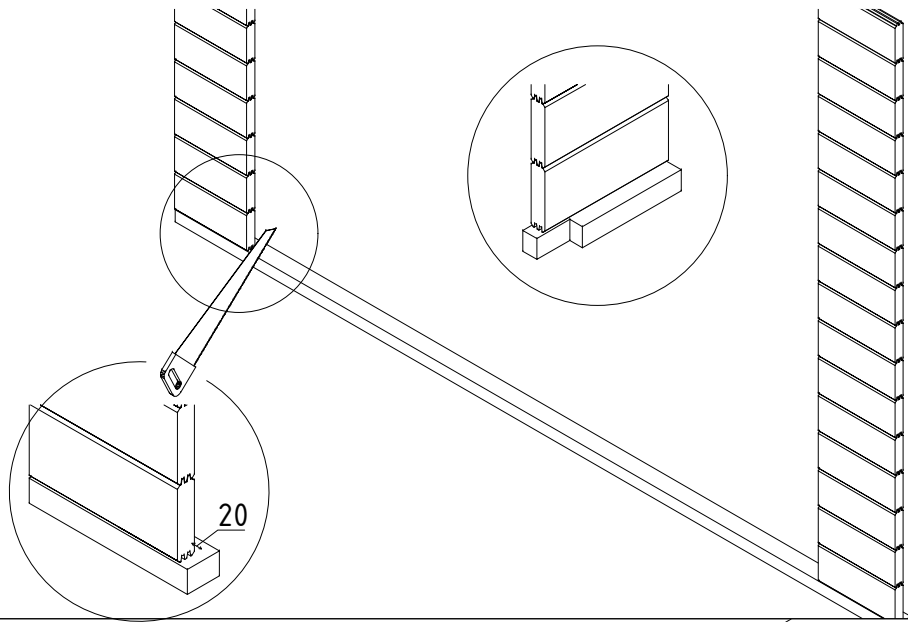

Schraube - Screw 5.0x42

Pfettenschuhe - Joist hanger

Trägebalken - support beam

2. Montieren Trägebalken - Install the Support beam

3. Verbinden das Schwingtor - Connect the Up and Over Garage Door

(Siehe die Hörmann Anleitung für Montage - Follow the Hörmann Installation Instructions)

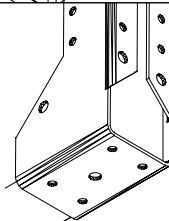

NB! Vorbohren Sie ein Loch - Pre-drill a hole

Schraube - Screw 5.5x100 (Flügel)

4. Verbinden die Leisten L2 - Connect the Strips L2

GV-HR

5. Befestigen der Setzungswinkel - Fasten the slide angle bracket

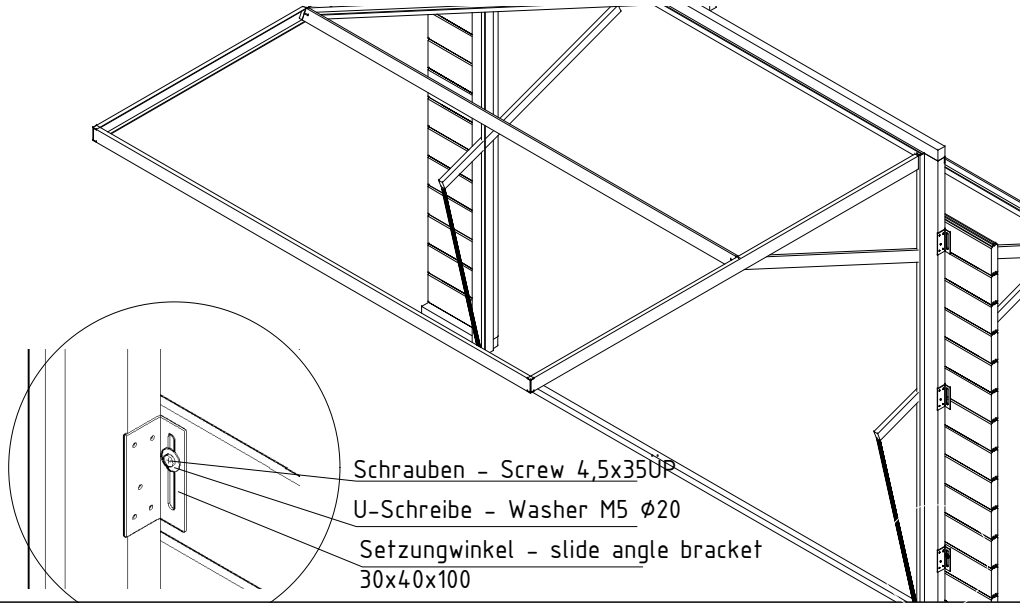

6. Befestigen die Leiste L1 - Fasten the strip L1
(Vorbohren Sie ein Loch - Pre-drill a hole)

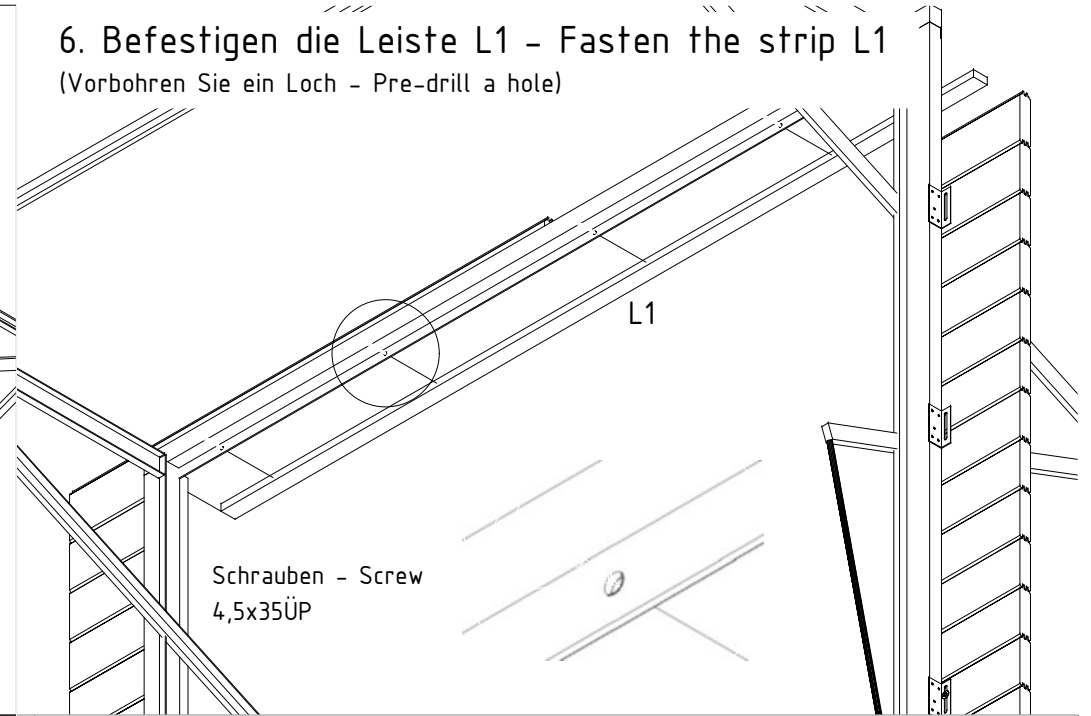

7. Befestigen die Leisten - Fasten the Strips

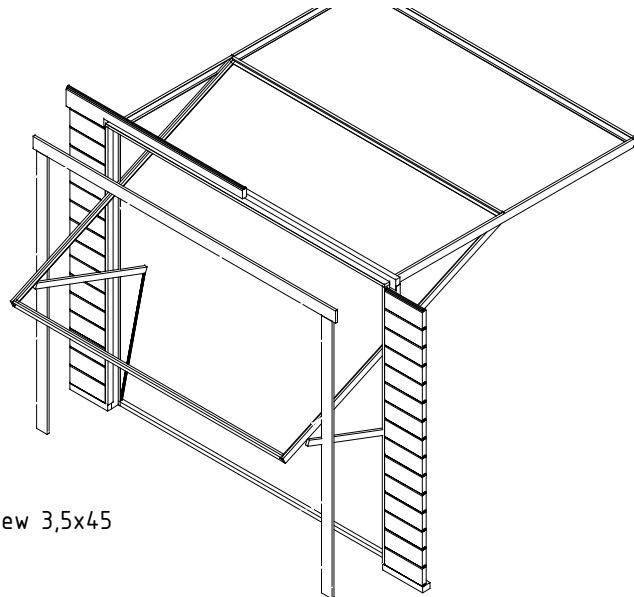

8. Befestigen die Türbretter - Fasten the door board
(mit Schrauben 4.0x16, with Screw 4.0x16)

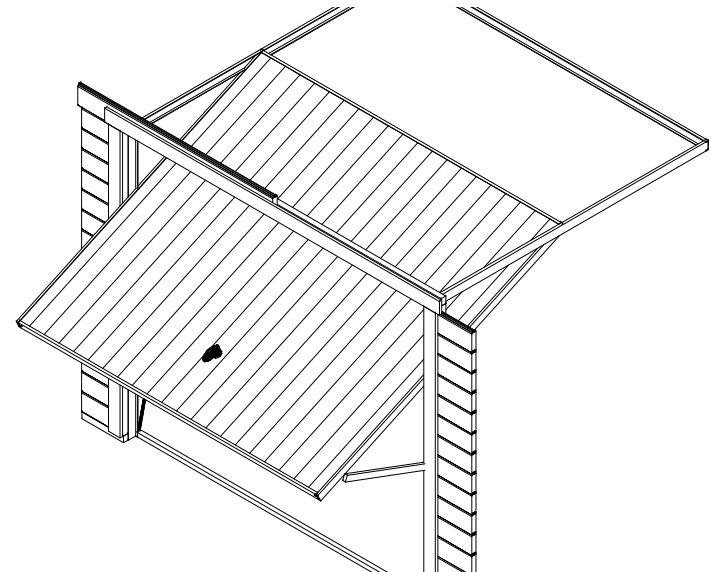

Aussen - Outside

Innen - Inside

- Giebeldeckleisten
- Gable cover boards
- Dachbretter
- Roof boards
- Giebelbretter
- Gable boards
- Pfetten/Wandbohlen
- Purlins/Wall log

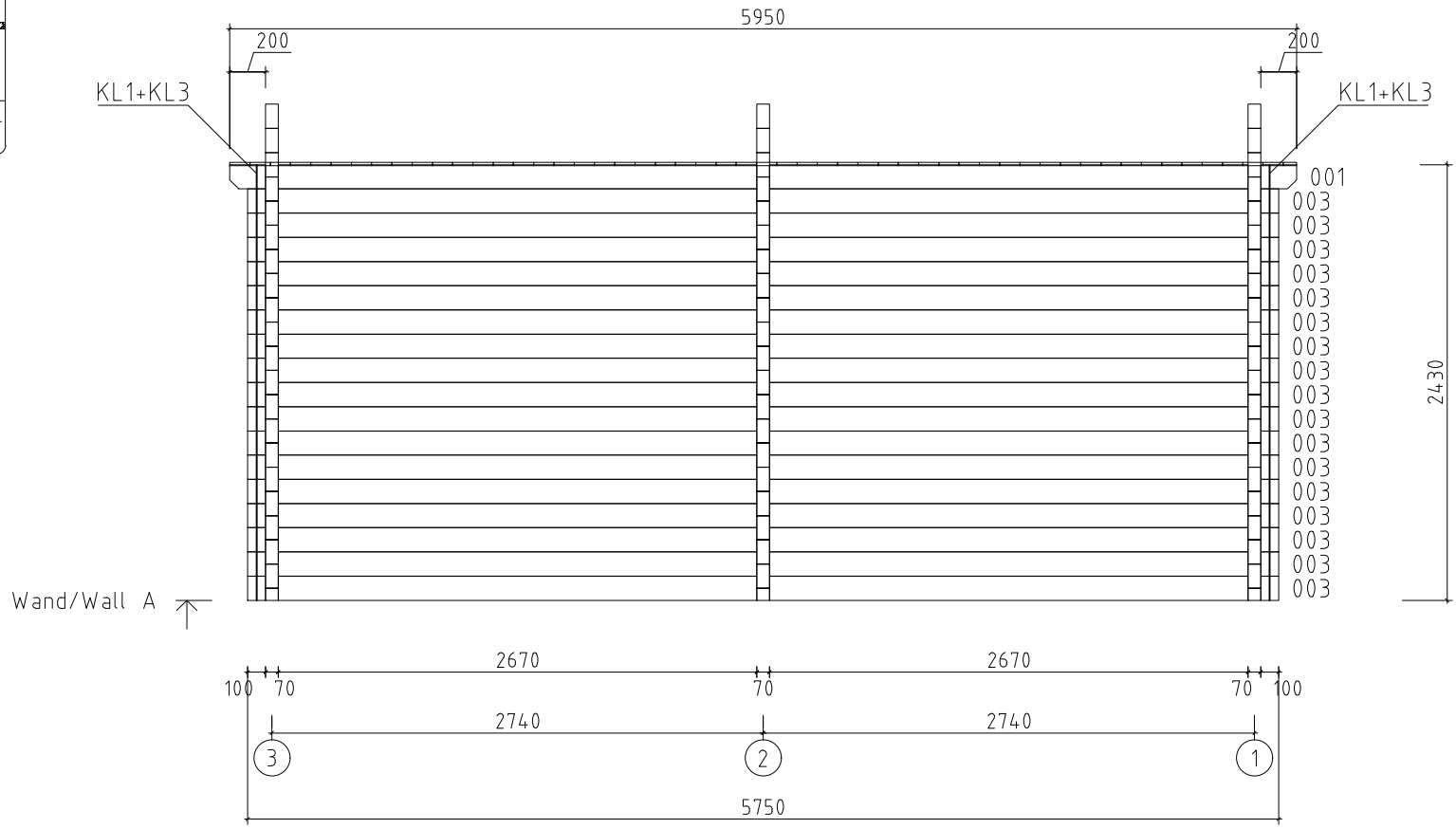

Wand/Wall A ↗

Name				Hansa Garage Deluxe B 470x575; 70	
Zeichnung/Drawing				WAND/WALL A	
Maßstab/Scale	1:40	Profil/Profile	7.0x13.5	Druck auf	A4
				Datum/Date	30.03.2022

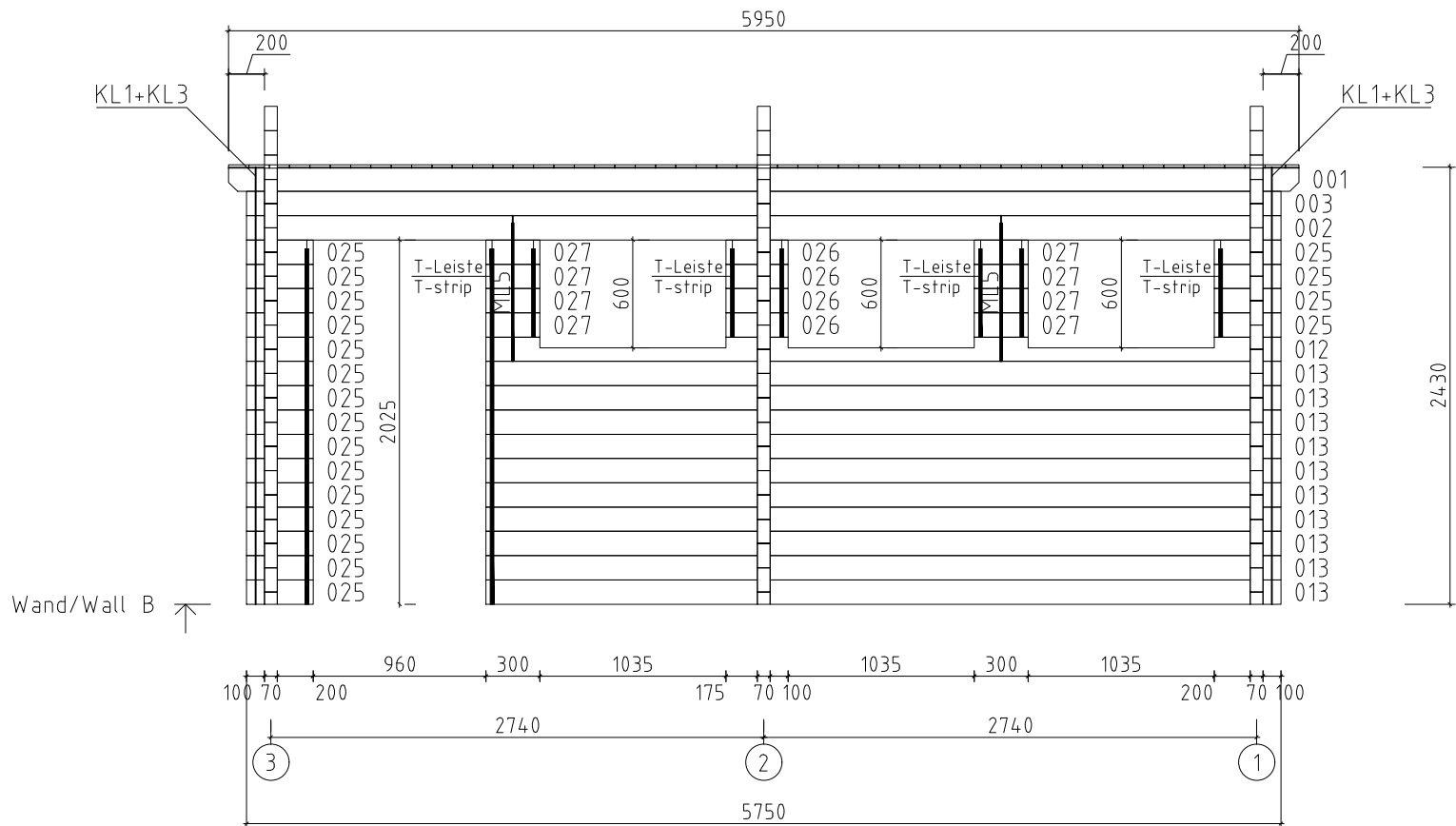

Name				Hansa Garage Deluxe B 470x575; 70			
Zeichnung/Drawing				WAND/WALL B			
Maßstab/Scale	1:40	Profil/Profile	7.0x13.5	Druck auf	A4	Datum/Date	30.03.2022

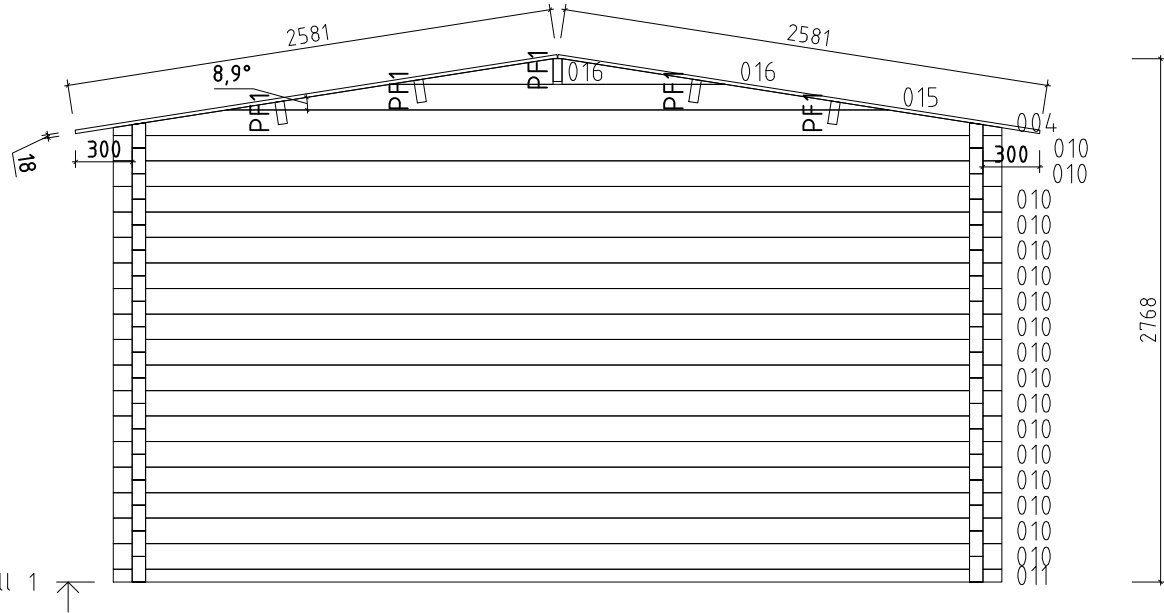
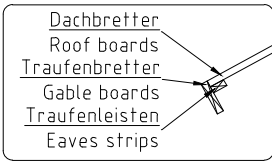

Wand/Wall 1 ↑

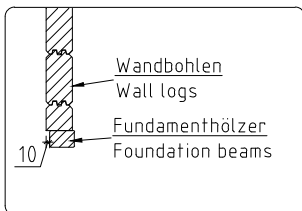
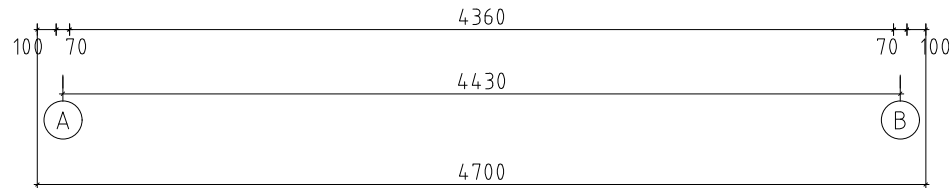

Name				Hansa Garage Deluxe B 470x575; 70			
Zeichnung/Drawing				WAND/WALL 1			
Maßstab/Scale	1:40	Profil/Profile	7.0x13.5	Druck auf	A4	Datum/Date	30.03.2022

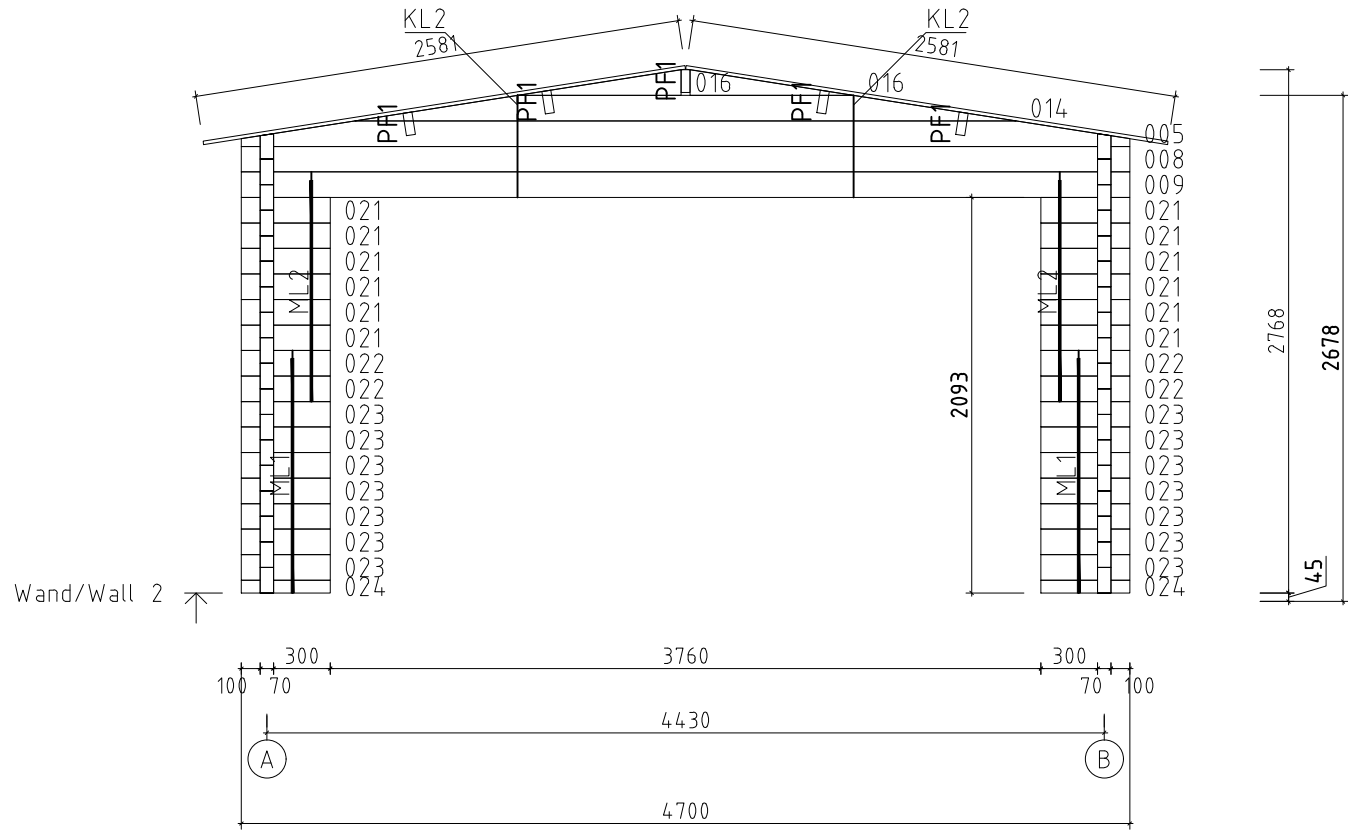

Name				Hansa Garage Deluxe B 470x575; 70			
Zeichnung/Drawing				WAND/WALL 2			
Maßstab/Scale	1:40	Profil/Profile	7.0x13.5	Druck auf	A4	Datum/Date	30.03.2022

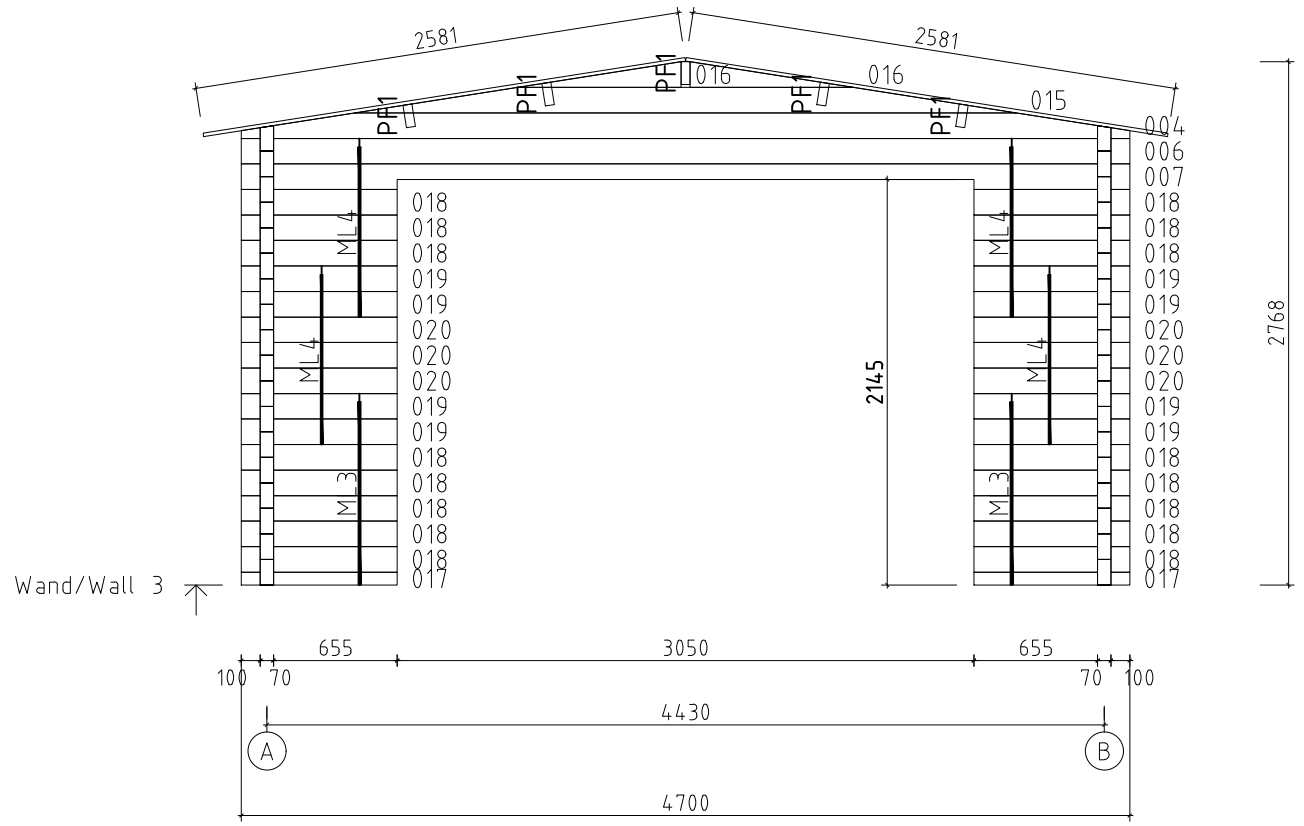

Name				Hansa Garage Deluxe B 470x575; 70			
Zeichnung/Drawing				WAND/WALL 3			
Maßstab/Scale	1:40	Profil/Profile	7.0x13.5	Druck auf	A4	Datum/Date	30.03.2022