

Name	Hansa Holiday F 720x820+VD 70		
Zeichnung/Drawing	3D		
Profil/Profile	7x13.5	Datum/Date	24.08.2021

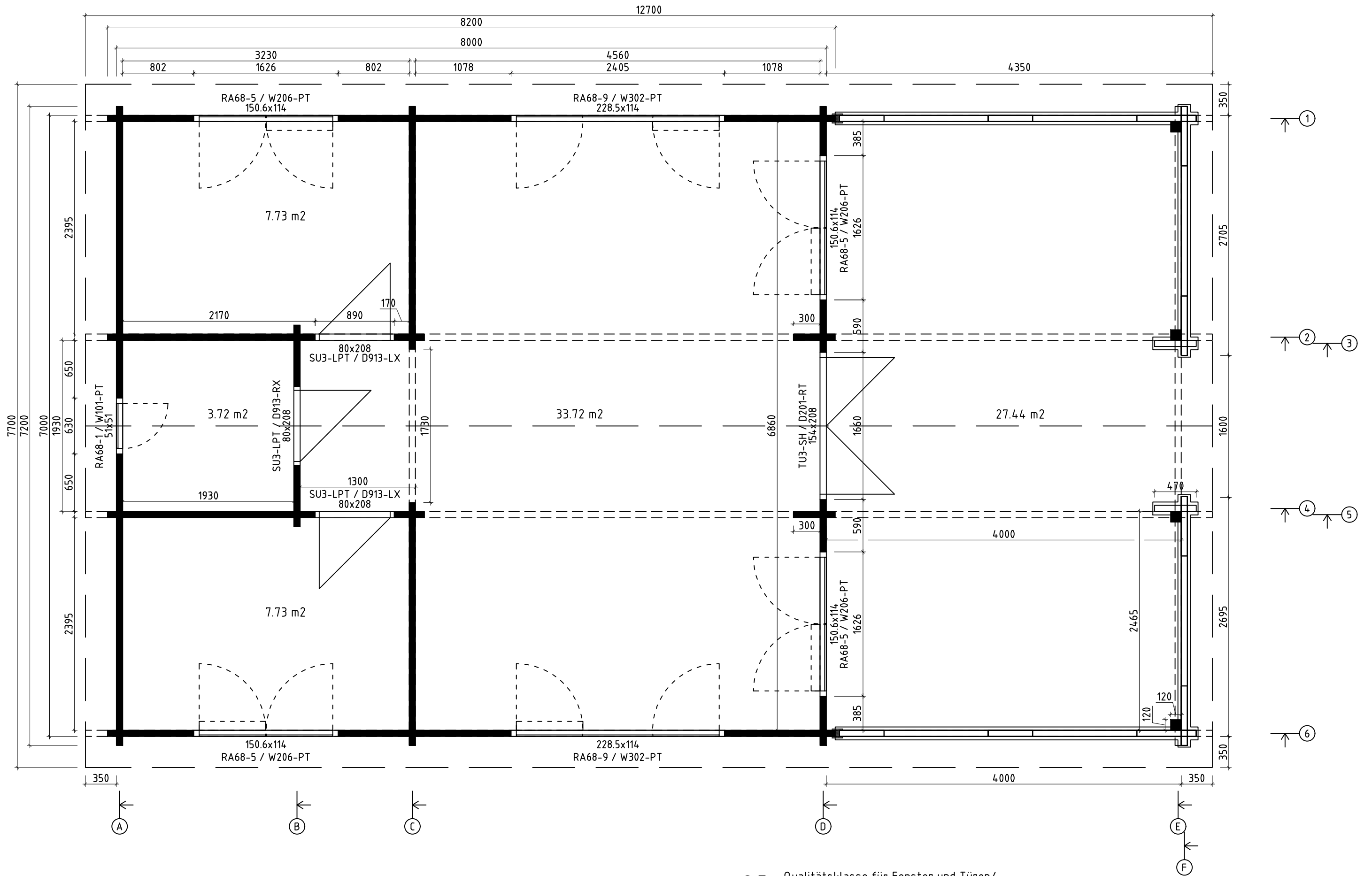

Q5 – Qualitätsklasse für Fenster und Türen/
Quality class for windows and doors







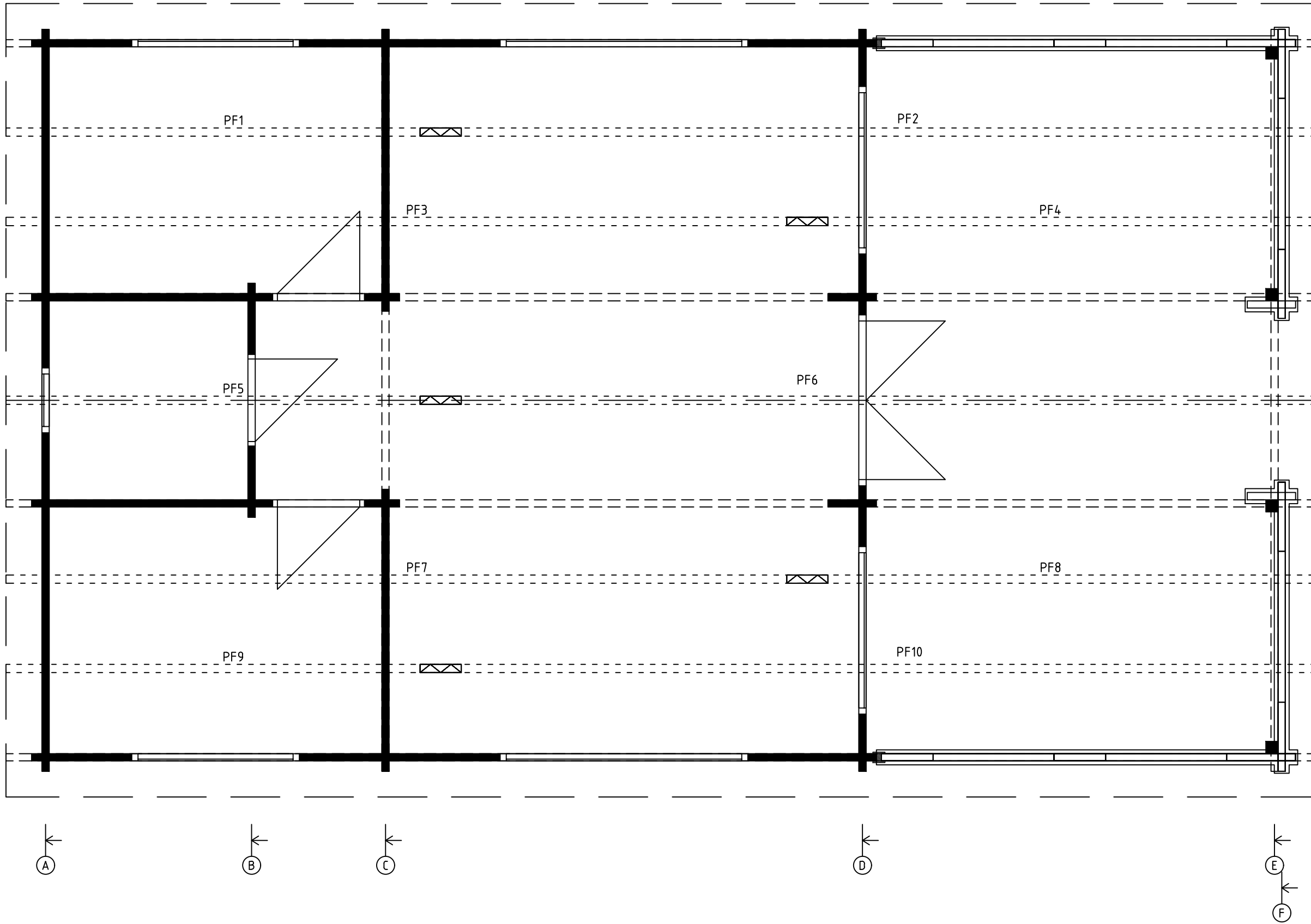



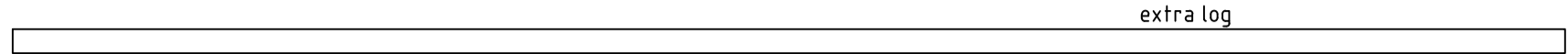
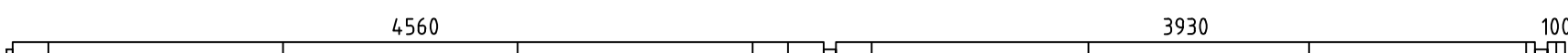
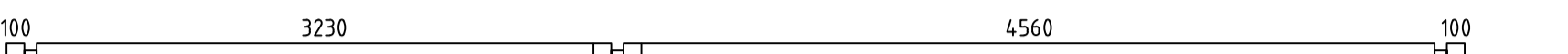

* Fenster und Türen sind mit Sprossen/
Windows and doors are with muntins

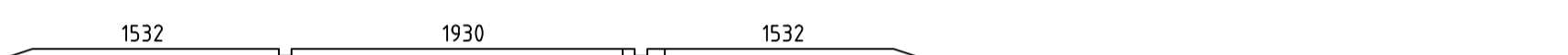
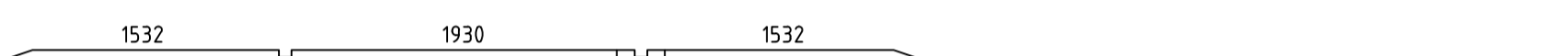
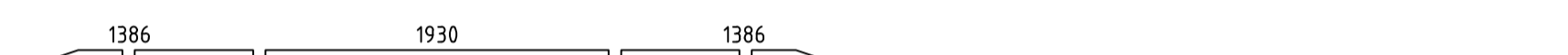

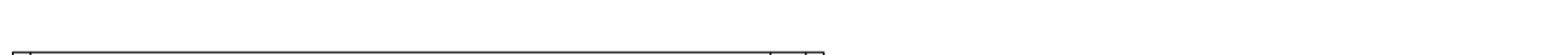
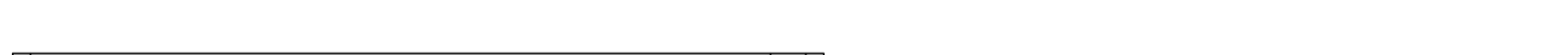

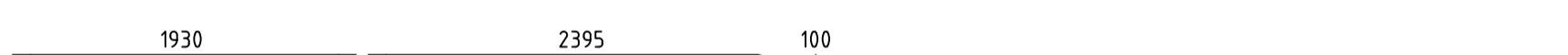

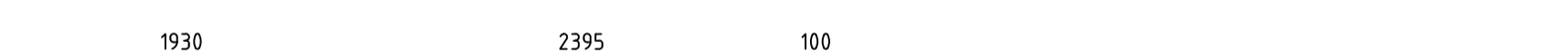
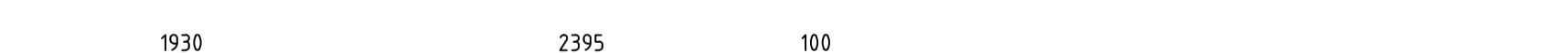
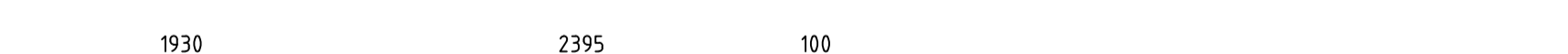
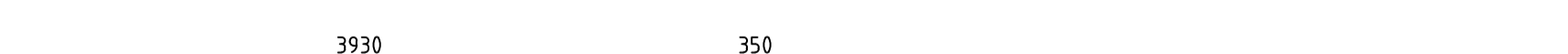
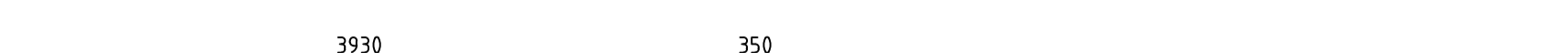
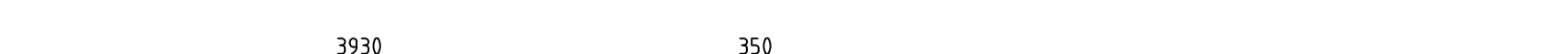
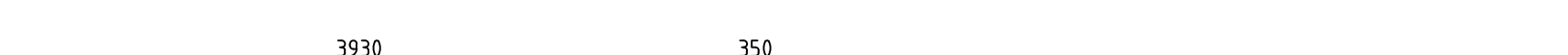



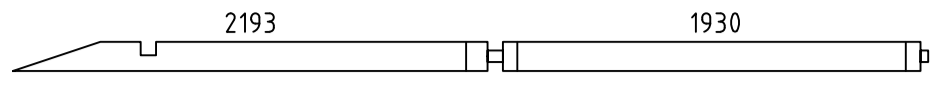
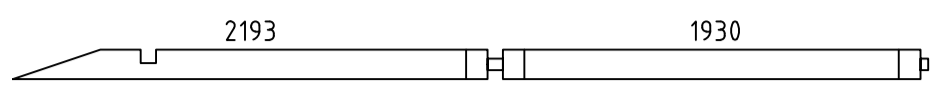
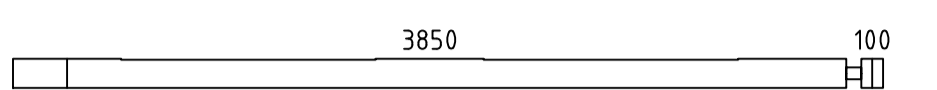
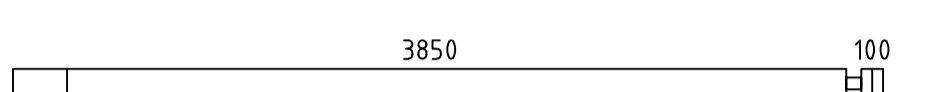
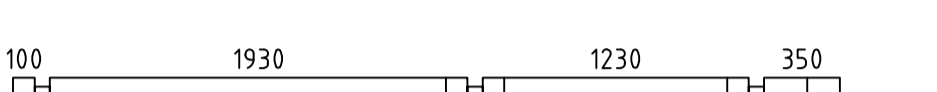
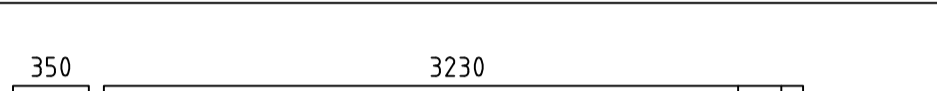
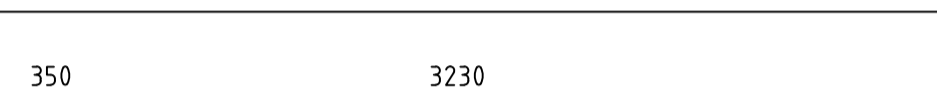
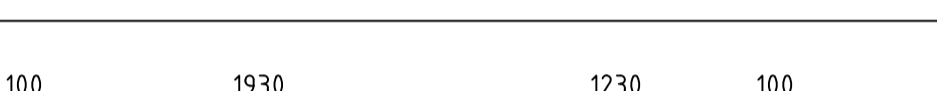
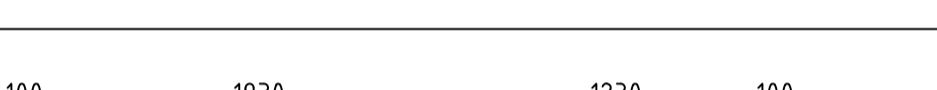
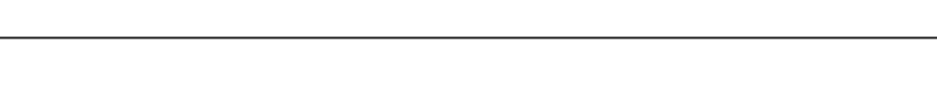
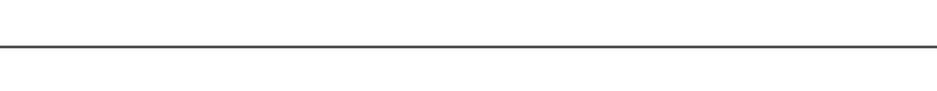
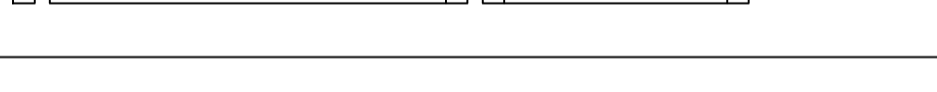
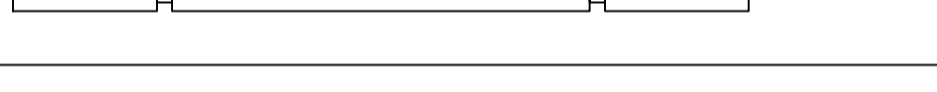
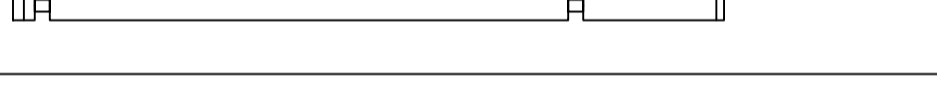
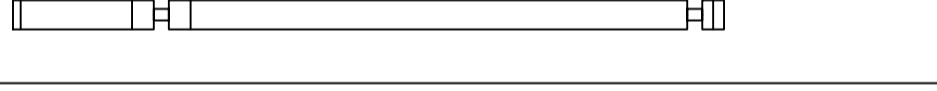

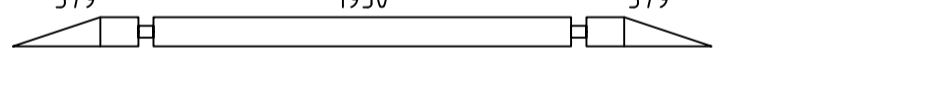
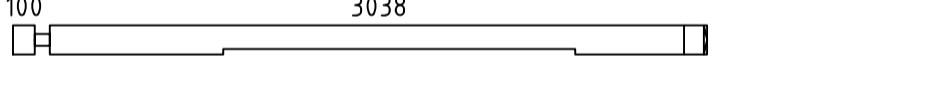
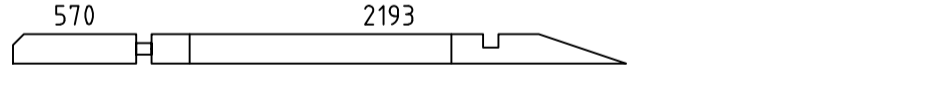
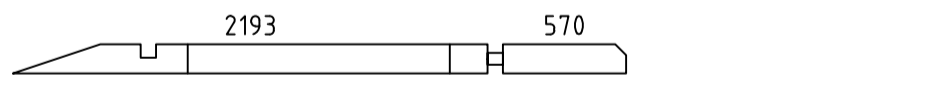
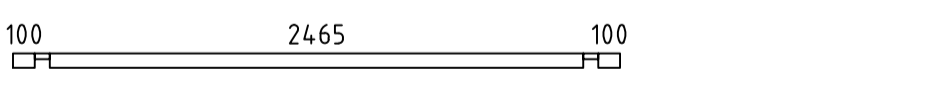
Name	Hansa Holiday F 720x820+VD 70		
Zeichnung/Drawing	Grundplan_Plan	Druck auf/print on	A3
Maßstab/Scale	1:40	Profil/Profile	7x13.5
		Datum/Date	24.08.2021

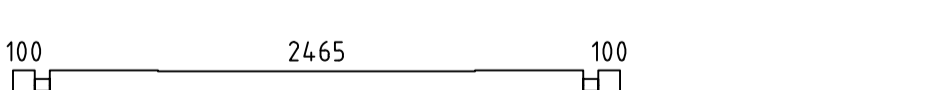
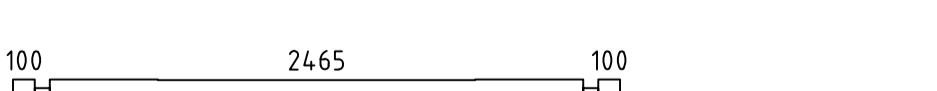



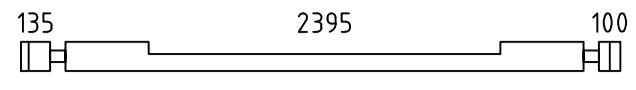
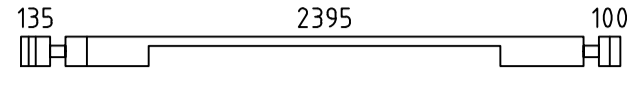
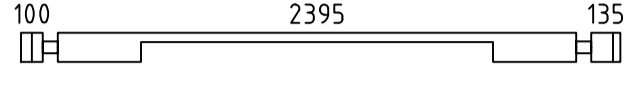
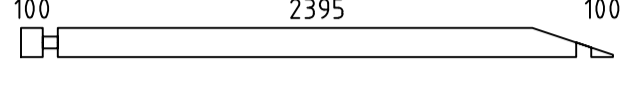
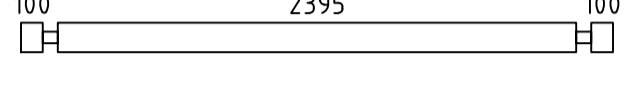
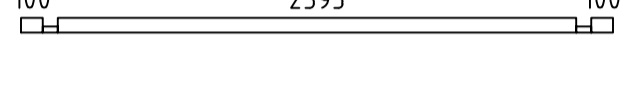
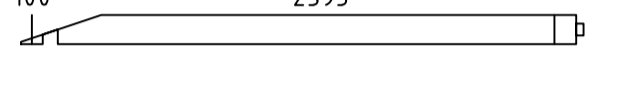
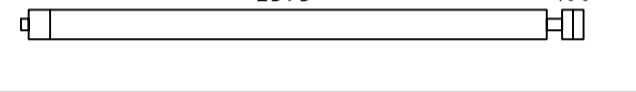
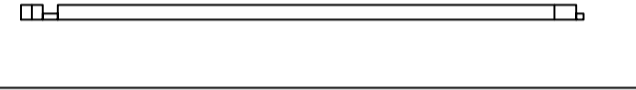
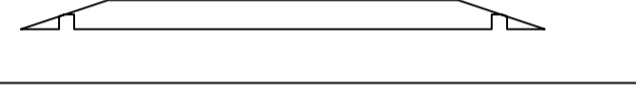
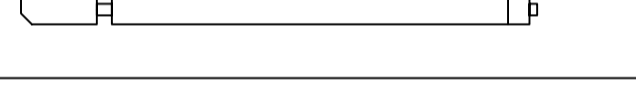
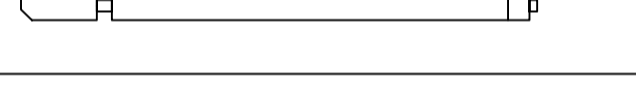
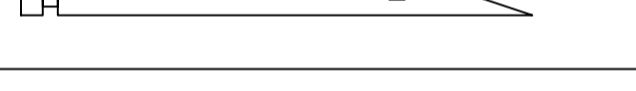
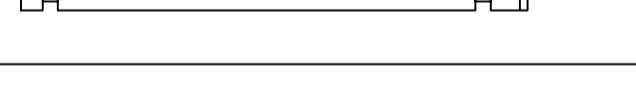
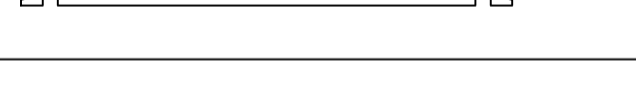

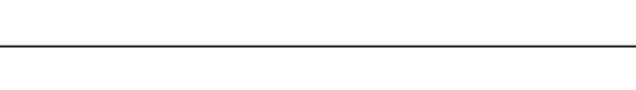
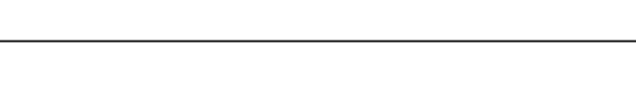

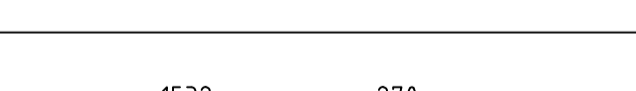
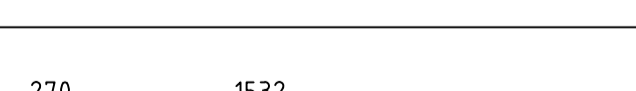
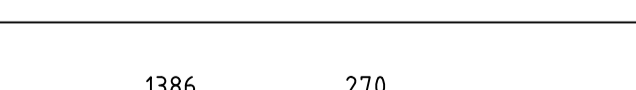
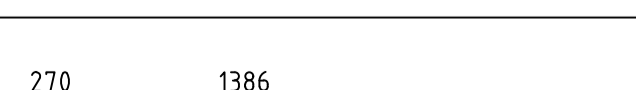
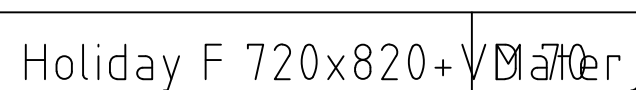

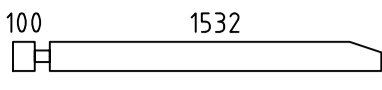
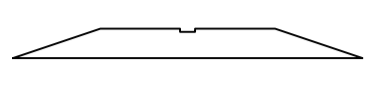
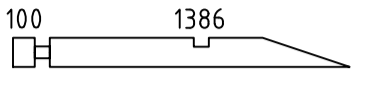
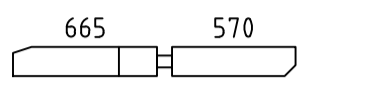
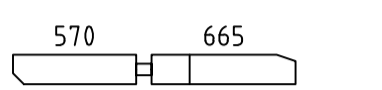
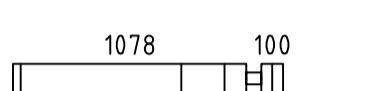
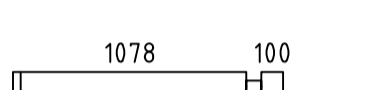
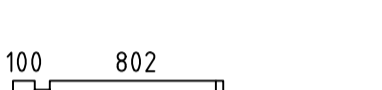
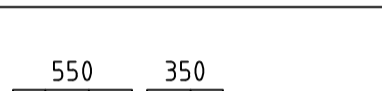

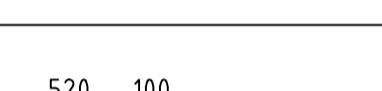
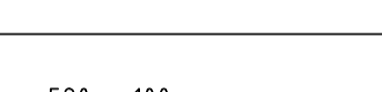
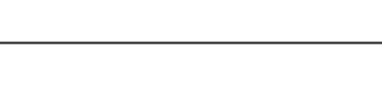
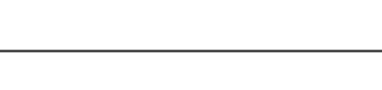
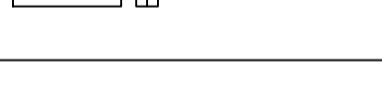



























Name	Hansa Holiday F 720x820+VD 70		
Zeichnung/Drawing	Pfetten_Purlins	Druck auf/print on	A3
Maßstab/Scale	1:40	Profil/Profile	7x13.5
		Datum/Date	24.08.2021









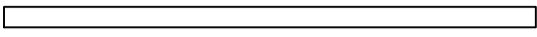
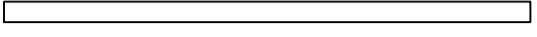

Pos	Teilleiste/Specification Hansa Holiday F 720x820+VD 70	Stck Pcs.	Profil Profile (mm)	Länge Length (mm)
	<u>Achtung!</u> Die Giebelbohlen können teilweise schon vormontiert sein! Bitte beachten - diese erscheinen nicht ganz so wie in der Teilleiste beschrieben.			
	<u>Notice!</u> The gable pieces can be partly pre-assembled! Please notice - those differ from the description given in the specification list.			
000	 extra log	1	70x135	8765
001		2	70x135	8765
002		4	70x135	8200
003		1	70x135	7200
004		1	70x135	7200
005		1	70x135	5930
006		1	70x135	5930
007		1	70x135	5135
008		1	70x135	5135
009		2	70x135	4842
010		8	70x135	4765
011		2	70x135	4645
012		1	70x135	4630
013		1	70x135	4630
014		1	70x135	4600
015		1	70x135	4600
016		1	70x135	4600
017		1	70x135	4600
018		10	70x135	4600
019		1	70x68	4600
020		1	70x135	4600
021		1	70x135	4385
022		1	70x135	4385
023		1	70x135	4385
024		1	70x135	4385
025		2	70x135	4377
Kood	Hansa Holiday F 720x820+VD 70	Material	File	Hansa Holiday F 720x820+VD 70.dwg 1/10

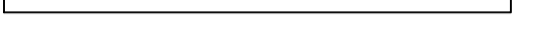
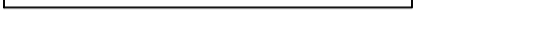
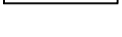
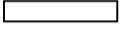
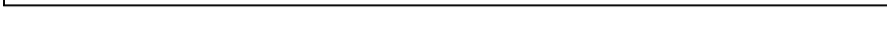
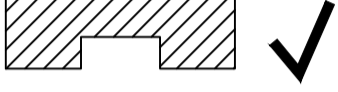

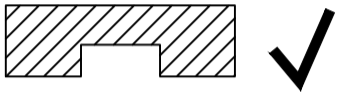

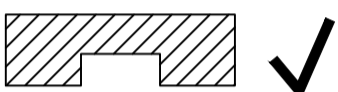
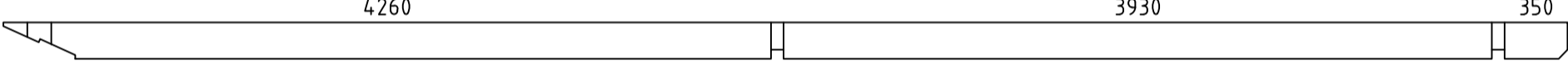
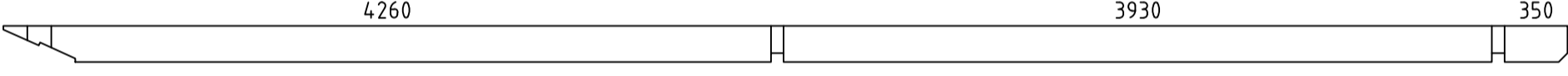
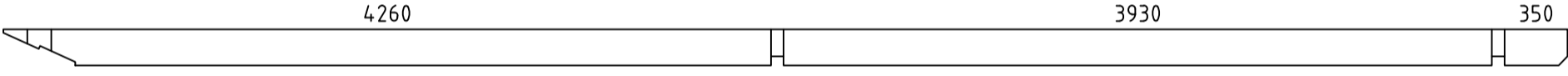
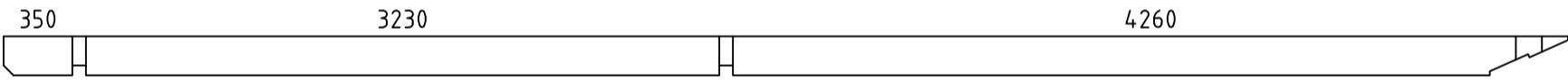
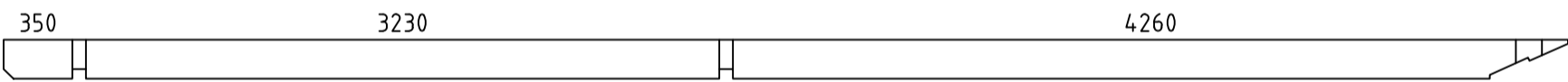
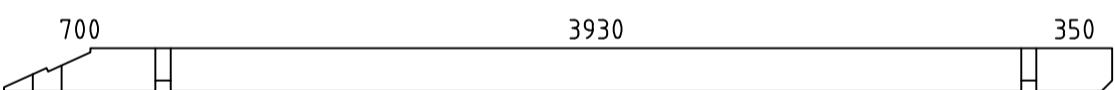
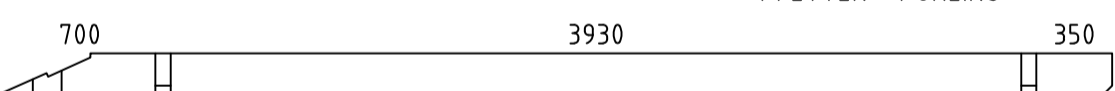
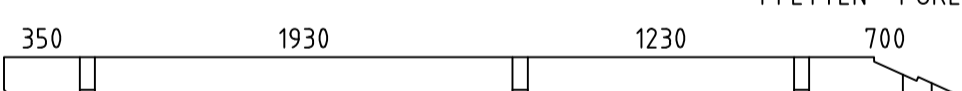
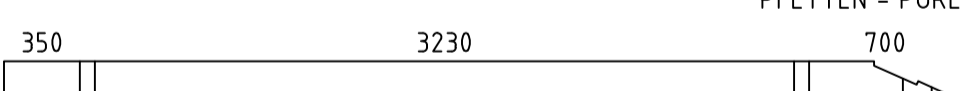
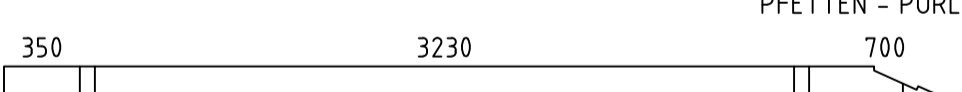
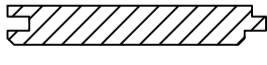



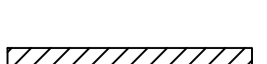



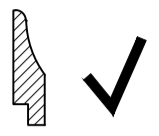
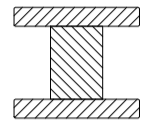
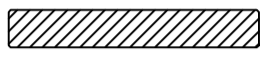

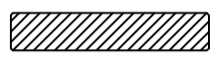

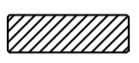

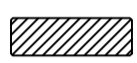

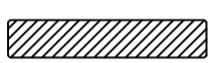
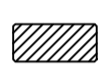

Pos	Teileliste/Specification Hansa Holiday F 720x820+VD 70	Stck Pcs.	Profil Profile (mm)	Länge Length (mm)
026		1	70x135	4228
027		1	70x135	4228
028		6	70x135	4020
029		2	70x135	4020
030		2	70x135	3820
031		1	70x135	3685
032		1	70x135	3685
033		2	70x135	3570
034		8	70x135	3570
035		8	70x135	3435
036		2	70x135	3435
037		2	70x135	3400
038		6	70x135	3285
039		2	70x135	3285
040		3	70x135	3228
041		1	70x135	3228
042		2	70x135	3208
043		1	70x135	2833
044		1	70x135	2833
045		2	70x68	2805
046		2	70x135	2805
047		4	70x135	2805
048		2	70x68	2805
049		2	70x68	2770
050		10	70x135	2770



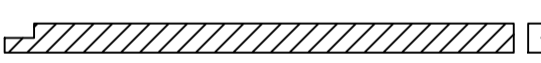

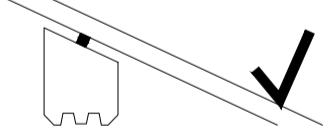

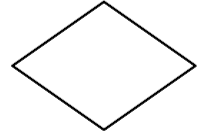
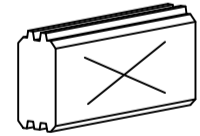
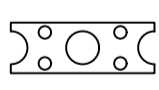
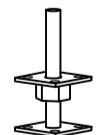
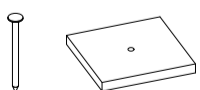

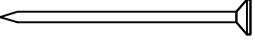



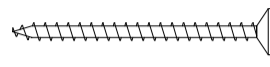
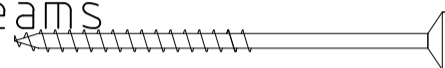
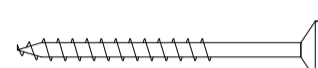



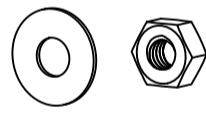
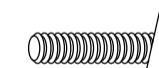

Pos	Teileliste/Specification Hansa Holiday F 720x820+VD 70	Stck Pcs.	Profil Profile (mm)	Länge Length (mm)
051		2	70x135	2770
052		1	70x135	2770
053		1	70x135	2770
054		2	70x135	2735
055		32	70x135	2735
056		2	70x68	2735
057		2	70x135	2600
058		13	70x135	2600
059		1	70x68	2600
060		4	70x135	2421
061		1	70x135	2385
062		1	70x135	2385
063		2	70x135	2363
064		30	70x135	2340
065		1	70x135	2270
066		6	70x135	2270
067		1	70x135	2270
068		2	70x135	2228
069		14	70x135	1950
070		2	70x135	1950
071		2	70x135	1950
072		1	70x135	1872
073		1	70x135	1872
074		1	70x135	1726
075		1	70x135	1726

Pos	Teileliste/Specification Hansa Holiday F 720x820+VD 70	Stck Pcs.	Profil Profile (mm)	Länge Length (mm)
076		2	70x135	1702
077		5	70x135	1614
078		2	70x135	1556
079		1	70x135	1305
080		1	70x135	1305
081		2	70x135	1248
082		16	70x135	1248
083		18	70x135	972
084		2	70x135	970
085		2	70x135	835
086		2	70x68	690
087		30	70x135	690
088		12	70x135	670
089		6	70x135	670
090		16	70x135	590
091		16	70x135	555
092		2	70x135	520
093		6	70x135	500
094		6	70x135	500
095		22	70x135	470
096		8	70x135	470
097		10	70x135	470
098		2	70x135	470
099		12	70x135	470
100		10	70x123	369

Pos	Teileliste/Specification Hansa Holiday F 720x820+VD 70		Stck Pcs.	Profil Profile (mm)	Länge Length (mm)
101			30	70x135	340
102			8	70x135	270
103			8	70x83	248
104			8	70x63	187
FH25	FUNDAMENTHOLZ (imprägniert) - FOUNDATION BEAM (impregnated) 		1	70x95	4508
FH8	FUNDAMENTHOLZ (imprägniert) - FOUNDATION BEAM (impregnated) 		1	70x95	4433
FH26	FUNDAMENTHOLZ (imprägniert) - FOUNDATION BEAM (impregnated) 		1	70x95	3915
FH20	FUNDAMENTHOLZ (imprägniert) - FOUNDATION BEAM (impregnated) 		2	70x95	3222
FH7	FUNDAMENTHOLZ (imprägniert) - FOUNDATION BEAM (impregnated) 		1	70x95	2458
FH5	FUNDAMENTHOLZ (imprägniert) - FOUNDATION BEAM (impregnated) 		1	70x95	1885
FH22	FUNDAMENTHOLZ (imprägniert) - FOUNDATION BEAM (impregnated) 		1	70x95	525
FH19	FUNDAMENTHOLZ (imprägniert) - FOUNDATION BEAM (impregnated) 		7	70x95	521
FH14	FUNDAMENTHOLZ (imprägniert) - FOUNDATION BEAM (impregnated) 		1	45x95	4668
FH28	FUNDAMENTHOLZ (imprägniert) - FOUNDATION BEAM (impregnated) 		1	45x95	4655
FH17	FUNDAMENTHOLZ (imprägniert) - FOUNDATION BEAM (impregnated) 		2	45x95	4508
FH11	FUNDAMENTHOLZ (imprägniert) - FOUNDATION BEAM (impregnated) 		3	45x95	4458
FH2	FUNDAMENTHOLZ (imprägniert) - FOUNDATION BEAM (impregnated) 		3	45x95	4433
FH10	FUNDAMENTHOLZ (imprägniert) - FOUNDATION BEAM (impregnated) 		13	45x95	4388
FH15	FUNDAMENTHOLZ (imprägniert) - FOUNDATION BEAM (impregnated) 		2	45x95	4050
FH18	FUNDAMENTHOLZ (imprägniert) - FOUNDATION BEAM (impregnated) 		2	45x95	3915
FH27	FUNDAMENTHOLZ (imprägniert) - FOUNDATION BEAM (impregnated) 		1	45x95	3325
FH13	FUNDAMENTHOLZ (imprägniert) - FOUNDATION BEAM (impregnated) 		1	45x95	3313
FH23	FUNDAMENTHOLZ (imprägniert) - FOUNDATION BEAM (impregnated) 		2	45x95	3222
FH16	FUNDAMENTHOLZ (imprägniert) - FOUNDATION BEAM (impregnated) 		8	45x95	3177
FH6	FUNDAMENTHOLZ (imprägniert) - FOUNDATION BEAM (impregnated) 		2	45x95	2601

Pos	Teileliste/Specification Hansa Holiday F 720x820+VD 70		Stck Pcs.	Profil Profile (mm)	Länge Length (mm)
FH1	FUNDAMENTHOLZ (imprägniert) - FOUNDATION BEAM (impregnated) 		3	45x95	2458
FH12	FUNDAMENTHOLZ (imprägniert) - FOUNDATION BEAM (impregnated) 		3	45x95	2433
FH3	FUNDAMENTHOLZ (imprägniert) - FOUNDATION BEAM (impregnated) 		2	45x95	2388
FH9	FUNDAMENTHOLZ (imprägniert) - FOUNDATION BEAM (impregnated) 		13	45x95	2343
FH4	FUNDAMENTHOLZ (imprägniert) - FOUNDATION BEAM (impregnated) 		5	45x95	1885
FH21	FUNDAMENTHOLZ (imprägniert) - FOUNDATION BEAM (impregnated) 		1	45x95	525
FH24	FUNDAMENTHOLZ (imprägniert) - FOUNDATION BEAM (impregnated) 		1	45x95	524
HL2	HANDLAUF - HANDRAIL  	2	145x44	4090	
HL1	HANDLAUF - HANDRAIL  	2	145x44	2845	
HL3	HANDLAUF - HANDRAIL  	2	145x44	510	
PF2	PFETTEN - PURLINS 	1	80x200	8680	
PF10	PFETTEN - PURLINS 	1	80x200	8680	
PF6	PFETTEN - PURLINS 	1	80x200	8680	
PF3	PFETTEN - PURLINS 	1	80x200	7980	
PF7	PFETTEN - PURLINS 	1	80x200	7980	
PF4	PFETTEN - PURLINS 	1	80x200	5120	
PF8	PFETTEN - PURLINS 	1	80x200	5120	
PF5	PFETTEN - PURLINS 	1	80x200	4420	
PF1	PFETTEN - PURLINS 	1	80x200	4420	
PF9	PFETTEN - PURLINS 	1	80x200	4420	
	DACHBRETTER - ROOF BOARDS		226+3	113x18	4060
	FUSSBODENBRETTER - FLOOR BOARDS		18+2	113x28	5855
	FUSSBODENBRETTER - FLOOR BOARDS		43	113x28	4555
	FUSSBODENBRETTER - FLOOR BOARDS		58	113x28	2390
	FUSSBODENBRETTER - FLOOR BOARDS		18	113x28	1925
Kood	Hansa Holiday F 720x820+VD 70 Material		File	Hansa Holiday F 720x820+VD 70.dwg 6/10	

Pos	Teileliste/Specification Hansa Holiday F 720x820+VD 70		Stck Pcs.	Profil Profile (mm)	Länge Length (mm)
	TERRASSENBRETT (imprägniert) - TERRACE BOARD (impregnated)		13+1	120x28	4065
	TERRASSENBRETT (imprägniert) - TERRACE BOARD (impregnated)		42	120x28	3995
	DECKENLEISTEN - CEILING STRIPS			15x28	72.0 lfm/rm
	FUSSBODENLEISTEN - FLOOR STRIPS			14x55	60.0 lfm/rm
A70-1	ADAPTER 70		2	106x120	945
G02-1	GIEBELBRETT - GABLE BOARD 18x120	 18.5° 	4	18x120	4140
G01-1	GIEBELBRETT - GABLE BOARD 18x95	 18.5° 	4	18x95	4140
G06-1	GIEBELDECKLEISTEN - GABLE COVER STRIPS 18x58	 	4	18x58	4140
G08-1	GIEBELLEISTEN - GABLE STRIPS 18x58	 18.5° 	4	18x58	4140
T01-1	TRAUFBRETT - EAVES BOARD 18x95		6	18x95	4233
T06-1	TRAUFELEISTEN - EAVES STRIPS 18x40	 	6	18x40	26.0 lfm/rm
TL70-1	T-LEISTEN - T-STRIPS 70		2	45x70	490
TL70-2	T-LEISTEN - T-STRIPS 70		4	45x70	1030
TL70-3	T-LEISTEN - T-STRIPS 70		8	45x70	1165
TL70-4	T-LEISTEN - T-STRIPS 70		4	45x70	1975
TL70-5	T-LEISTEN - T-STRIPS 70		4	45x70	2043
TP120-1	STÜTZPFOSTE - SUPPORT POST 120x120	 	4	120x120	2160
DBAND-1	DICHTUNGSBAND (letzte Bohlenkranz Seitenwände) - SEAL TAPE (upper log on sidewalls)	 		13.0m-2st	26.0 lfm/rm
GS	GIEBELSEGMENT - GABLE DIAMOND		2		
SH	SCHLAGHÖLZER - MOUNTING PIECES		3		
VS	Verbindungsstreifen für verbinden der Wandbohlen - Connecting strip for connecting the wall parts		36		
VP3	Verstellbare Pfostenstütze - Adjustable post support M20		4		
KN01	die Fliese mit Nagel 2.0x40 (für Zapfenfüllung) - A tile with a nail 2.0x40 (to support a tenon)		4		
LMT01	Schlagmutter - Impact nut M8		8		
NG04	NÄGEL - NAILS 2.5x50 Dachbretter - Roof boards		2260		
NG05	NÄGEL - NAILS 2.5x60 Fussbodenbretter - Floor boards Terrassenbretter - Terrace boards		2824		
Kood	Hansa Holiday F 720x820+VD 70	Material	File	Hansa Holiday F 720x820+VD 70	DL 70 Entw 7/10

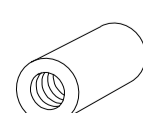
Pos	Teileliste/Specification Hansa Holiday F 720x820+VD 70		Stck Pcs.	Profil Profile (mm)	Länge Length (mm)
SR32	Schrauben - Screws 3.0x30	Deckenleisten - Ceiling strips Fußbodenleisten - Floor strips Traufenleisten - Eaves strips	 310		
SR37	Schrauben - Screws 3.5x45	Giebelbretter - Gable boards Giebeldeckleisten - Gable cover strips Giebelsegment - Gable diamond Traufenbretter - Eaves boards Verbindungsstreifen - Connecting strips Handlauf - Handrail Fenster- und Türleisten - Window and door strips	 676		
SR44	Schrauben - Screws 4.0x60	Wasserleisten - Rain strips (WL1)	 32		
SR57	Schrauben - Screws 5.0x100	Fundamenthölzer - Foundation beams Stützpfeiler - Support posts	 346		
SR55	Schrauben - Screws 5.0x70	Pfostenstützen - Post supports	 32		
ML1	Metallstange - Metal bar		4	D10	1170
ML2	Metallstange - Metal bar		2	D10	1040
ML3	Metallstange - Metal bar		4	D10	900
ML4	Metallstange - Metal bar		4	D10	830
ML5	Metallstange - Metal bar		2	D10	770
ML6	Metallstange - Metal bar		6	D10	630
ML7	Metallstange - Metal bar		22	D10	360
KL-1	Gewindestange - Threaded rod M12- für die Pfetten - for purlins	 10			200
MUT26	Mutter - Nut M12 U-Scheibe - Washer Ø30- für die Pfetten - for purlins	 20			
KL1	Gewindestange - Threaded Rod M8	 4			2000
KL2	Gewindestange - Threaded Rod M8	 14			945
KL3	Gewindestange - Threaded Rod M8	 2			540
KL4	Gewindestange - Threaded Rod M8	 6			405
KL5	Gewindestange - Threaded Rod M8	 4			393
KL6	Gewindestange - Threaded Rod M8	 14			270
KV M UT M8	Mutter - Nut M8	 80			
KV S EIB M8X25	U-Scheibe - Washer M8 Ø25	 80			
KV MU TJ M8	Befestigungsmutter - Fixing nut M8	 4			
Kood	Hansa Holiday F 720x820+VD 70		File	Hansa Holiday F 720x820+VD 70	
	Date			DWG 8/10	

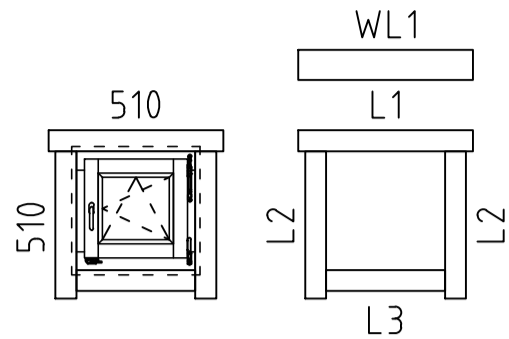
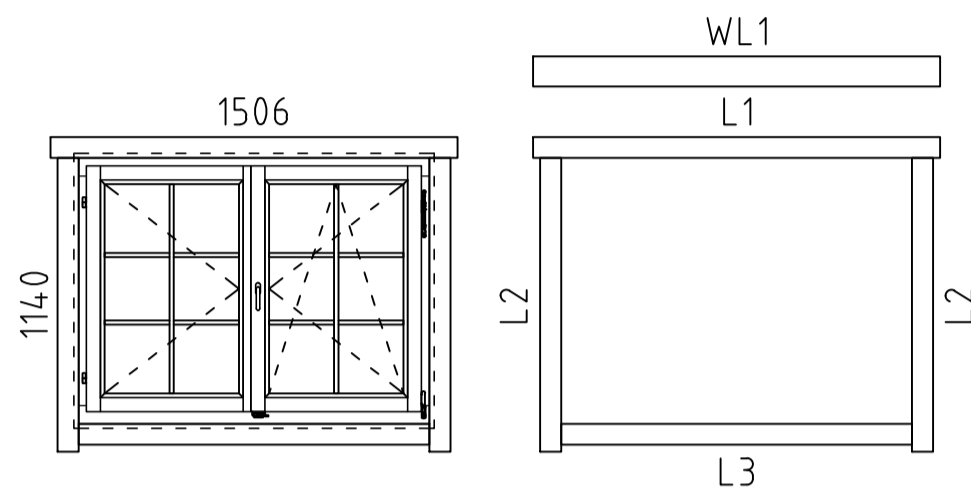
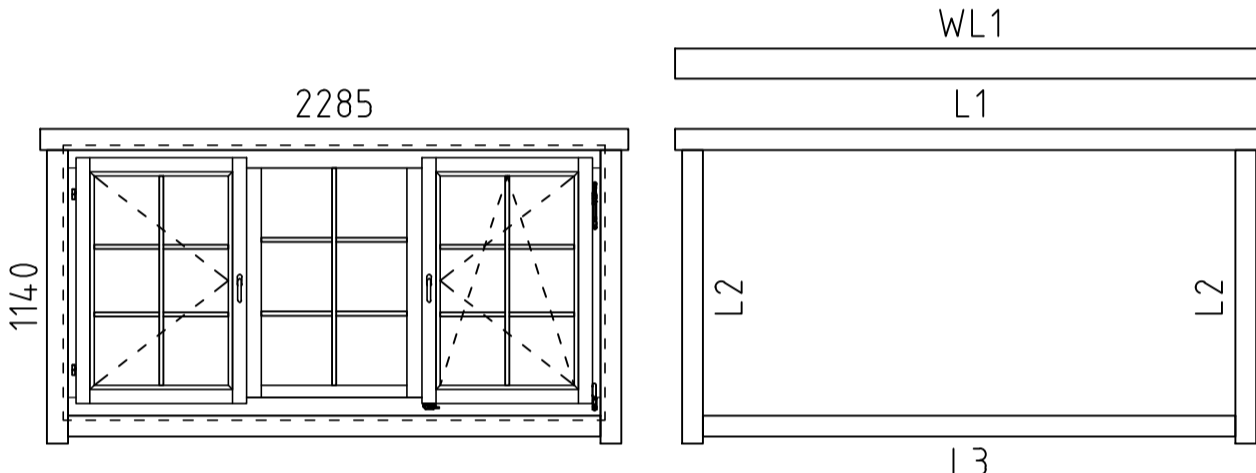
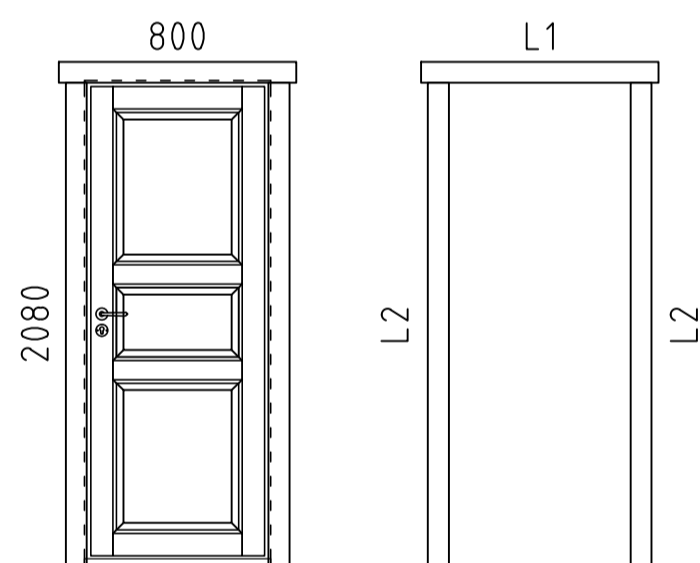
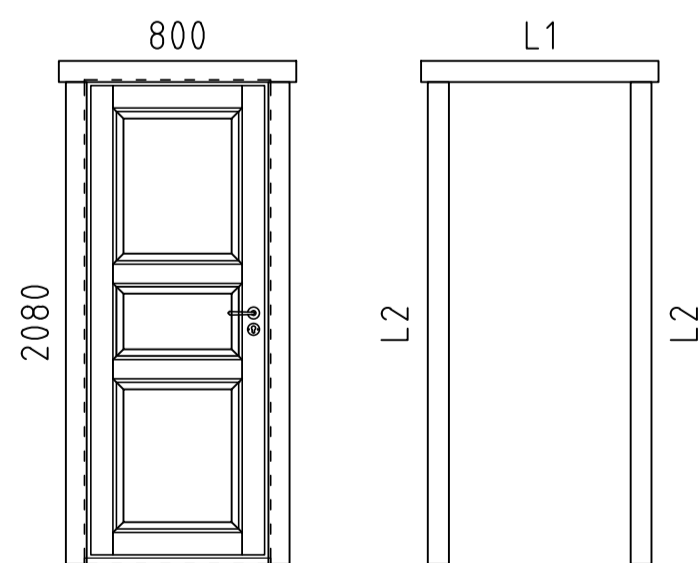
Pos	Teileliste/Specification Hansa Holiday F 720x820+VD 70	Stck Pcs.	Profil Profile (mm)	Länge Length (mm)
FENSTER/WINDOW Q5	W5-S70P-0XT-05100510	1		
	 <p>RA68-1 / W101-PT</p> <p>L1 18x90 L=750mm 2x L2 18x90 L=630mm 4x L3 18x90 L=510mm 2x ✓ WL1 36x129 L=750mm 1x</p>			
FENSTER/WINDOW Q5	W5-D70P-06T-15061140	4		
	 <p>RA68-5 / W206-PT</p> <p>L1 18x90 L=1745mm 2x L2 18x90 L=1260mm 4x L3 18x90 L=1505mm 2x ✓ WL1 36x129 L=1745mm 1x</p>			
FENSTER/WINDOW Q5	W5-T70P-06T-22851140	2		
	 <p>RA68-9 / W302-PT</p> <p>L1 18x90 L=2525mm 2x L2 18x90 L=1260mm 4x L3 18x90 L=2285mm 2x ✓ WL1 36x129 L=2525mm 1x</p>			
TÜR/DOOR	D0-I70R-XXX-08002080	1		
	 <p>SU3_LPT / D913-RX</p> <p>L1 18x90 L=1020mm 2x L2 18x90 L=2070mm 4x ✓</p> <p>DIN rechts / Right handed</p>			
TÜR/DOOR	D0-I70L-XXX-08002080	2		
	 <p>SU3_LPT / D913-LX</p> <p>L1 18x90 L=1020mm 2x L2 18x90 L=2070mm 4x ✓</p> <p>DIN links / Left handed</p>			

Montageanleitung für T-Leisten / Installing the door and window supports / Tenderliistu paigaldusjuhend.

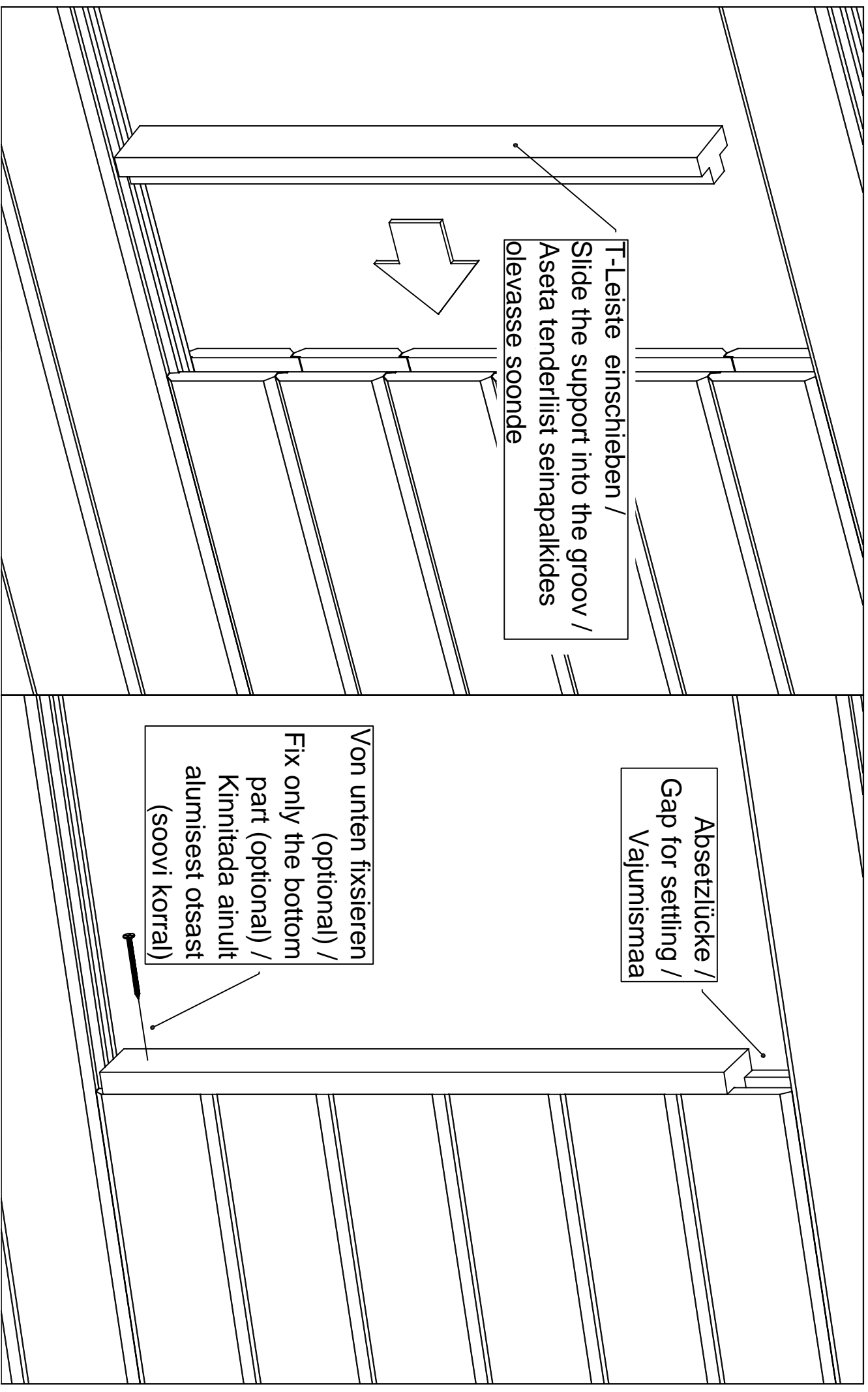

Aken	Q4-Q6	-	paigaldusjuhis
Window	Q4-Q6	-	assembly instructions
Fenster	Q4-Q6	-	Montageanleitung

5-10mm

3.5x45

Lõika mõõtu
Cut to length
Absägen
- 10mm / -20mm

NB!

3.5x45

Vihmaliist / Rain strip / Wasserleiste

Q5-Q6

*Silikoon

*Silicon

*Silikon

*Vajumispilu

*Settling gap

*Senkungs spalt

ca 40-50mm

NB!

- Monteerida juhul kui ese on välja toodud maja spetsifikatsioonis!
- Install only if the item is listed in the house specification!
- Nur montieren wenn die Leiste in der Teileliste gezeigt ist!

Veepilek / Window sill / Fensterbank

4,2x16

Ukse montaaž / Tür montage / Door assembly
(GH+ / SH)

4.5x90

4.5x90

5mm

3.5x45

Vihmaliist / Head flashing / Regenschutz

Silikoon
Silicon
Silikon

Vajumispilu
Settling gap
Senkungs spalt
40-50mm

NB!

- Monteerida juhul kui ese on välja toodud maja spetsifikatsioonis!
- Install only if the item is listed in the house specification!
- Nur montieren wenn die Leiste in der Teilleiste gezeigt ist!

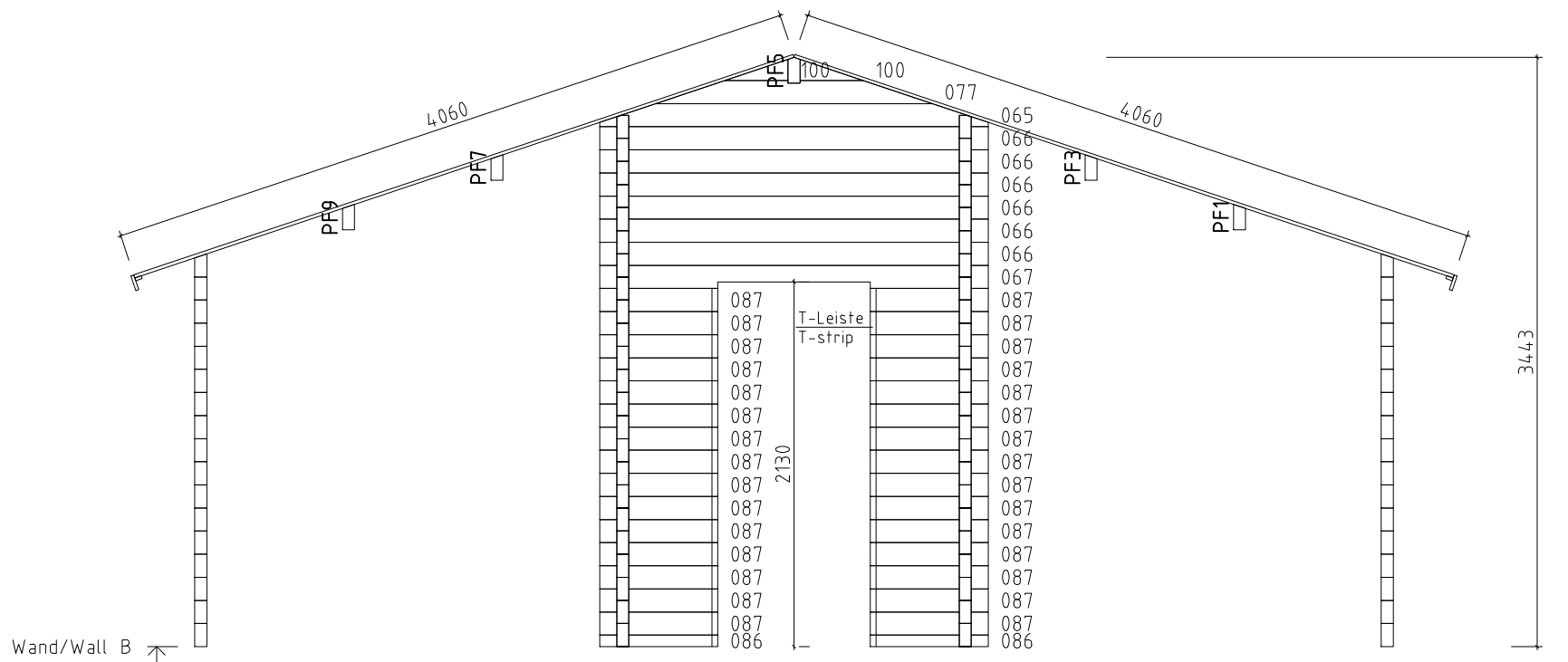

Wand/Wall B ↑

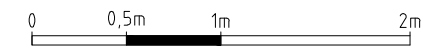
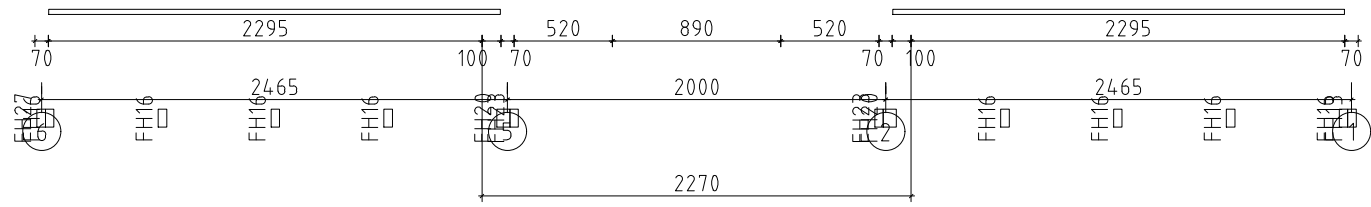

Name		Hansa Holiday F 720x820+VD 70	
Zeichnung/Drawing		WAND/WALL B	
Maßstab/Scale	1:40	Profil/Profile	7.0x13.5
Datum/Date		24.08.2021	

Druck auf/print on A4

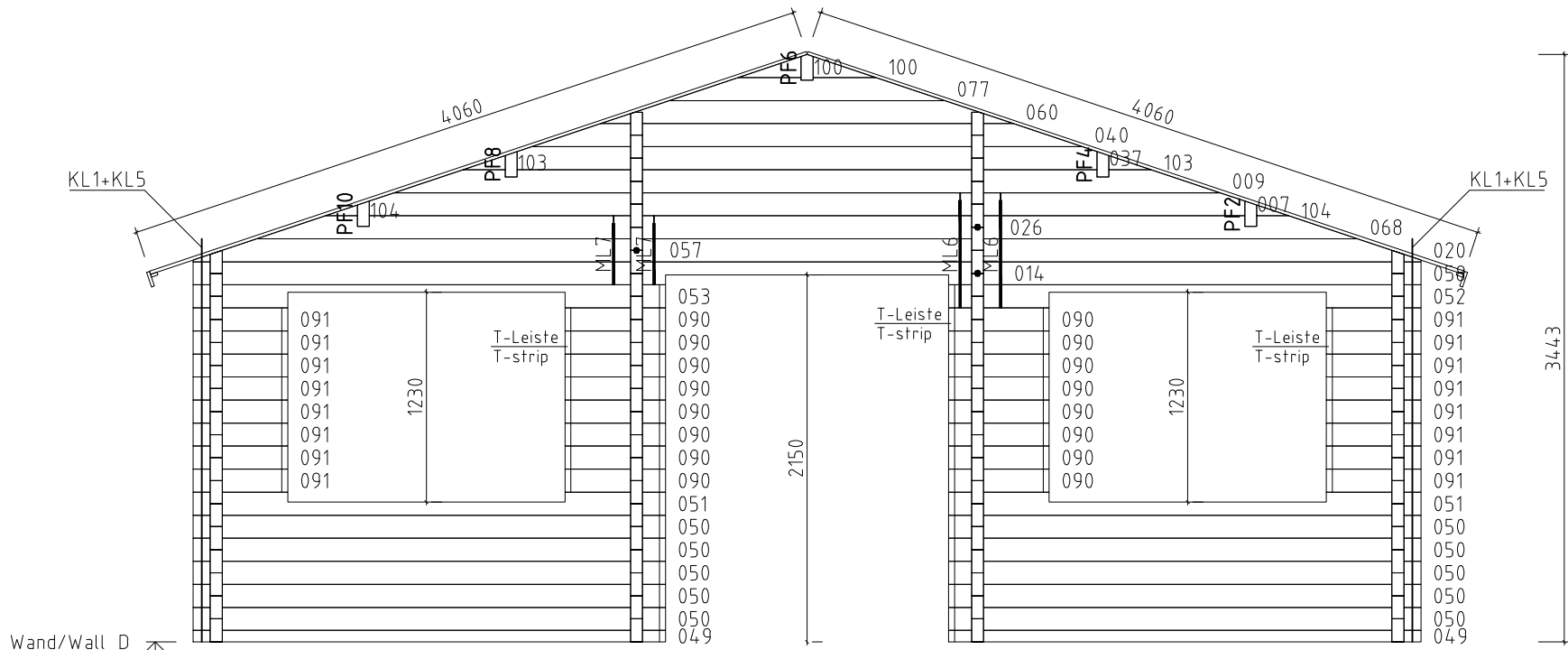

Wand/Wall D

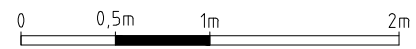
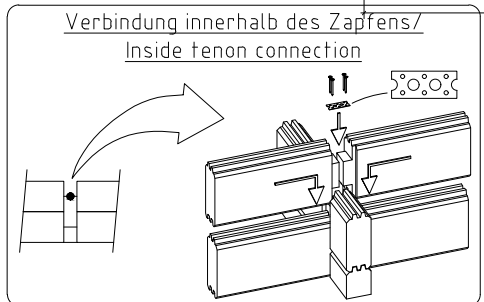
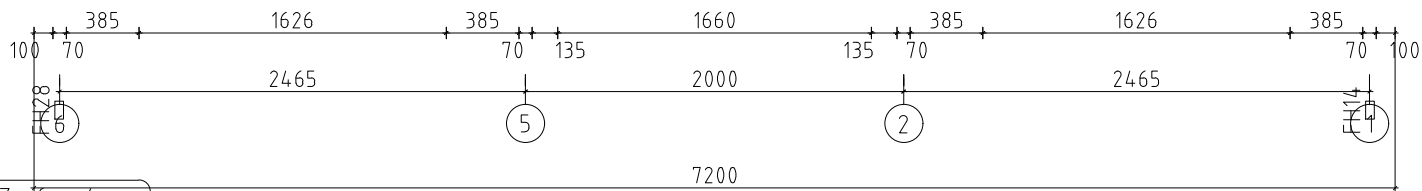

Name	Hansa Holiday F 720x820+VD 70		
Zeichnung/Drawing	WAND/WALL D		
Maßstab/Scale	1:40	Profil/Profile	7.0x13.5
Datum/Date	24.08.2021		

Druck auf/print on A4

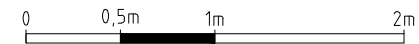
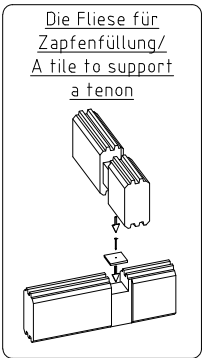
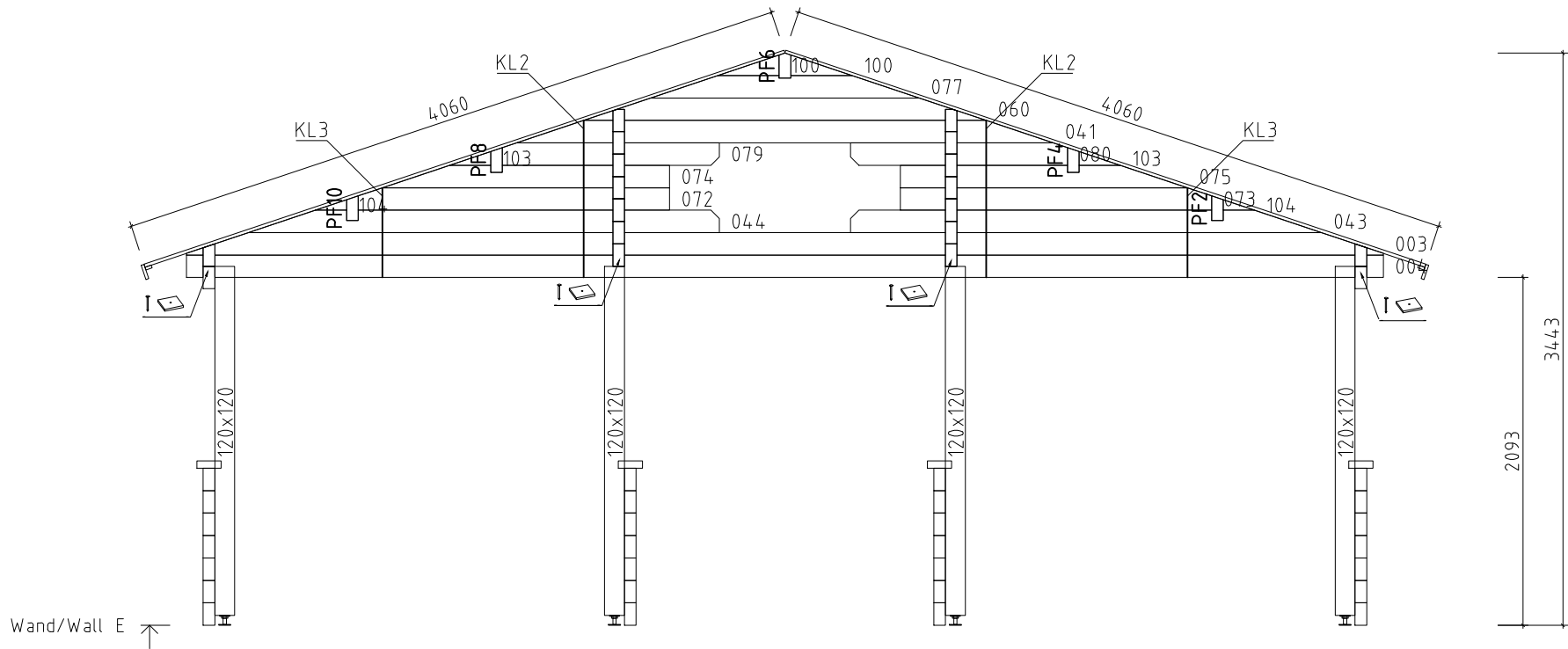

Name	Hansa Holiday F 720x820+VD 70		
Zeichnung/Drawing	WAND/WALL E		Druck auf/print on A4
Maßstab/Scale	1:40	Profil/Profile	7.0x13.5
Datum/Date	24.08.2021		

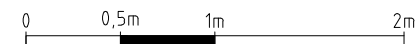
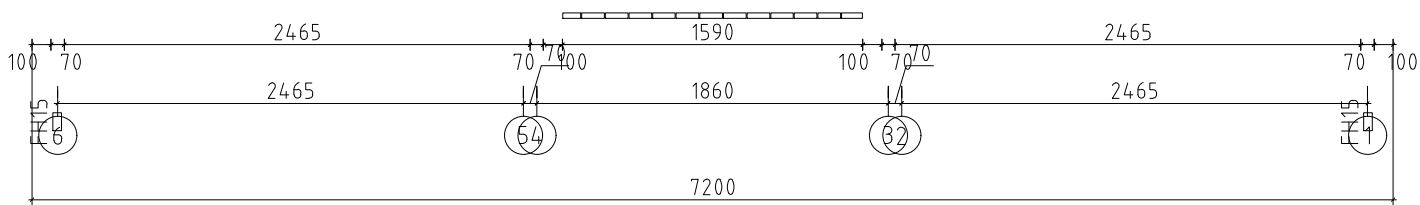
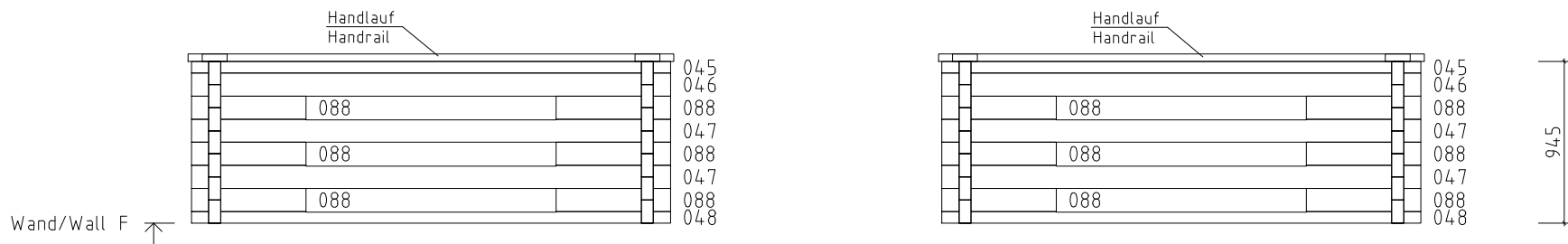
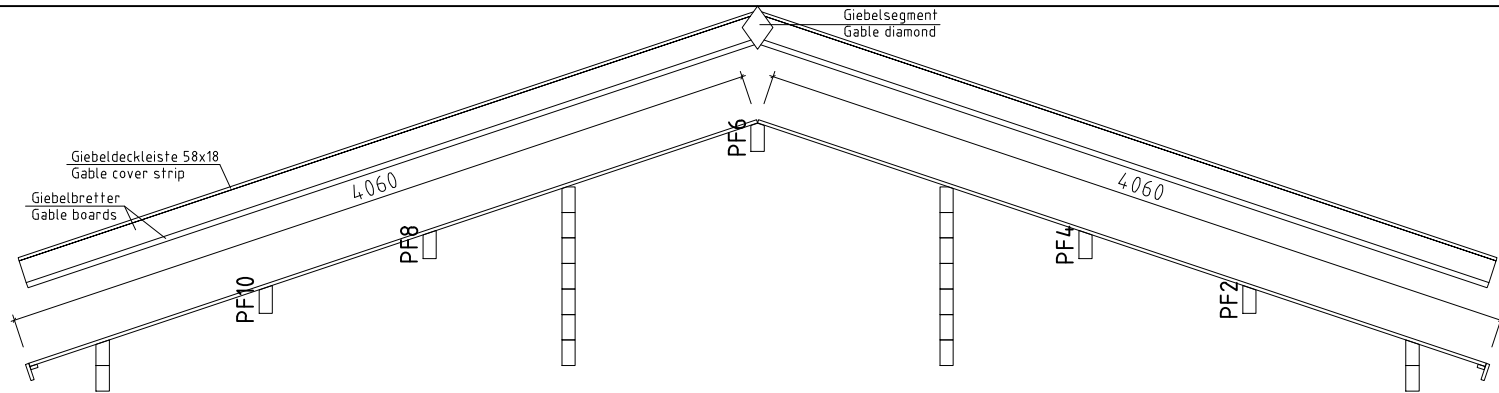

Name	Hansa Holiday F 720x820+VD 70		
Zeichnung/Drawing	WAND/WALL F		Druck auf/print on A4
Maßstab/Scale	1:40	Profil/Profile	7.0x13.5
Datum/Date	24.08.2021		

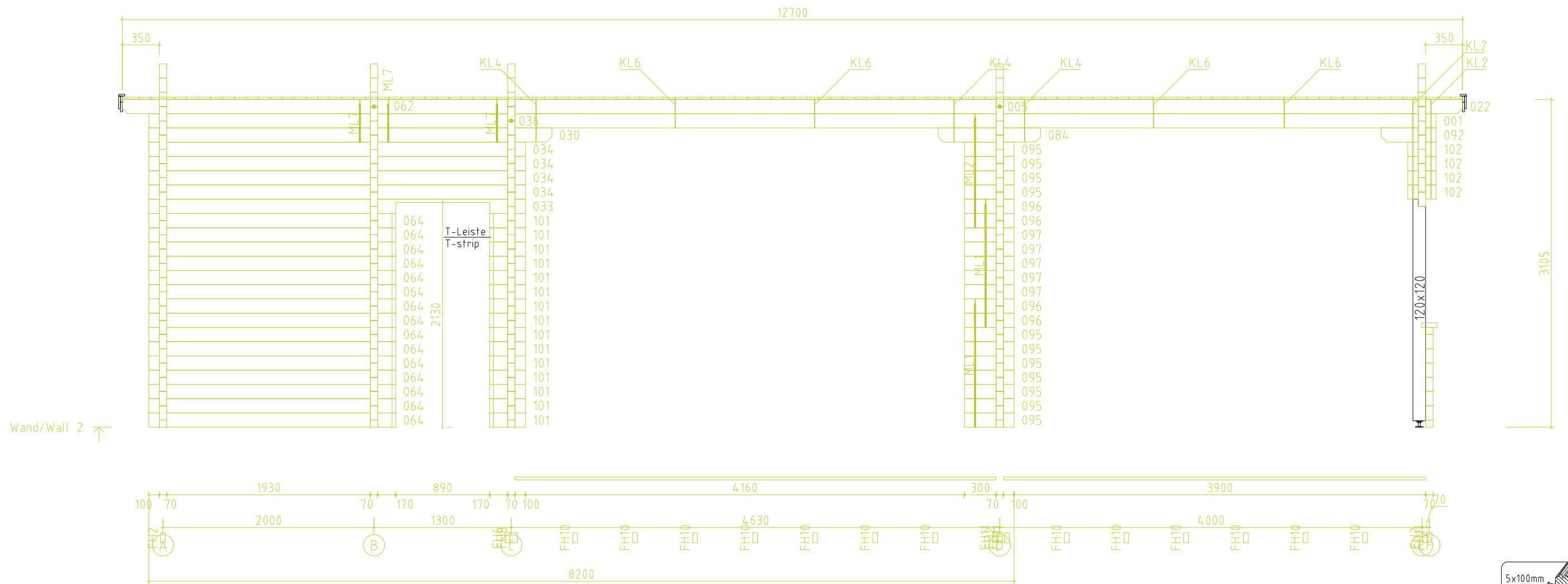

Wand/Wall 2 ↗

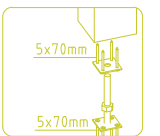
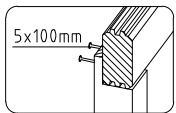
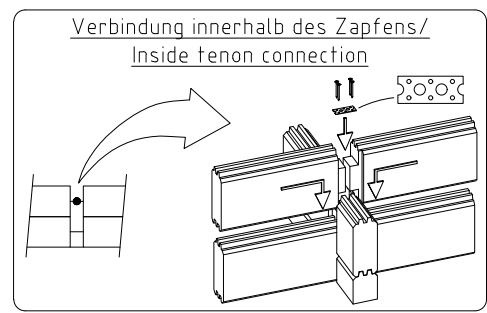

Name	Hansa Holiday F 720x820+VD 70		
Zeichnung/Drawing	WAND/WALL 2		
Maßstab/Scale	1:40	Profil/Profile	7.0x13.5
		Datum/Date	24.08.2021

Druck auf/print on A3

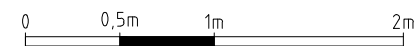
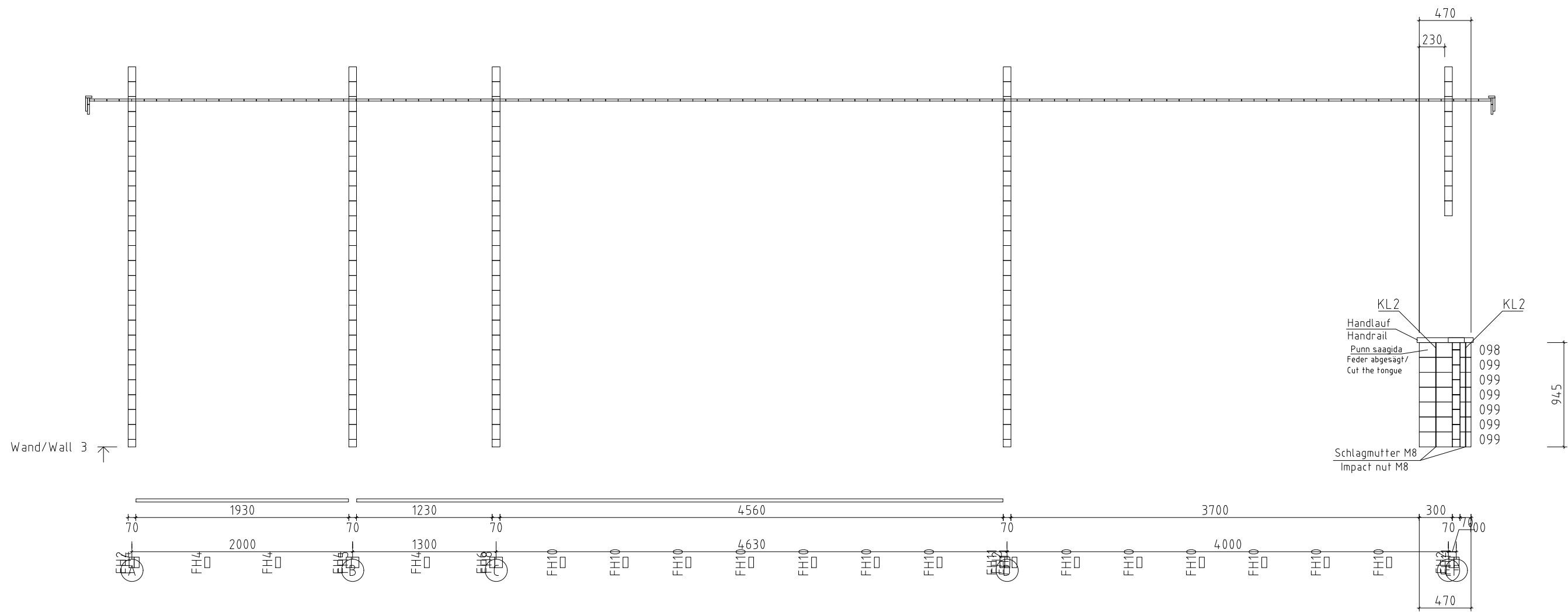

Name	Hansa Holiday F 720x820+VD 70		
Zeichnung/Drawing	WAND/WALL 3		Druck auf/print on A3
Maßstab/Scale	1:40	Profil/Profile	7.0x13.5
		Datum/Date	24.08.2021

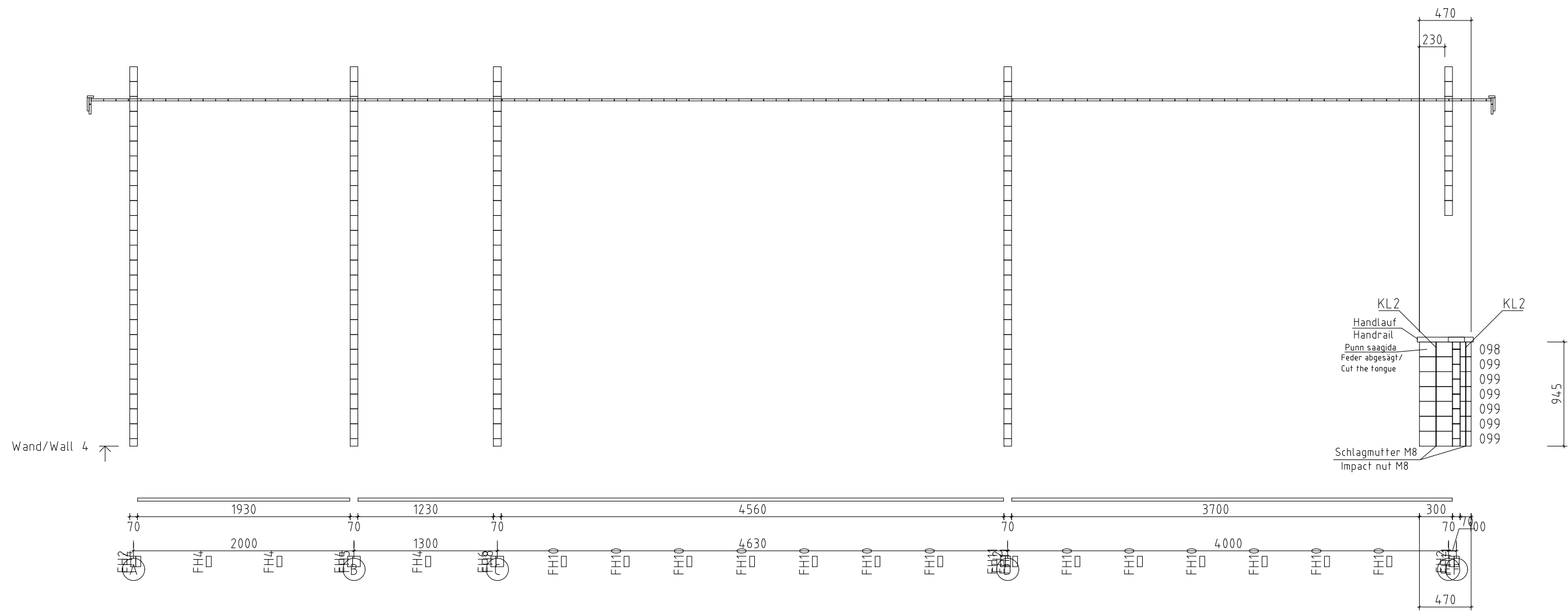

Name	Hansa Holiday F 720x820+VD 70		
Zeichnung/Drawing	WAND/WALL 4		Druck auf/print on A3
Maßstab/Scale	1:40	Profil/Profile	7.0x13.5
		Datum/Date	24.08.2021

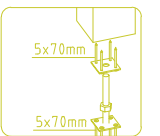
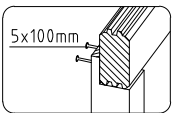
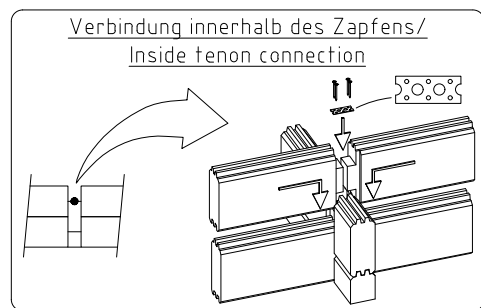
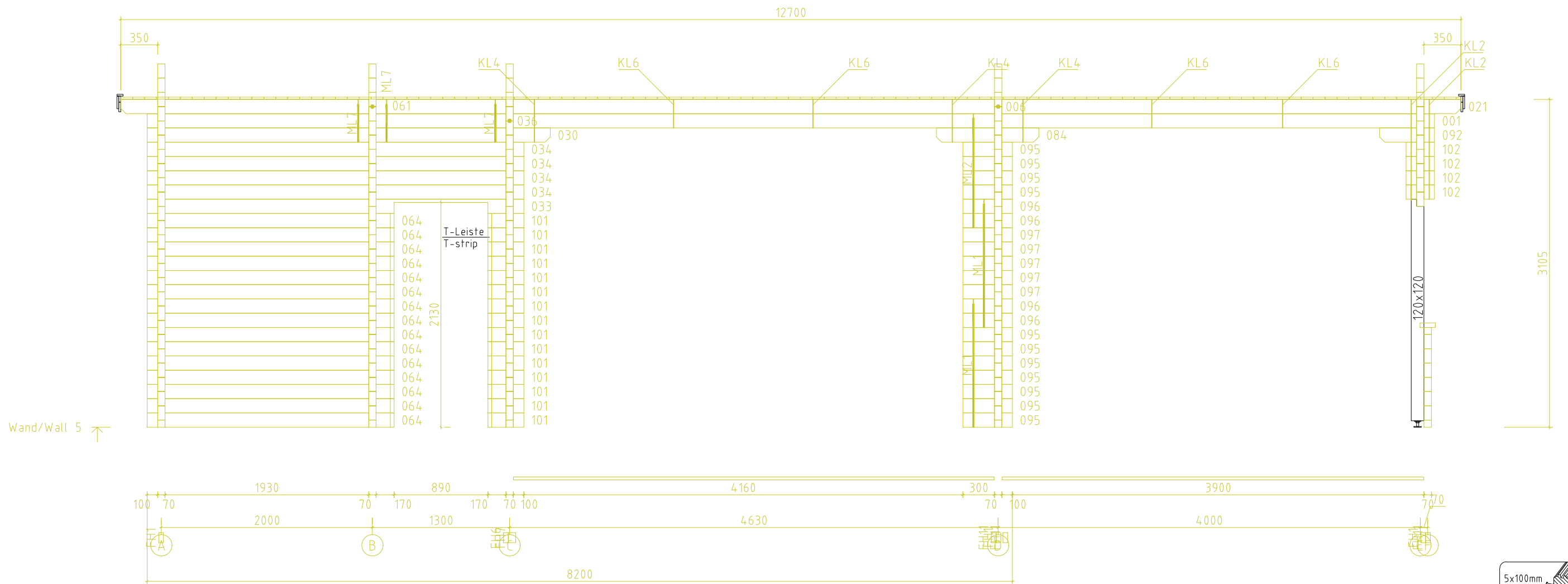

Name	Hansa Holiday F 720x820+VD 70		
Zeichnung/Drawing	WAND/WALL 5		
Maßstab/Scale	1:40	Profil/Profile	7.0x13.5
Datum/Date	24.08.2021		

Druck auf/print on A3

