

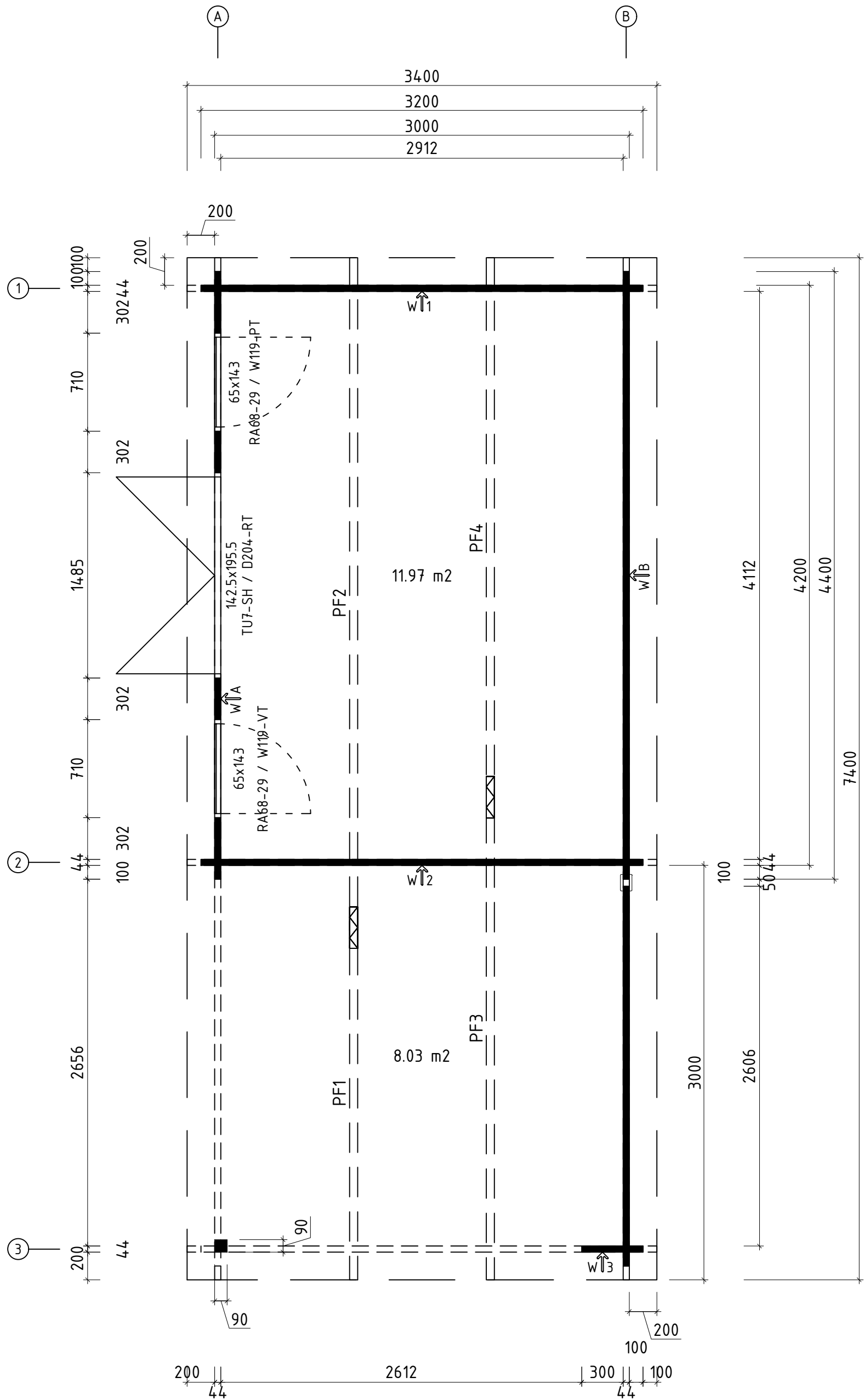







Name	Jacob D 320x440+VD+Terr_44		
Zeichnung/Drawing	3D		
Profil/Profile	4.4x13.5	Datum/Date	05.07.2021

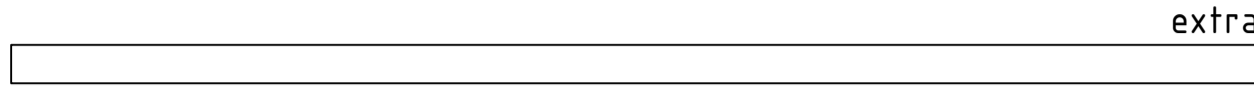
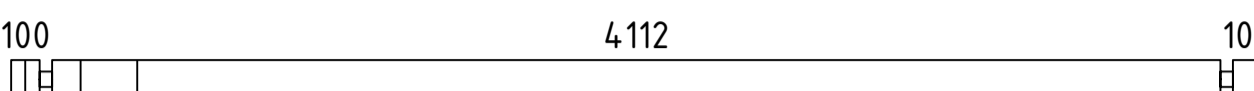
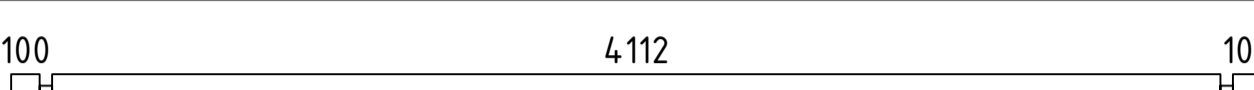
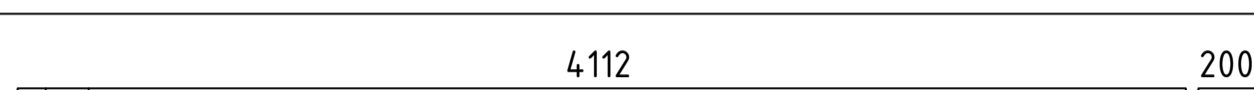
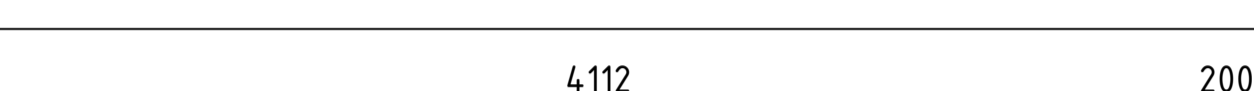
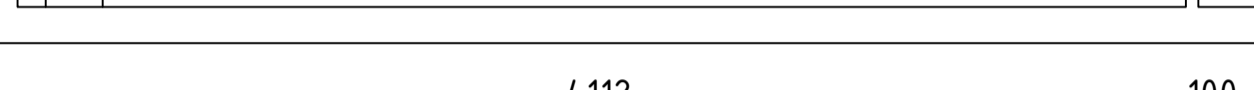
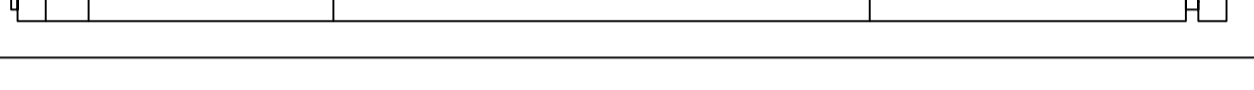
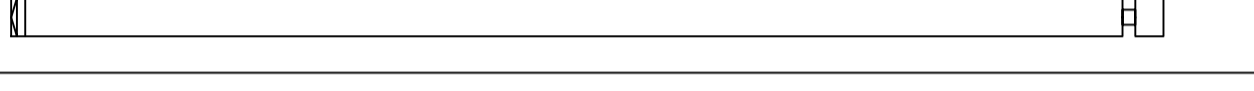
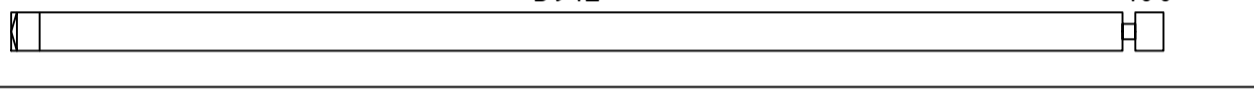
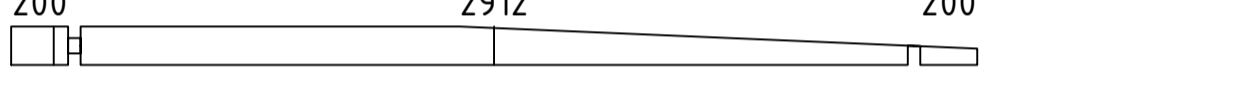
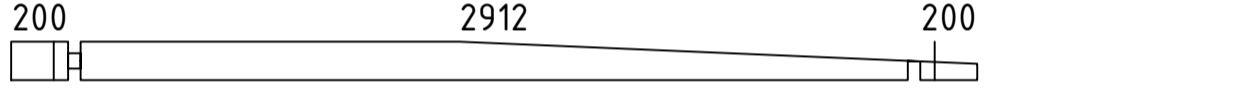
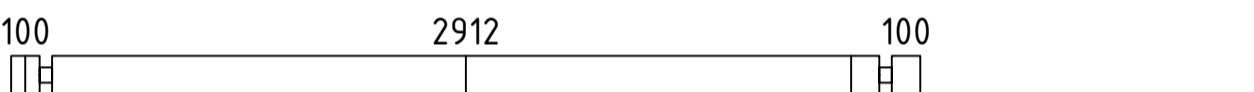

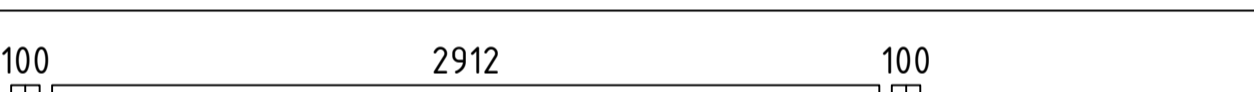

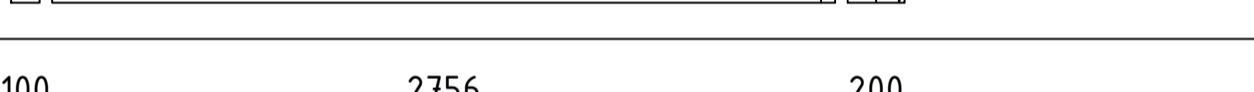
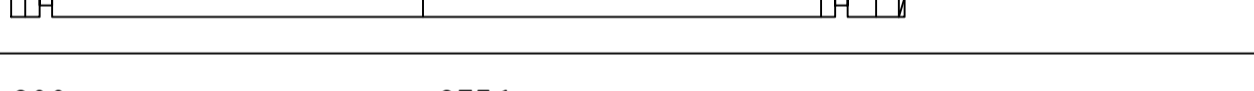
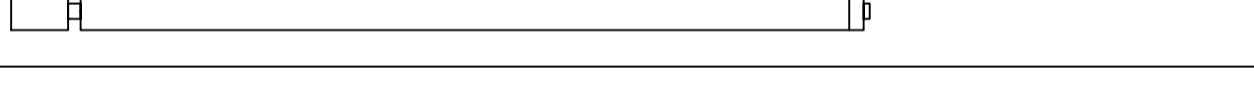
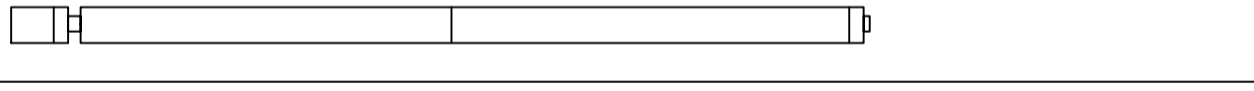
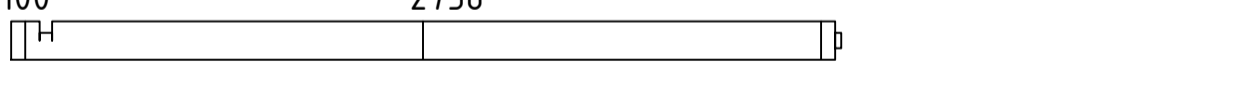
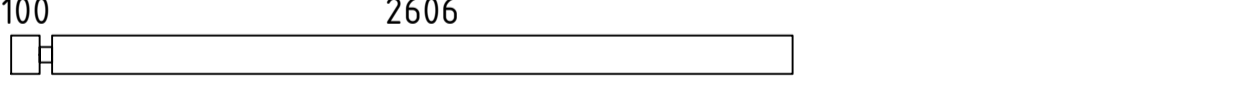



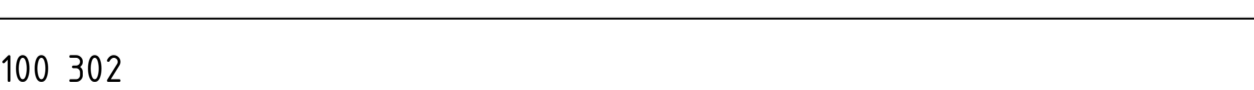
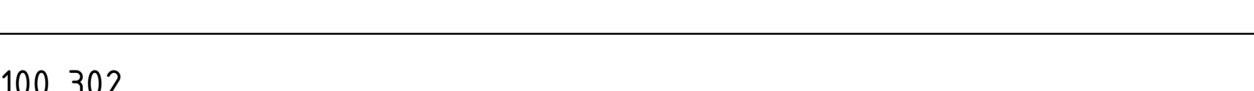

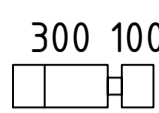
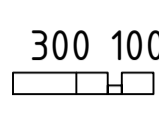
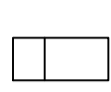
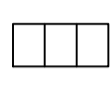

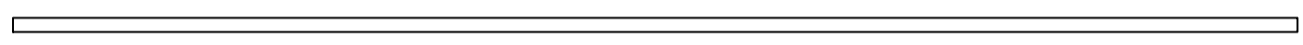
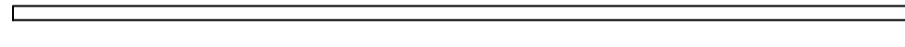
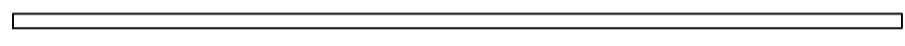
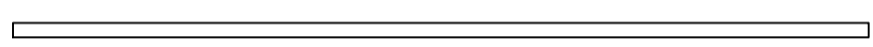

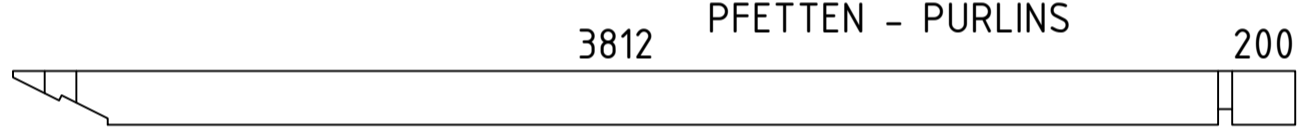
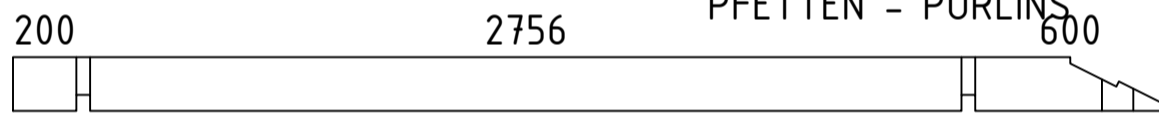
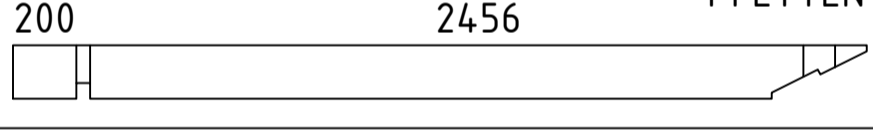
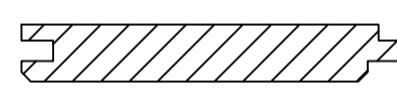

* Fenster und Türen sind ohne Sprossen/
Windows and doors are without muntins

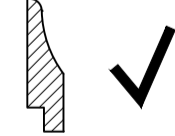
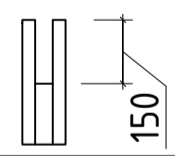
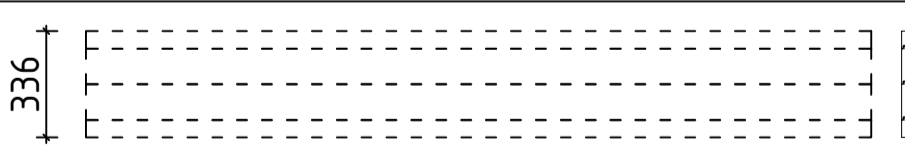
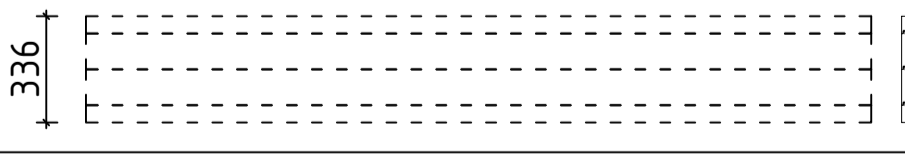
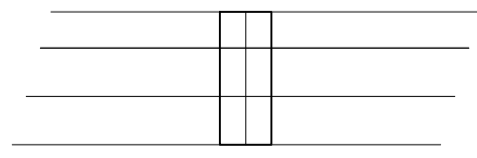
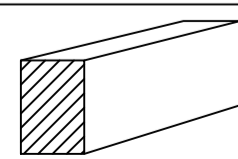
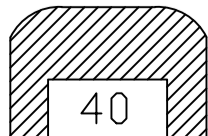

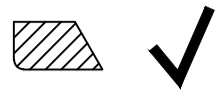
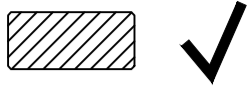
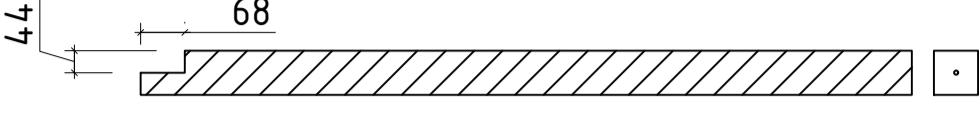
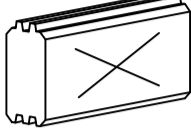
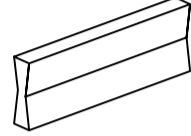
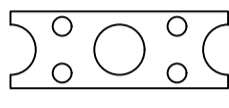
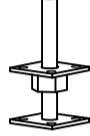
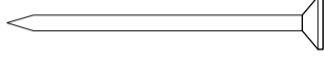
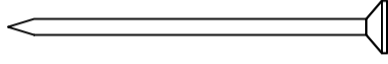
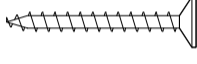
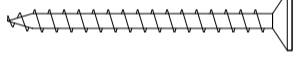
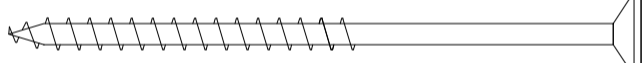
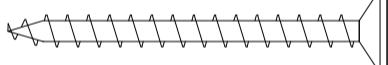
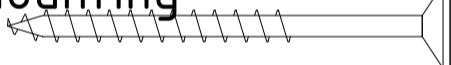
Q5 – Qualitätsklasse für Fenster und Türen/
Quality class for windows and doors

Name	Jacob D 320x440+VD+Terr_44		
Zeichnung/Drawing	Grundplan, Plan		
Profil/Profile	4.4x13.5	Datum/Date	05.07.2021

Pos	Teieliste/Specification Jacob D 320x440+VD+Terr_44	Stck. Pcs.	Profil Profile (mm)	Länge Length (mm)
	Achtung! Die Giebelbohlen können teilweise schon vormontiert sein! Bitte beachten - diese erscheinen nicht ganz so wie in der Teieliste beschrieben.			
	Notice! The gable pieces can be partly pre-assembled! Please notice - those differ from the description given in the specification list.			
000		1	44x135	4400
001		1	44x135	4400
002		14	44x135	4400
003		1	44x126	4378
004		1	44x135	4378
005		1	44x135	4278
006		1	44x135	4056
007		1	44x135	4056
008		1	44x135	3400
009		2	44x135	3400
010		1	44x135	3200
011		32	44x135	3200
012		2	44x68	3200
013		1	44x135	3144
014		1	44x135	3144
015		1	44x135	3022
016		1	44x126	3022
017		1	44x135	2922
018		15	44x135	2750
019		3	44x68	1578
020		6	44x135	1458
021		2	44x135	1458
022		21	44x135	446
023		1	44x135	446
024		8	44x135	444
025		4	44x135	444

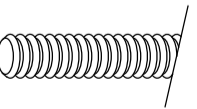
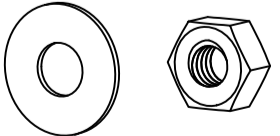
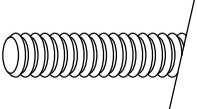
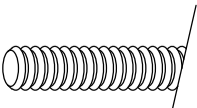
Pos	Teileliste/Specification Jacob D 320x440+VD+Terr_44		Stck. Pcs.	Profil Profile (mm)	Länge Length (mm)
026			3	44x135	444
027			1	44x68	444
028			18	44x135	302
029			4	44x135	302
FH2	FUNDAMENTHOLZ (imprägniert) - FOUNDATION BEAM (impregnated) 		2	70x45	4168
FH5	FUNDAMENTHOLZ (imprägniert) - FOUNDATION BEAM (impregnated) 		4	70x45	4063
FH6	FUNDAMENTHOLZ (imprägniert) - FOUNDATION BEAM (impregnated) 		3	70x45	2840
FH1	FUNDAMENTHOLZ (imprägniert) - FOUNDATION BEAM (impregnated) 		2	70x45	2812
FH4	FUNDAMENTHOLZ (imprägniert) - FOUNDATION BEAM (impregnated) 		4	70x45	2707
FH3	FUNDAMENTHOLZ (imprägniert) - FOUNDATION BEAM (impregnated) 		1	70x45	1485
PF2	PFETTEN - PURLINS 		1	58x170	5000
PF4	PFETTEN - PURLINS 		1	58x170	4056
PF3	PFETTEN - PURLINS 		1	58x170	3644
PF1	PFETTEN - PURLINS 		1	58x170	2700
	DACHBRETTEN - ROOF BOARDS 		66+1	113x18	3305
	FUSSBODENBRETTEN - FLOOR BOARDS 		37+1	113x28	2905
	TERRASSENBRETTEN (imprägniert) - TERRACE BOARDS (impregnated) 		23+1	120x28	2950
	DECKENLEISTEN - CEILING STRIPS 			15x28	23.0 lfm/rm
	FUSSBODENLEISTEN - FLOOR STRIPS 			14x55	15.0 lfm/rm
A44-1	ADAPTER 44 	Obere seite Upper side	1	80x120	2125
BL-1	DACHBLENDEN - PARAPET 336mm 	336	2	18x336	3400
BL-2	DACHBLENDEN - PARAPET 336mm 	336	4	18x336	3718
VL-1	DACHBLENDEN- Verbindungsleisten - PARAPET- connecting strips 		2	18x120	336
BS-1	DACHBLENDEN- Blendenstützen - PARAPET- Parapet support 44x65 		12	44x65	200
UPB-1	DACHBLENDEN- U-Profil für Blenden - PARAPET- U-Profile 			65x44	23.0 lfm/rm
Kood	Jacob D 320x440+VD+Terr_Material	Material	File	Leht	2/4

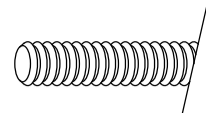
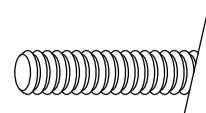
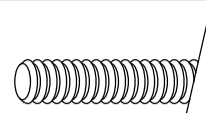
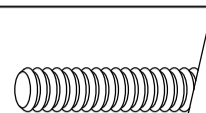
Pos	Teileliste/Specification Jacob D 320x440+VD+Terr_44		Stck. Pcs.	Profil Profile (mm)	Länge Length (mm)
DPL-1	DACHPAPPENLEISTEN - ROOFING FELT STRIPS 15x28			15x28	15.0 lfm/rm
T06-1	TRAUFENLEISTEN - EAVES STRIPS 18x40			18x40	15.0 lfm/rm
TP90-1	STÜTZPFOSTE - SUPPORT POST 90x90		1	90x90	2040
SH	SCHLAGHÖLZER - MOUNTING PIECES		3		
HK2	HOLZ-KLOTZEN für verbinden der Wandbohlen - Wooden wedge for connecting the wall parts (122mm)		2		
VS	Verbindungsstreifen für verbinden der Wandbohlen - Connecting strip for connecting the wall parts		3		
VP2	Verstellbare Pfostenstütze - Adjustable post support M16		1		
NG04	NÄGEL - NAILS 2.5x50 Dachbretter - Roof boards Fussbodenbretter - Floor boards		528		
NG05	NÄGEL - NAILS 2.5x60 Terrassenbretter - Terrace boards		720		
SR32	Schrauben - Screws 3.0x30 Deckenleiste - Ceiling strips Fussbodenleiste - Floor strips Traufenleiste - Eaves strips 40x18 Dachpappenleiste - Roofing felt Verbindungsleisten - Connecting strips (Parapet)		152		
SR37	Schrauben - Screws 3.5x45 U-Profil für Blenden - Parapet U-Profile Verbindungsstreifen - Connecting strip Türleisten - Window/Door strips		140		
SR57	Schrauben - Screws 5.0x100 Fundamenthölzer - Foundation beams		64		
SR53	Schrauben - Screws 5.0x60 Stützpfofte - Support post		4		
SR55	Schrauben - Screws 5.0x70 Blendenbefestigung - Parapet mounting Stützpfofte - Support post		90		
ML1	Metallstange - Metal bar		2	D10	1040
ML2	Metallstange - Metal bar		4	D10	900
ML3	Metallstange - Metal bar		1	D10	830
ML4	Metallstange - Metal bar		2	D10	490
ML5	Metallstange - Metal bar		3	D10	360
ML6	Metallstange - Metal bar		1	D10	350
KL-1	Gewindestange - Threaded rod M12- für die Pfetten - for purlins		4		170
MUT26	Mutter - Nut M12 U-Scheibe - Washer Ø30- für die Pfetten - for purlins		8		
KL1	Gewindestange - Threaded Rod M8		4		2000
KL2	Gewindestange - Threaded Rod M8		2		460
Kood	Jacob D 320x440+VD+Terr_44	Material	File	Leht	3/4

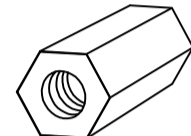
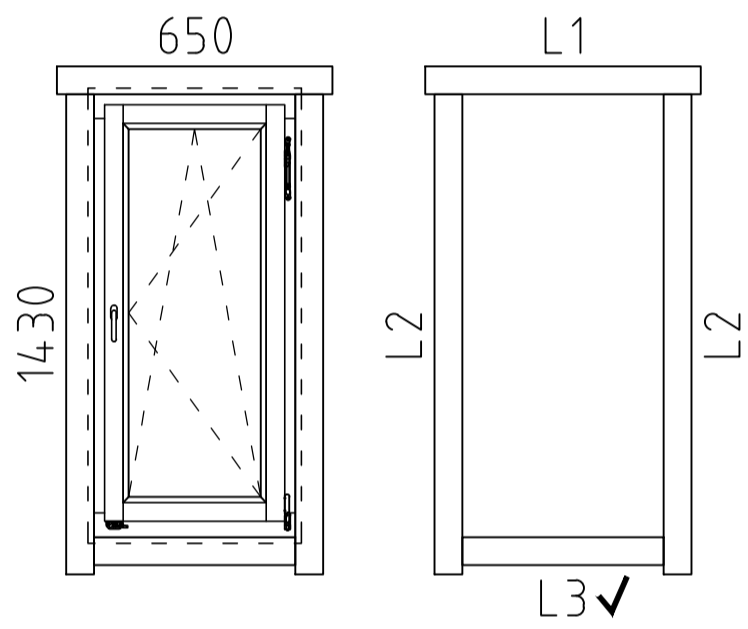
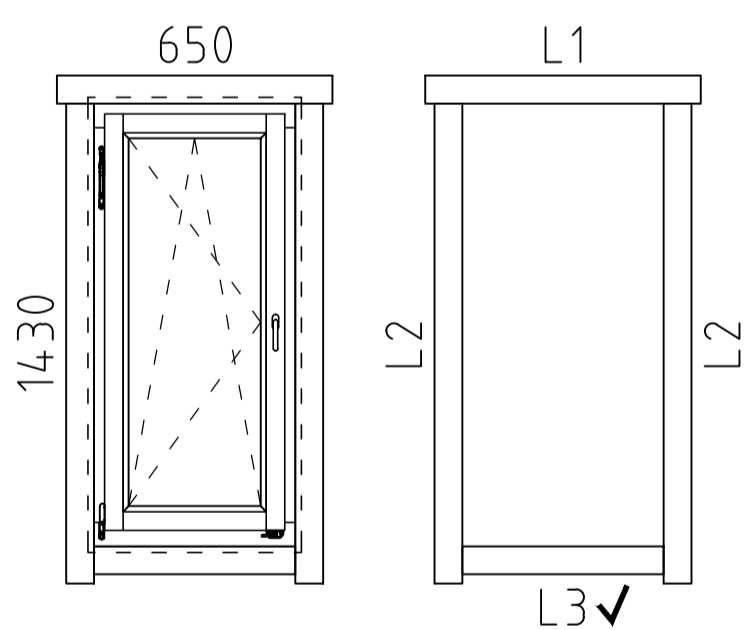
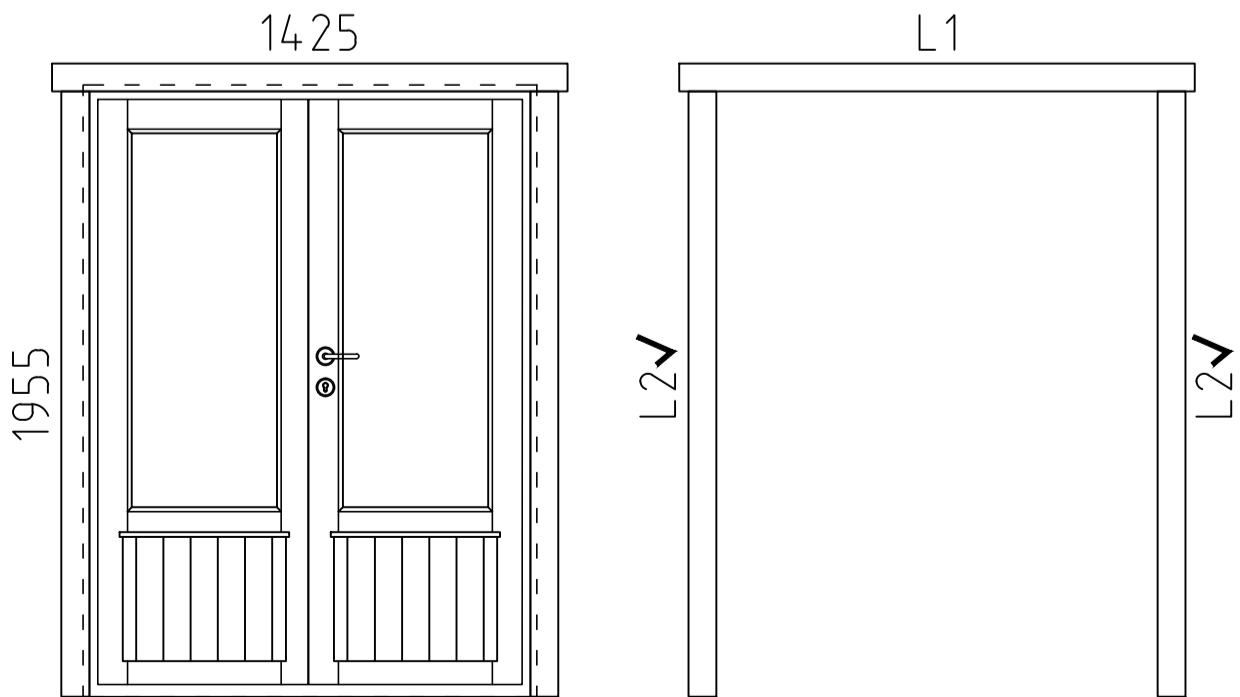
Pos	Teileliste/Specification Jacob D 320x440+VD+Terr_44		Stck. Pcs.	Profil Profile (mm)	Länge Length (mm)
KL3	Gewindestange - Threaded Rod M8		2		396
KL4	Gewindestange - Threaded Rod M8		2		393
KL5	Gewindestange - Threaded Rod M8		1		338
KL6	Gewindestange - Threaded Rod M8		1		270
KV M UT M8	Mutter - Nut M8		16		
KV S EIB M8X25	U-Scheibe - Washer M8 Ø25		16		
KV MU TJ M8	Befestigungsmutter - Fixing nut M8		4		
	FENSTER/WINDOW Q5	W5-S44P-0XT-06501430	1		
	 <p>RA68-29 / W119-PT</p> <p>L1 18x90 L=890mm 2x L2 18x90 L=1550mm 4x L3 18x90 L=650mm 2x ✓</p> <p>DIN rechts / right handed</p>				
	FENSTER/WINDOW Q5	W5-S44V-0XT-06501430	1		
	 <p>RA68-29 / W119-VT</p> <p>L1 18x90 L=890mm 2x L2 18x90 L=1550mm 4x L3 18x90 L=650mm 2x ✓</p> <p>DIN links / left handed</p>				
	TÜR/DOOR Q5	D5-D44R-7XT-14251955	1		
	 <p>TU7-SH / D204-RT</p> <p>L1 18x90 L=1665mm 2x L2 18x90 L=1955mm 4x ✓</p> <p>DIN rechts/ right handed</p>				
	✓ - Bitte selber anpassen (falls nötig)! / Cut into length on site (if needed)!				
Kood	Jacob D 320x440+VD+Terr_Material	File	Leht		4/4

Aken	Q4-Q6	-	paigaldusjuhis
Window	Q4-Q6	-	assembly instructions
Fenster	Q4-Q6	-	Montageanleitung

5-10mm

3.5x45

Lõika mõõtu
Cut to length
Absägen
- 10mm / -20mm

NB!

3.5x45

Vihmaliist / Rain strip / Wasserleiste

Q5-Q6

*Silikoon
*Silicon
*Silikon

*Vajumispilu
*Settling gap
*Senkungs spalt

ca 40-50mm

NB!

- Monteerida juhul kui ese on välja toodud maja spetsifikatsioonis!
- Install only if the item is listed in the house specification!
- Nur montieren wenn die Leiste in der Teileliste gezeigt ist!

Veeplekk / Window sill / Fensterbank

4,2x16

Ukse montaaž / Tür montage / Door assembly
(GH+ / SH)

4.5x90

4.5x90

5mm

3.5x45

Vihmaliist / Head flashing / Regenschutz

Silikoon
Silicon
Silikon

Vajumispilu
Settling gap
Senkungs spalt
40-50mm

NB!

- Monteerida juhul kui ese on välja toodud maja spetsifikatsioonis!
- Install only if the item is listed in the house specification!
- Nur montieren wenn die Leiste in der Teilleiste gezeigt ist!

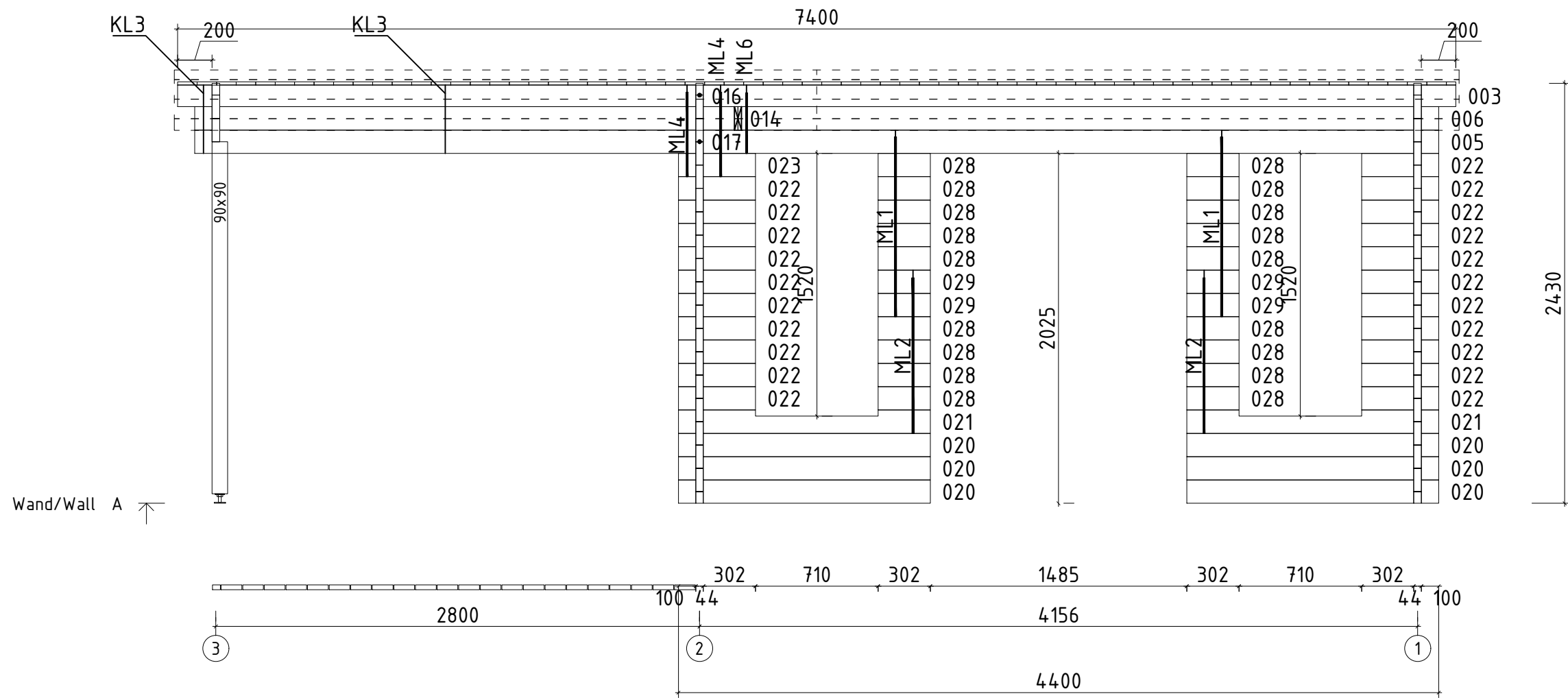

Wand/Wall A ↑

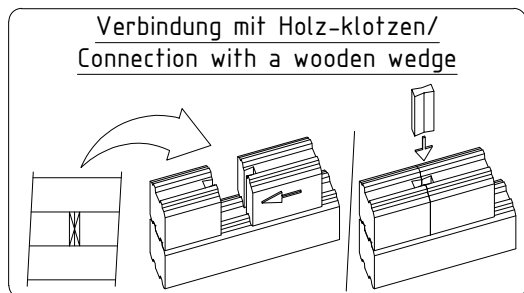
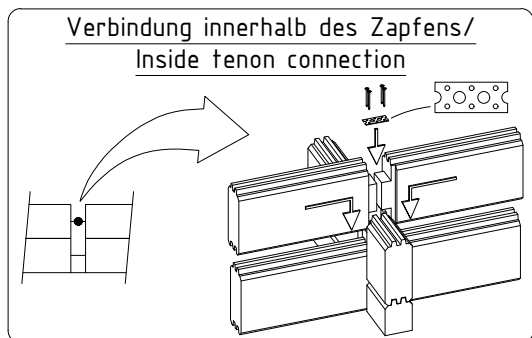
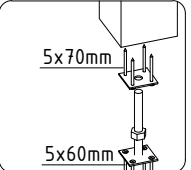
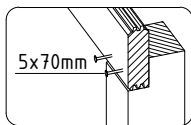

Name	Jacob D 320x440+VD+Terr_44		
Zeichnung/Drawing	WAND/WALL A		
Profil/Profile	4.4x13.5	Datum/Date	05.07.2021

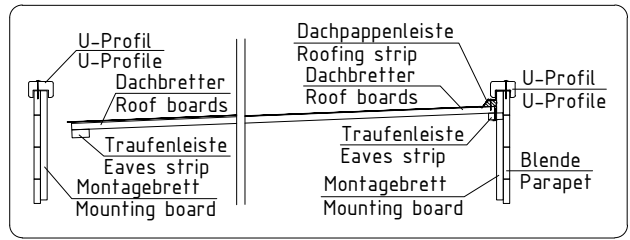
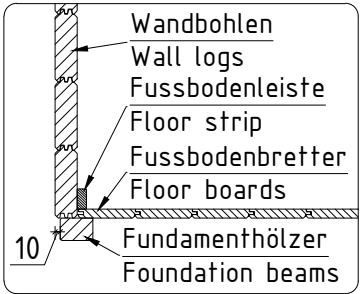
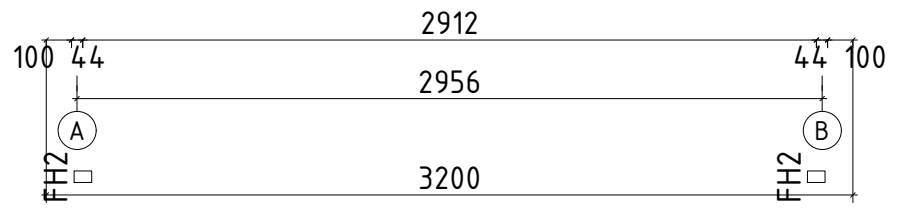
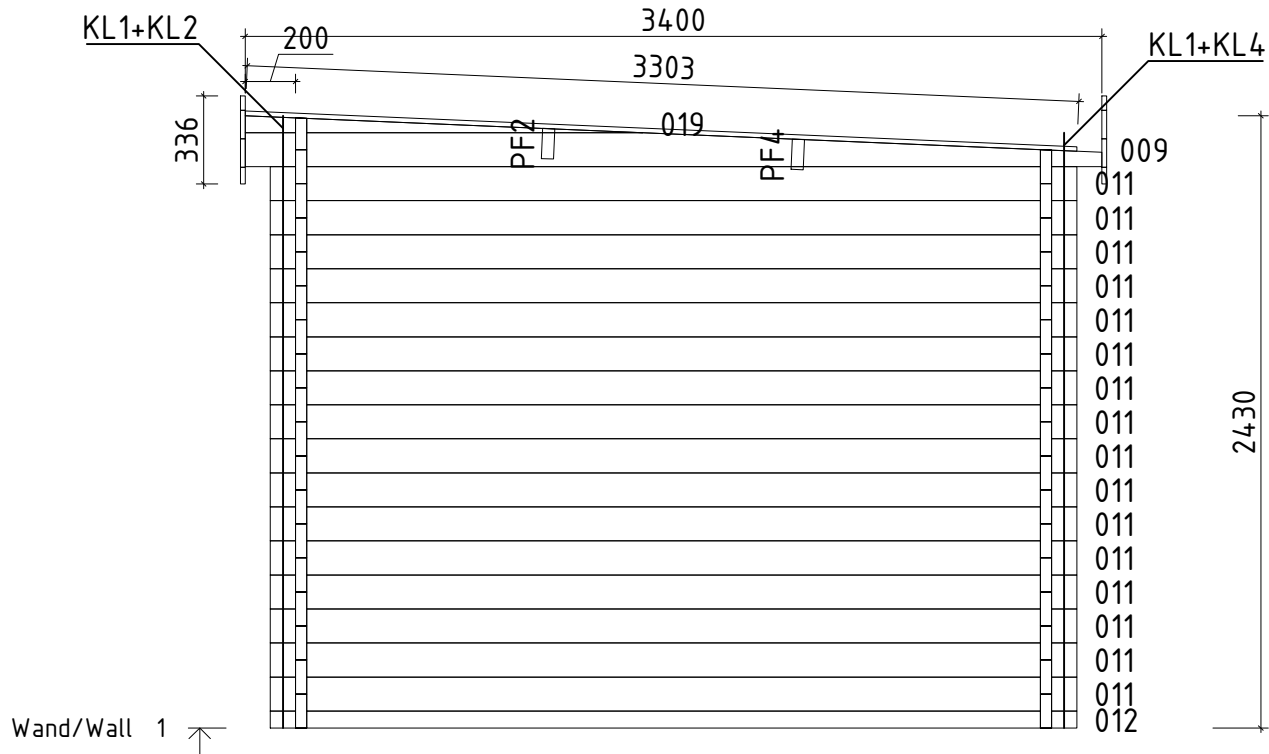

Name	Jacob D 320x440+VD+Terr_44	
Zeichnung/Drawing	WAND/WALL 1	
Profil/Profile	4.4x13.5	Datum/Date 05.07.2021

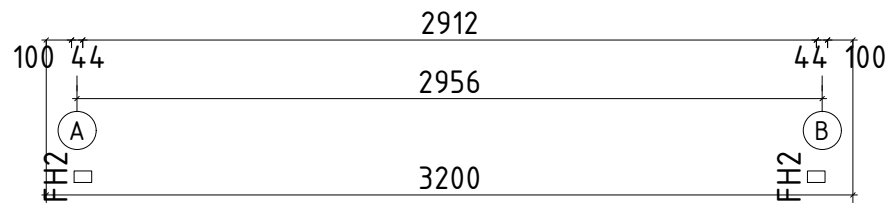
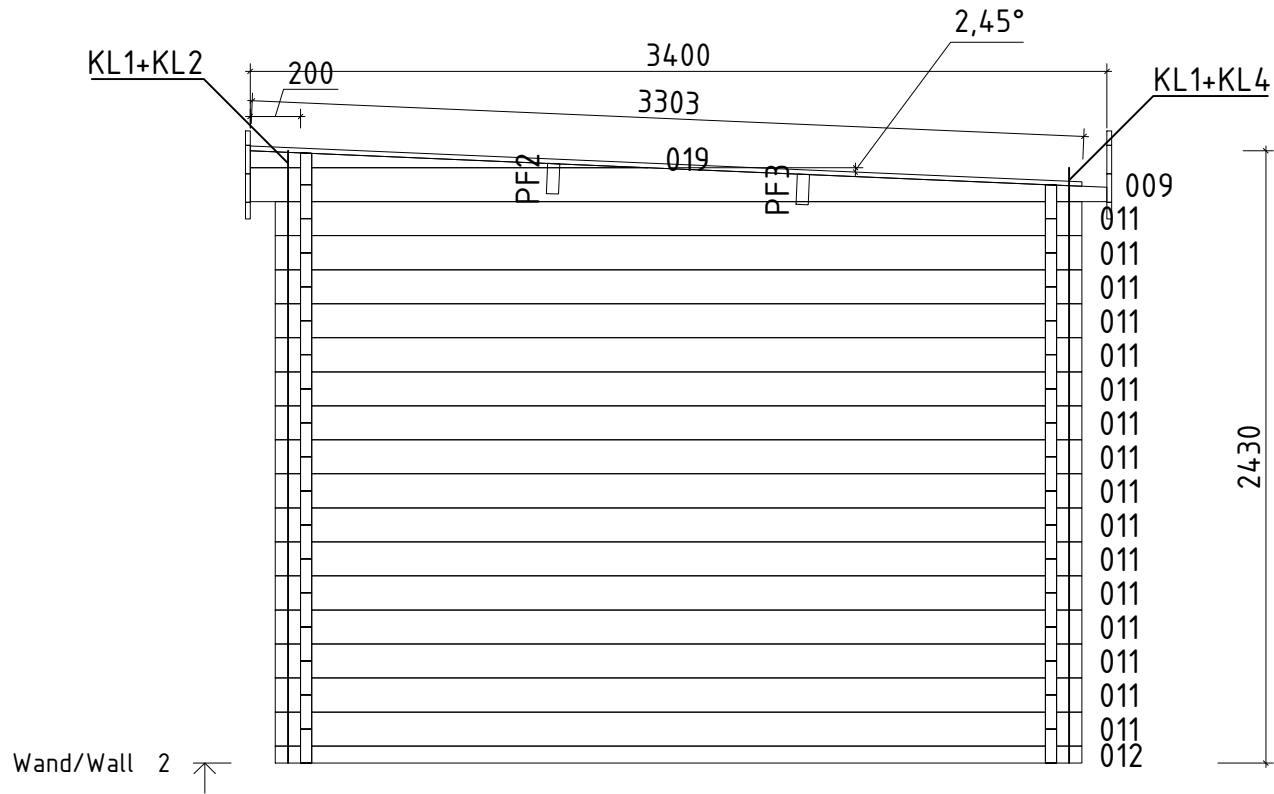

Name	Jacob D 320x440+VD+Terr_44		
Zeichnung/Drawing	WAND/WALL 2		
Profil/Profile	4.4x13.5	Datum/Date	05.07.2021

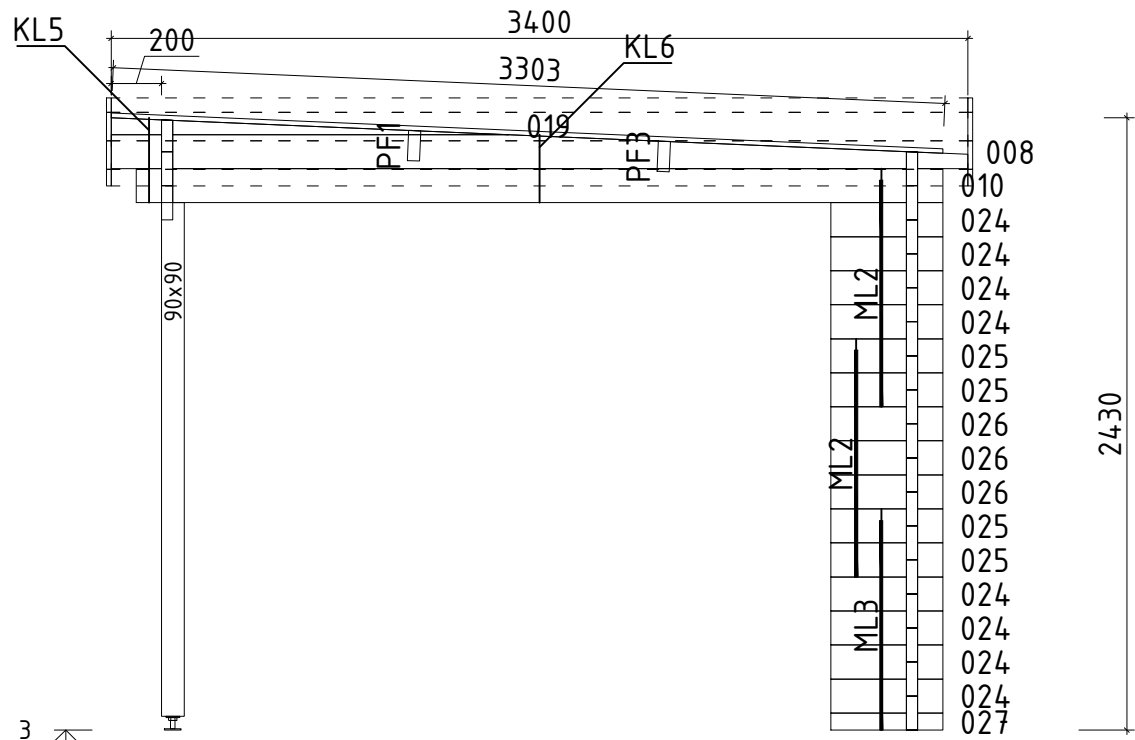

Wand/Wall 3 ↗

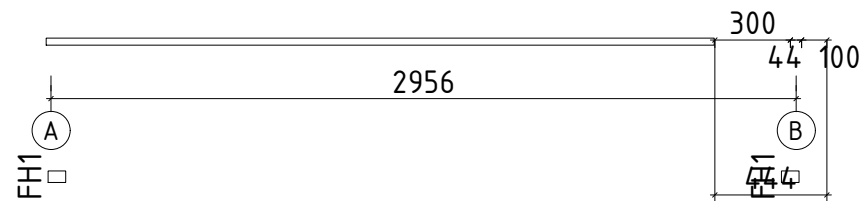

Name	Jacob D 320x440+VD+Terr_44		
Zeichnung/Drawing	WAND/WALL 3		
Profil/Profile	4.4x13.5	Datum/Date	05.07.2021