

Haus Jacob E+VD lässt sich auch spiegelverkehrt aufbauen.  
House Jacob E + VD can be built mirrored.

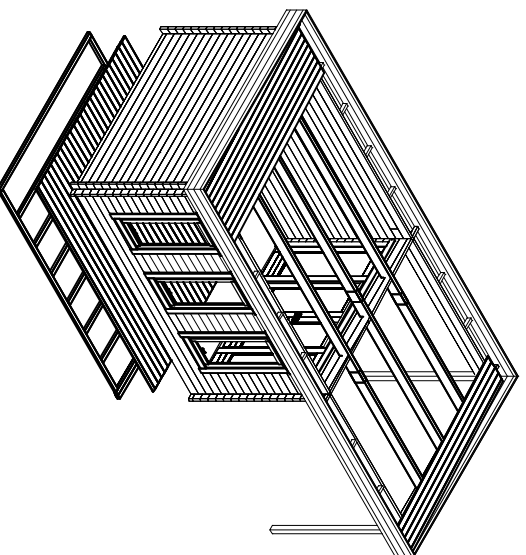

Name

Jacob E 340x440+VD\_44

Zeichnung/Drawing

3D

Blatt/Sheet

Profil/Profile

4.4x13.5

Datum/Date

10.04.2019

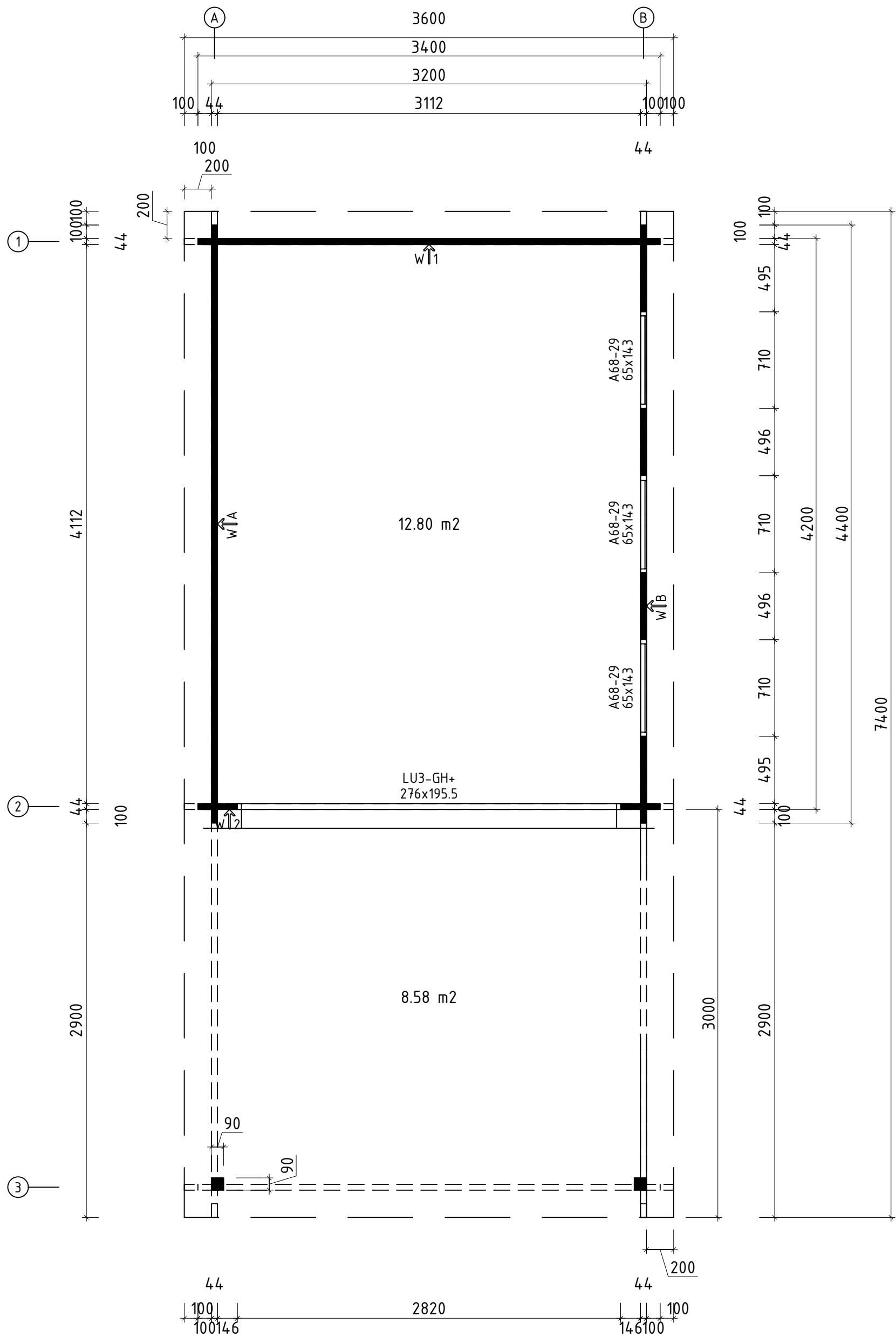





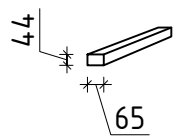
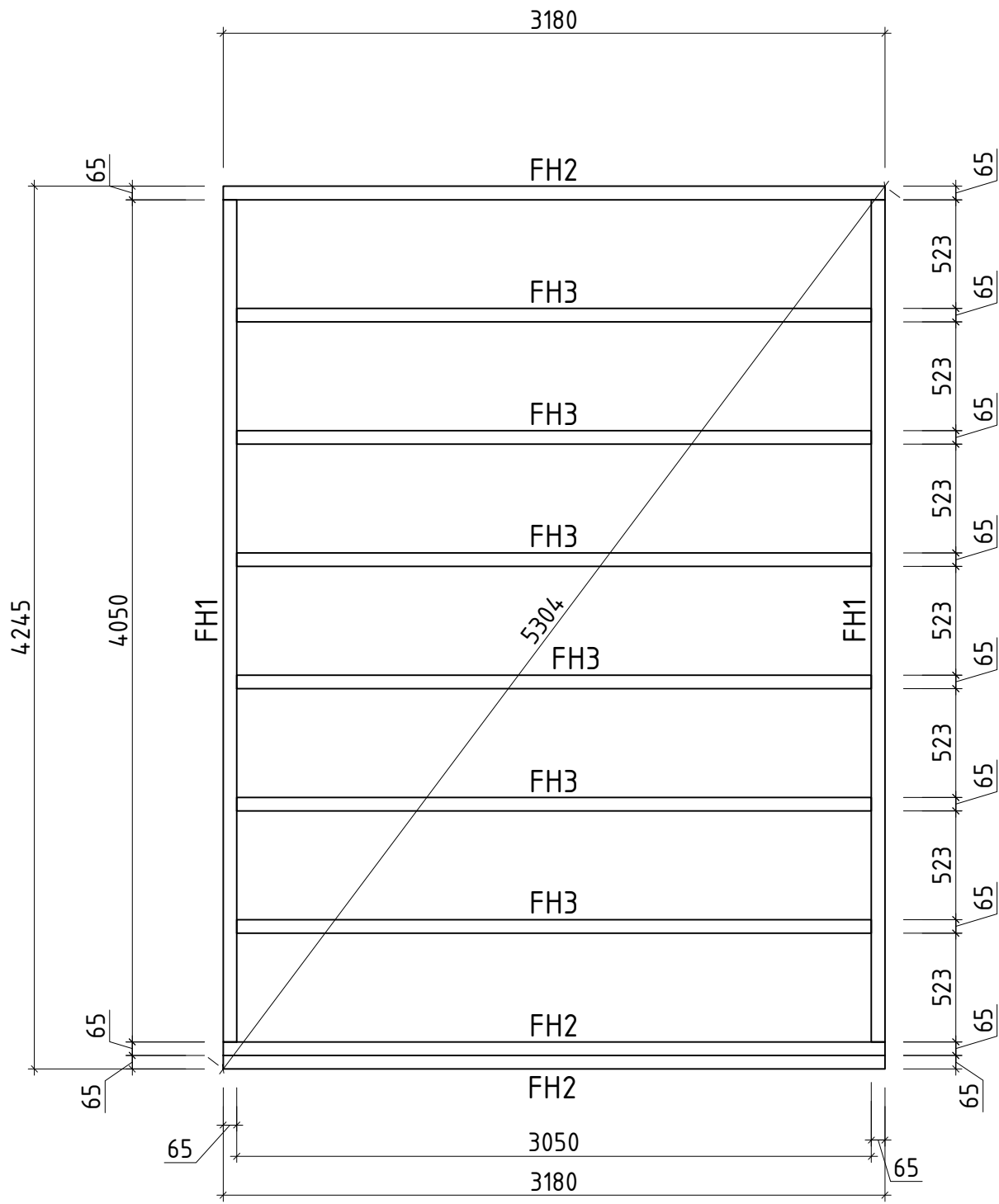



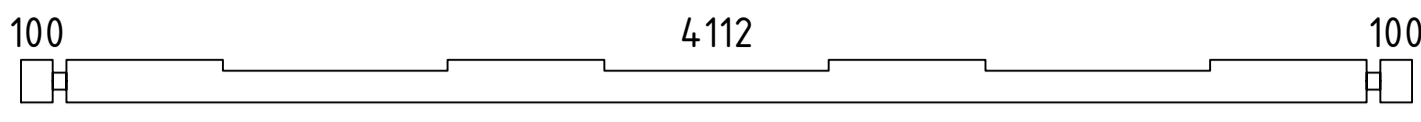
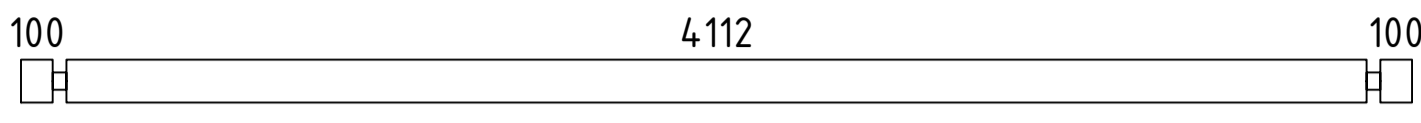
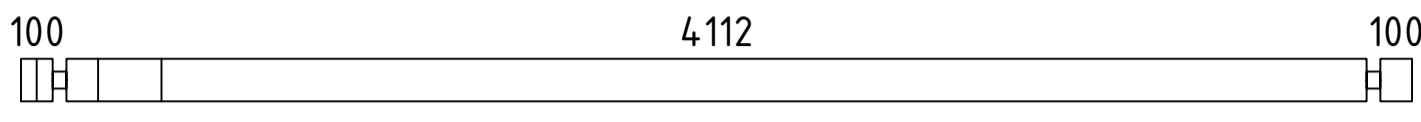
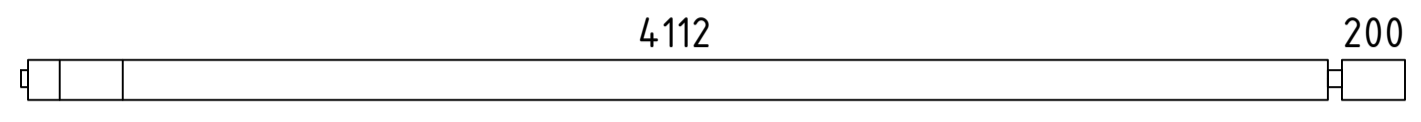
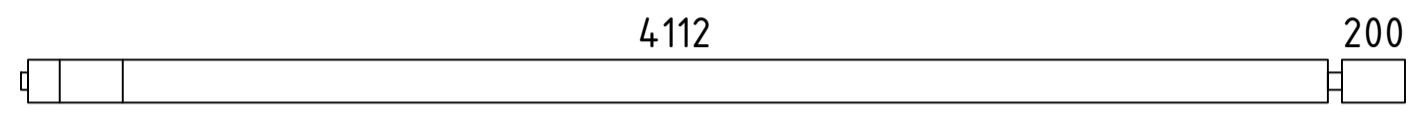
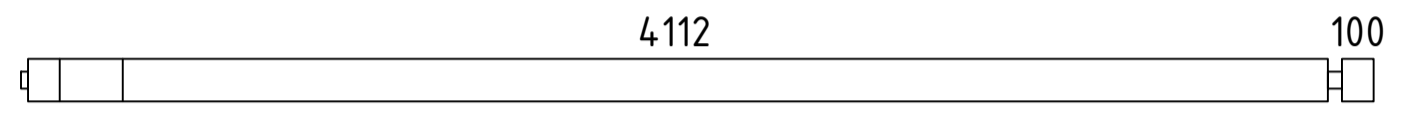
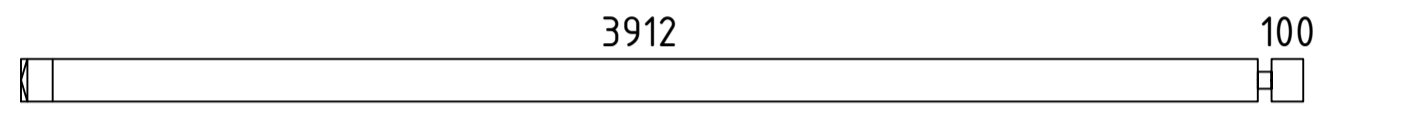
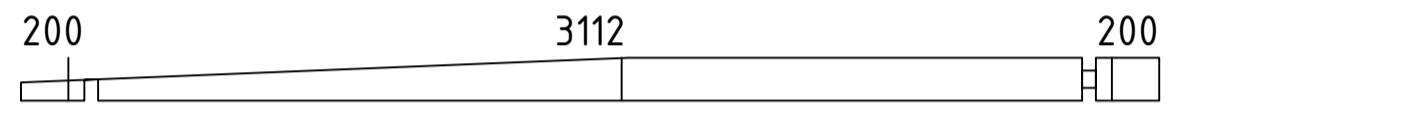
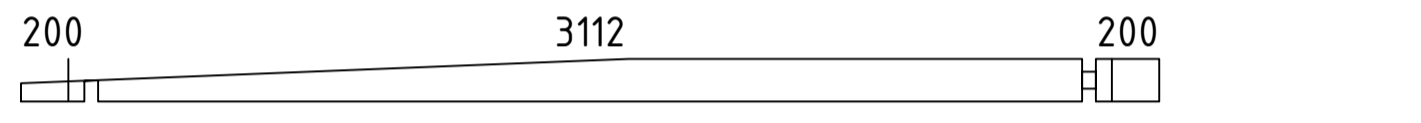
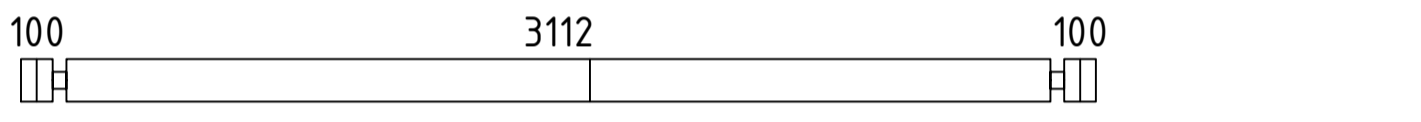
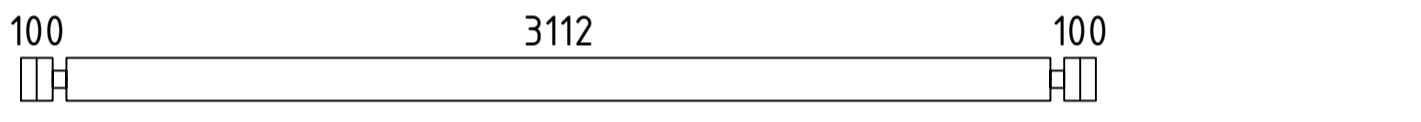
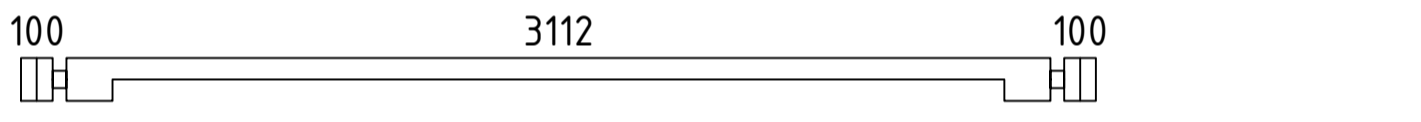
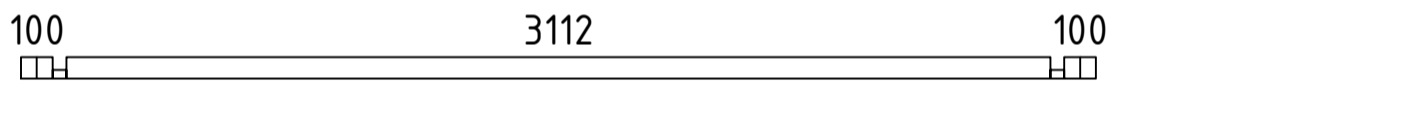
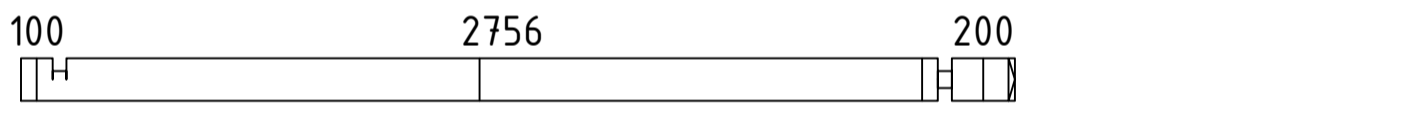
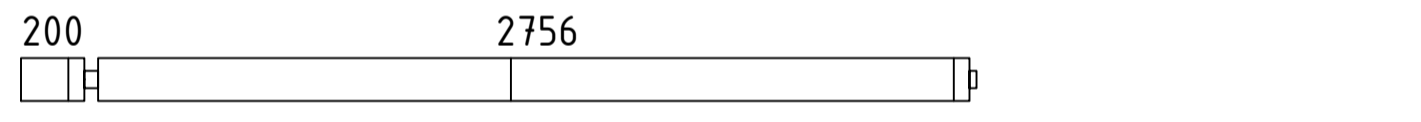
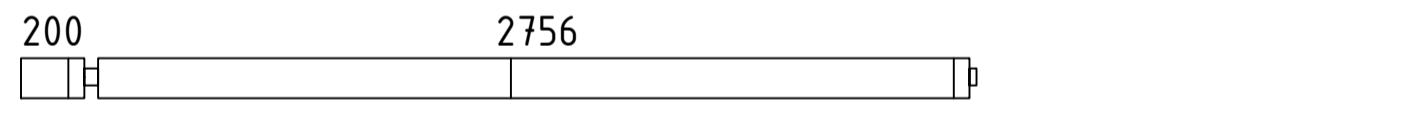
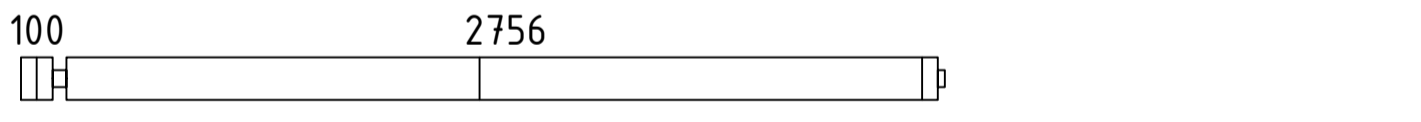

\* Fenster und Türen sind ohne Sprossen/  
Windows and doors are without muntins

Name	Jacob E 340x440+VD_44		
Zeichnung/Drawing	Grundplan Plan		
Blatt/Sheet	Profil/Profile	4.4x13.5	Datum/Date
			10.04.2019

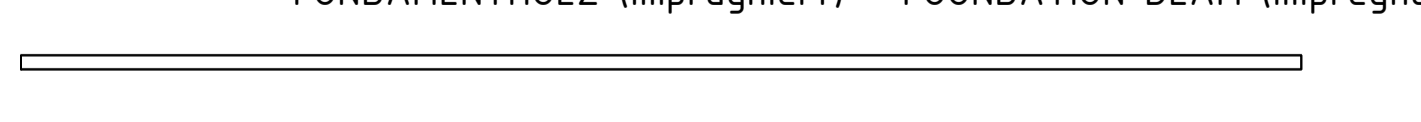
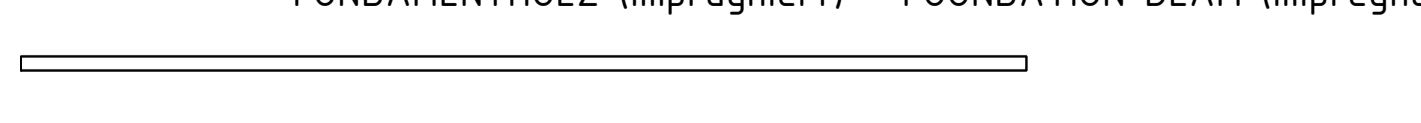

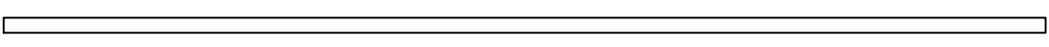
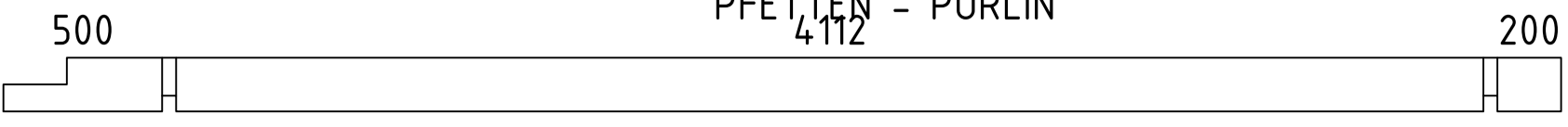
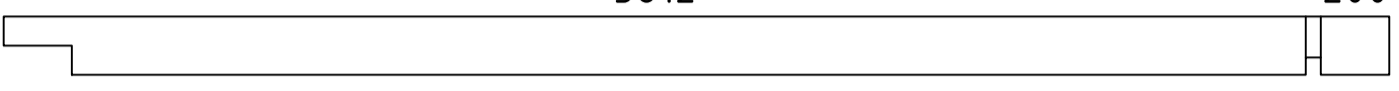
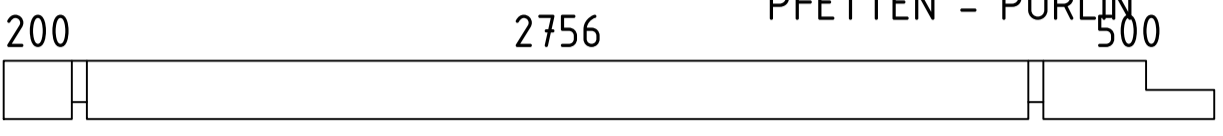
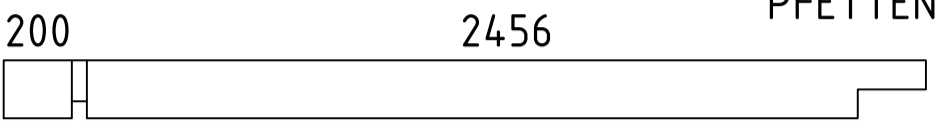
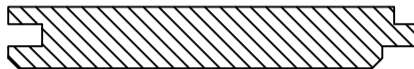
Name	Jacob E 340x440+VD_44		
Zeichnung/Drawing	Lagerholzplan Foundation beams		
Blatt/Sheet	Profil/Profile	4.4x13.5	Datum/Date
			10.04.2019

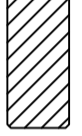
Pos	Teileliste/Specification Jacob E 340x440+VD_44	Stck. Pcs.	Profil Profile (mm)	Länge Length (mm)
001		1	44x135	4400
002		17	44x135	4400
003		1	44x135	4400
004		1	44x127	4378
005		1	44x135	4378
006		1	44x135	4278
007		2	44x135	4056
008		1	44x135	3600
009		2	44x135	3600
010		1	44x135	3400
011		17	44x135	3400
012		1	44x135	3400
013		1	44x68	3400
014		2	44x135	3144
015		1	44x135	3022
016		1	44x127	3022
017		1	44x135	2922
018		3	44x68	1678
019		21	44x135	639
020		1	44x135	639
021		22	44x135	496
022		2	44x68	290
023		28	44x135	290
FH1	FUNDAMENTHOLZ (imprägniert) - FOUNDATION BEAM (impregnated) 	2	65x44	4050
FH2	FUNDAMENTHOLZ (imprägniert) - FOUNDATION BEAM (impregnated) 	3	65x44	3180

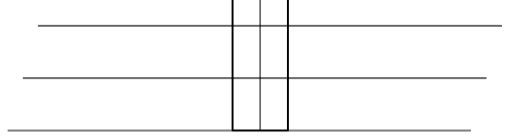
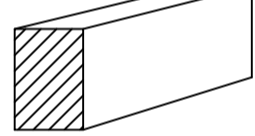
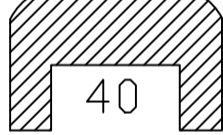
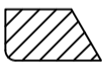
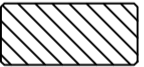
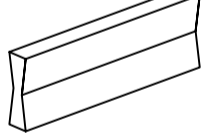
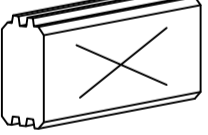
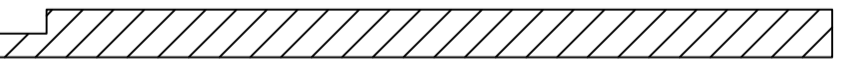
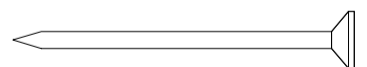
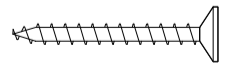
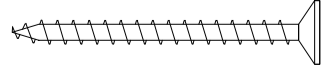
Pos	Teileliste/Specification Jacob E 340x440+VD_44		Stck Pcs.	Profil Profile (mm)	Länge Length (mm)
FH3	FUNDAMENTHOLZ (imprägniert) - FOUNDATION BEAM (impregnated) 		6	65x44	3050
PF2	500 PFETTEN - PURLIN 4112 200 		2	58x170	4900
PF4	3812 PFETTEN - PURLIN 200 		1	58x170	4056
PF3	200 2756 PFETTEN - PURLIN 500 		1	58x170	3544
PF1	200 2456 PFETTEN - PURLIN 		2	58x170	2700
	DACHBRETTEN - ROOF BOARDS		66+1	113x18	3505
	FUSSBODENBRETTEN - FLOOR BOARDS		28+1	113x18	4105
	FUSSBODENLEISTE - FLOOR STRIPS		✓	18x40	15.0 lfm/rm
BL-1	DACHBLENDEN - PARAPET 350mm 350 		2	18x350	3600
BL-2	DACHBLENDEN - PARAPET 350mm 350 		4	18x350	3718
VL-1	DACHBLENDEN- Verbindungsleisten - PARAPET- connecting strips 350mm 		2	120x18	350
BS-1	DACHBLENDEN- Blendenstützen - PARAPET- Parapet support 44x65 		12	44x65	200
UPB-1	DACHBLENDEN- U-Profil für Blenden - PARAPET- U-Profile 		✓	65x44	23.0 lfm/rm
DPL-1	DACHPAPPENLEISTE - ROOFING FELT STRIPS 15x28 		✓	15x28	15.0 lfm/rm
T4-1	TRAUFENLEISTE - EAVES STRIPS 40x18 		✓	40x18	15.0 lfm/rm
HK2	HOLZ-KLOTZEN für verbinden der Wandbohlen - Wooden wedge for connecting the wall parts (122mm) 		2		
SH	SCHLAGHÖLZER - MOUNTING PIECES 		3		
SP2-1	STÜTZPFOSTE - SUPPORT POST 90x90 		✓	90x90	2095
NG1	NÄGEL - NAILS 2.5x50 Dachbretter - Roof boards Fussbodenbretter - Floor boards 		1108		
SR01	SCHRAUBEN - SCREWS 3.0x30 Fussbodenleiste - Floor strips Traufenleiste - Eaves strips 40x18 Dachpappenleiste - Roofing felt Verbindungsleisten - Connecting strips 		107		
SR03	SCHRAUBEN - SCREWS 3.5x45 U-Profil für Blenden - Parapet U-Profile Verbindungsstreifen - Connecting strip Türleisten - Window/Door strips 		158		
Kood	Jacob E 340x440+VD_44	Materjal	File	Jacob E 340x440+VD_44.dwg	geht 2/4

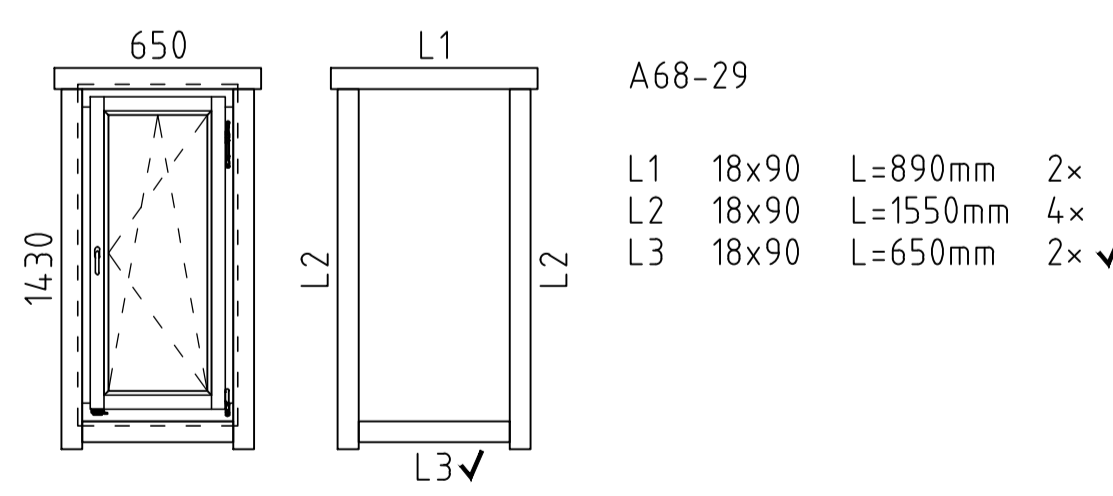
Pos	Teileliste/Specification Jacob E 340x440+VD_44	Stck. Pcs.	Profil Profile (mm)	Länge Length (mm)
SR11	SCHRAUBEN - SCREWS 5.0x100 Fundamenthölzer - Foundation beams	44		
SR10	SCHRAUBEN - SCREWS 5.0x70 Stützpfofte - Support post Dachblende - Parapet Blendenstützen - Parapet support	92		
VS	VERBINDUNGSSTREIFEN für verbinden der Wandbohlen - Connecting strip for connecting the wall parts	3		
VP2	Verstellbare Pfostenstütze - Adjustable post support M16	2		
ML1	Metallstange - Metal bar	3	D10	490
ML2	Metallstange - Metal bar	3	D10	360
KL-1	Gewindestange - Threaded Rod M12 PFETTEN - PURLIN	6		170
	Mutter - nut M12 U-Scheibe - washer Ø30 PFETTEN - PURLIN	12		
KL1	Gewindestange - Threaded Rod M8	4		2000
KL2	Gewindestange - Threaded Rod M8	2		460
KL3	Gewindestange - Threaded Rod M8	2		397
KL4	Gewindestange - Threaded Rod M8	2		393
KL5	Gewindestange - Threaded Rod M8	1		338
KL6	Gewindestange - Threaded Rod M8	4		270
	Mutter - nut M8 U-Scheibe - washer Ø25	22		
	Befestigungsmutter - fixing nut M8	4		
A68- 29 44	FENSTER/WINDOW 650x1430  	3		
Kood	Jacob E 340x440+VD_44	Materjal	File	Jacob E 340x440+VD_44.dwg geht 3/4



Akna tüüp / Fenster typ / Window type - A68  
(GH+ / SH)

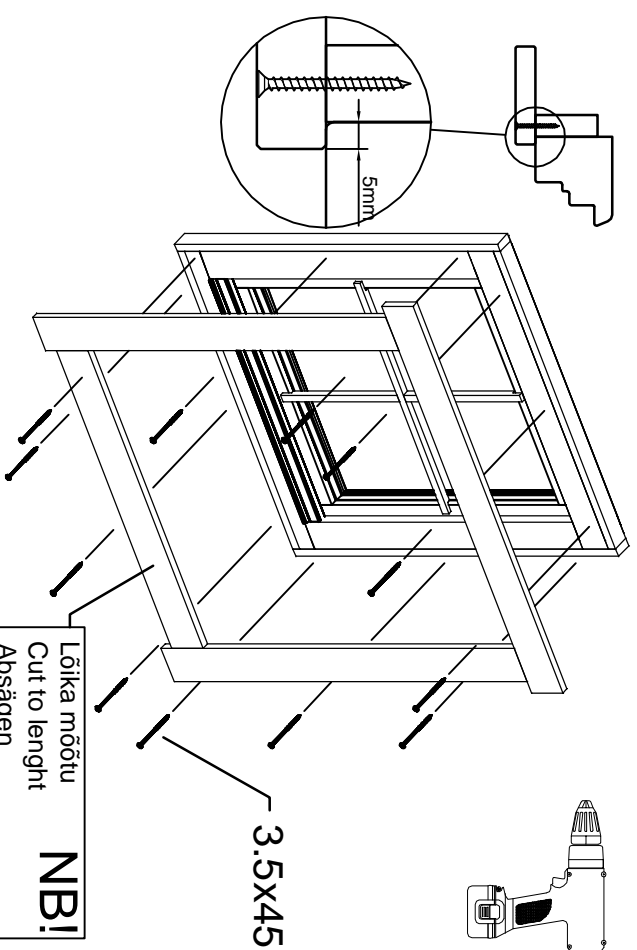
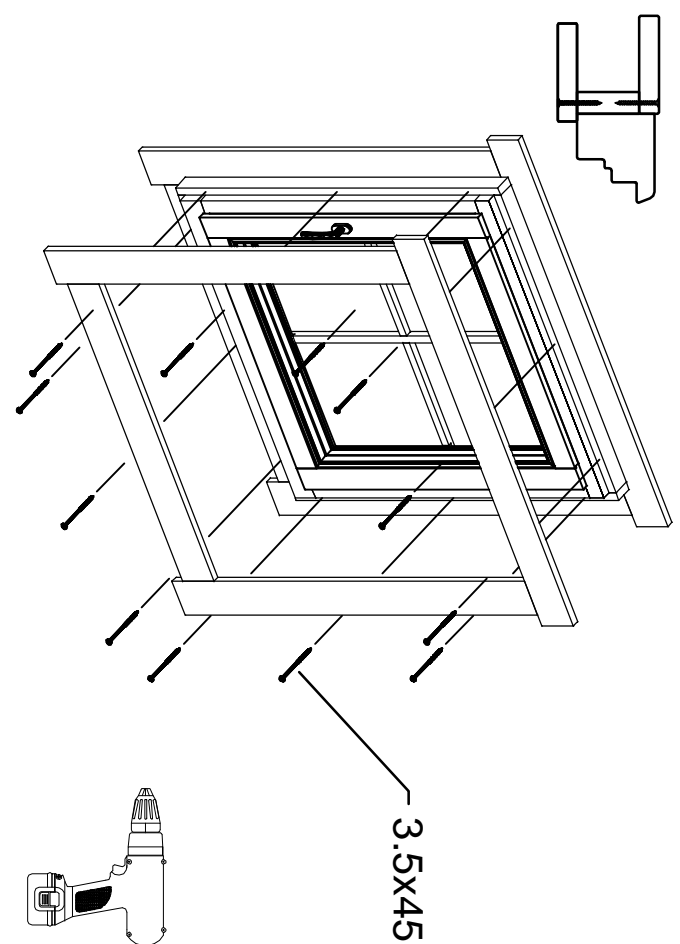
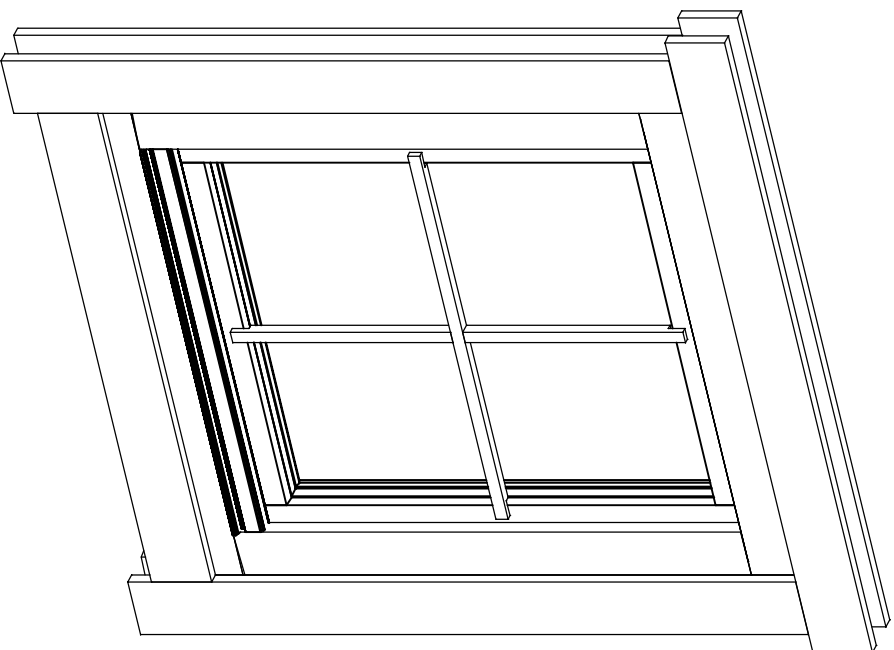



Ø4  
3mm  
13mm  
2x

1

Special Profile

4x30  
Screws

3

Special Profile

4.5x90  
Screws

Threshold  
90x28

4x30  
Screws

2

3,5x20

4

Door trims  
(90x18)  
3,5x45 Screws

Extra  
Floor joist

5

Covering salt (90x18)  
3,5x45 Screws

Guides

8

3,5x20

6

Covers (18x52x110)  
3,5x45 Screws

7

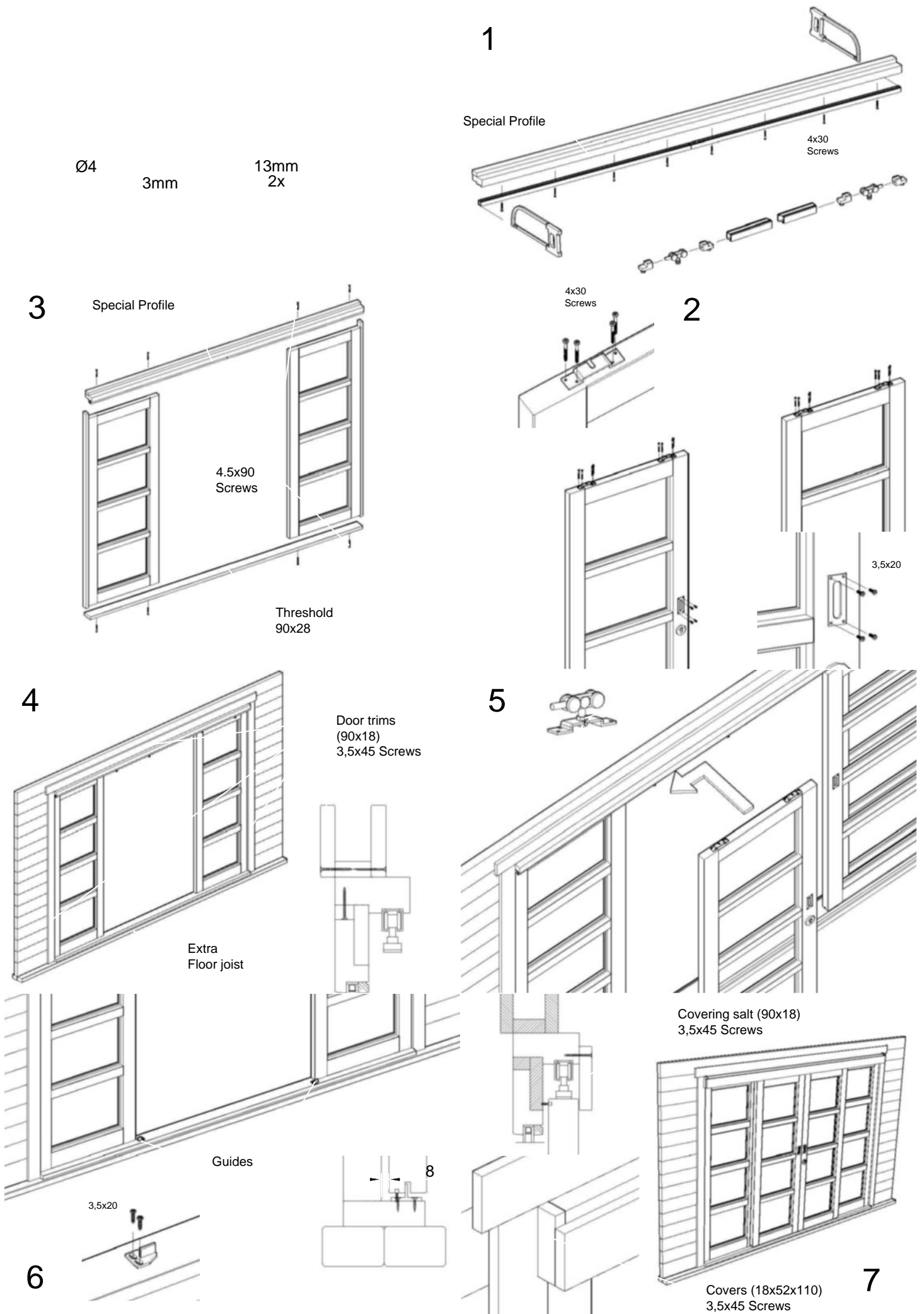

Ø4      3mm      13mm  
2x

1

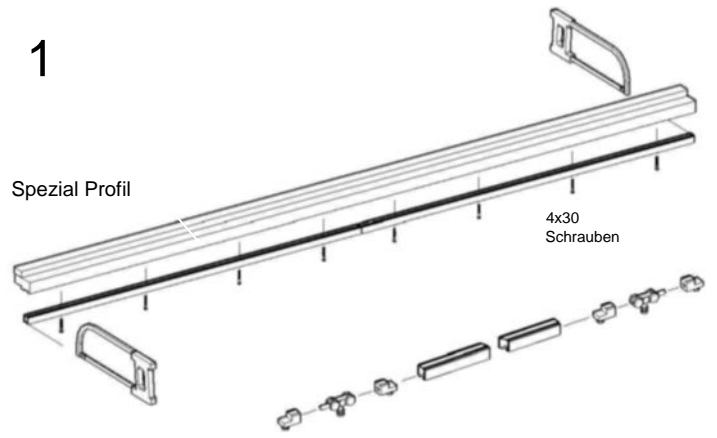

3

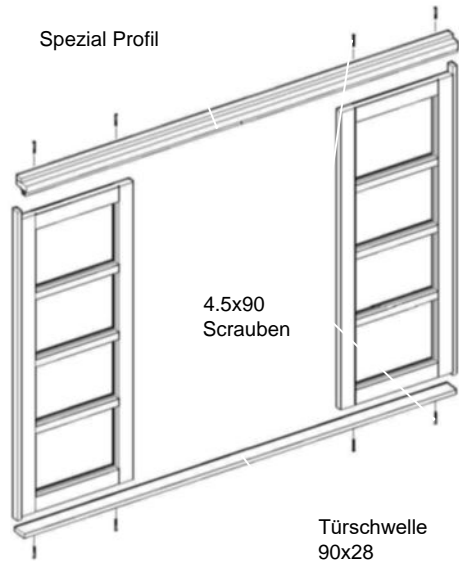

2

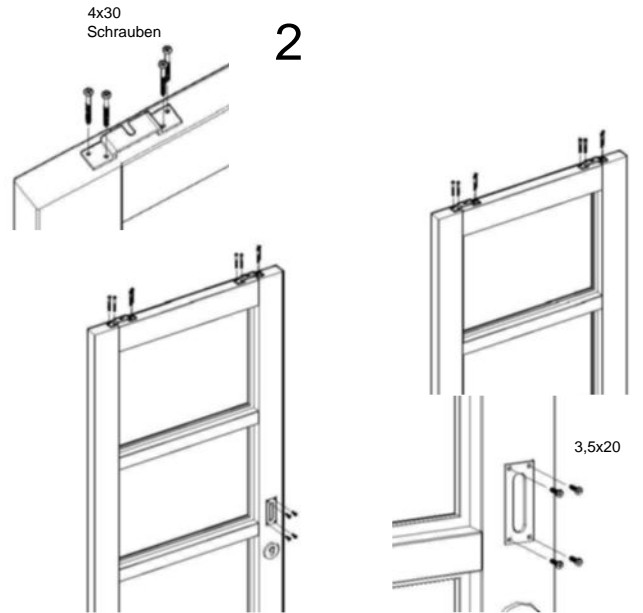

4

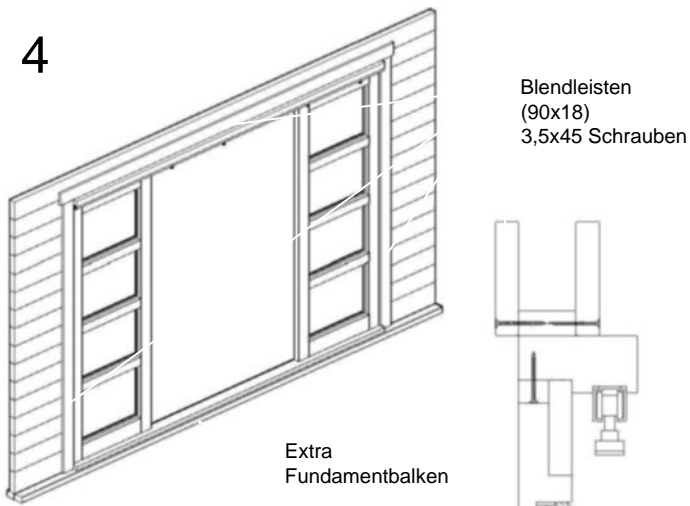

5

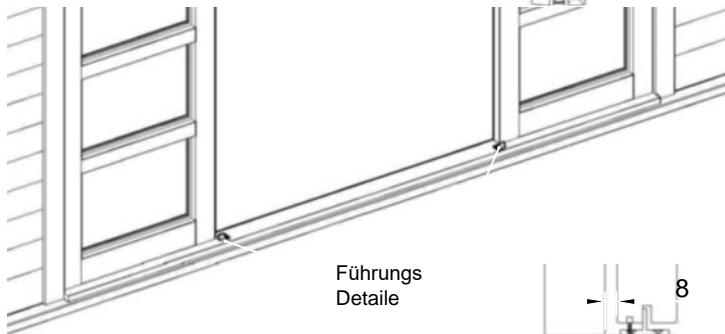
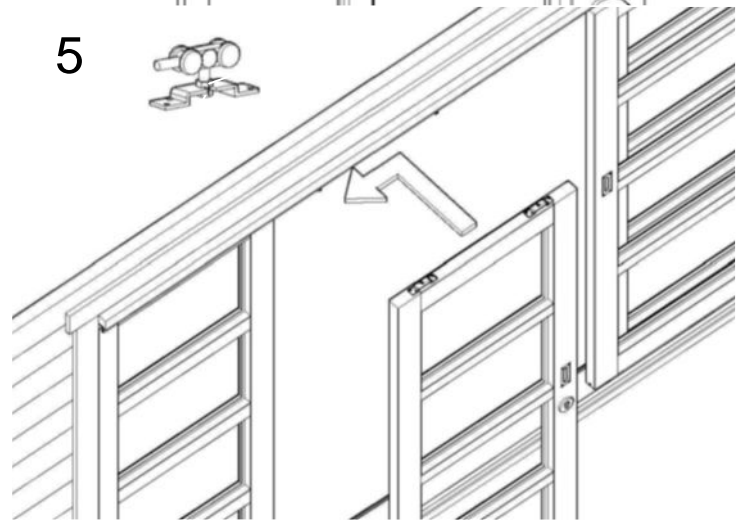

6

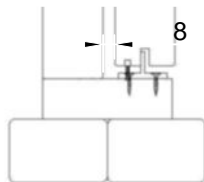
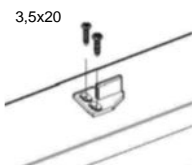

Deckbrett (90x18)  
3,5x45 Schrauben

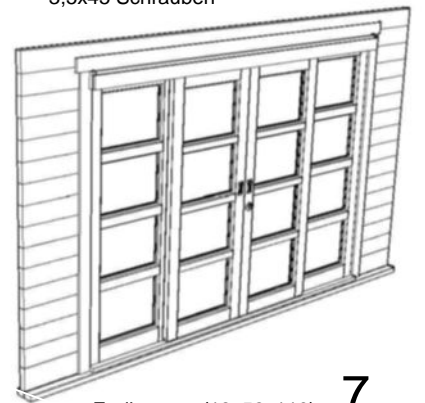

7

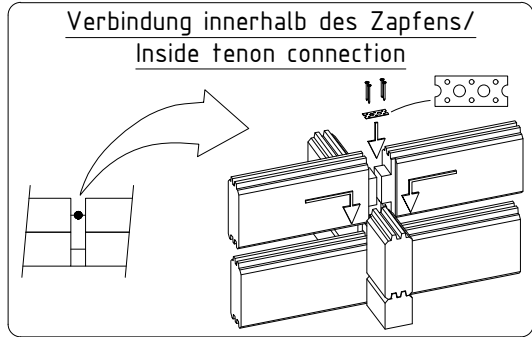
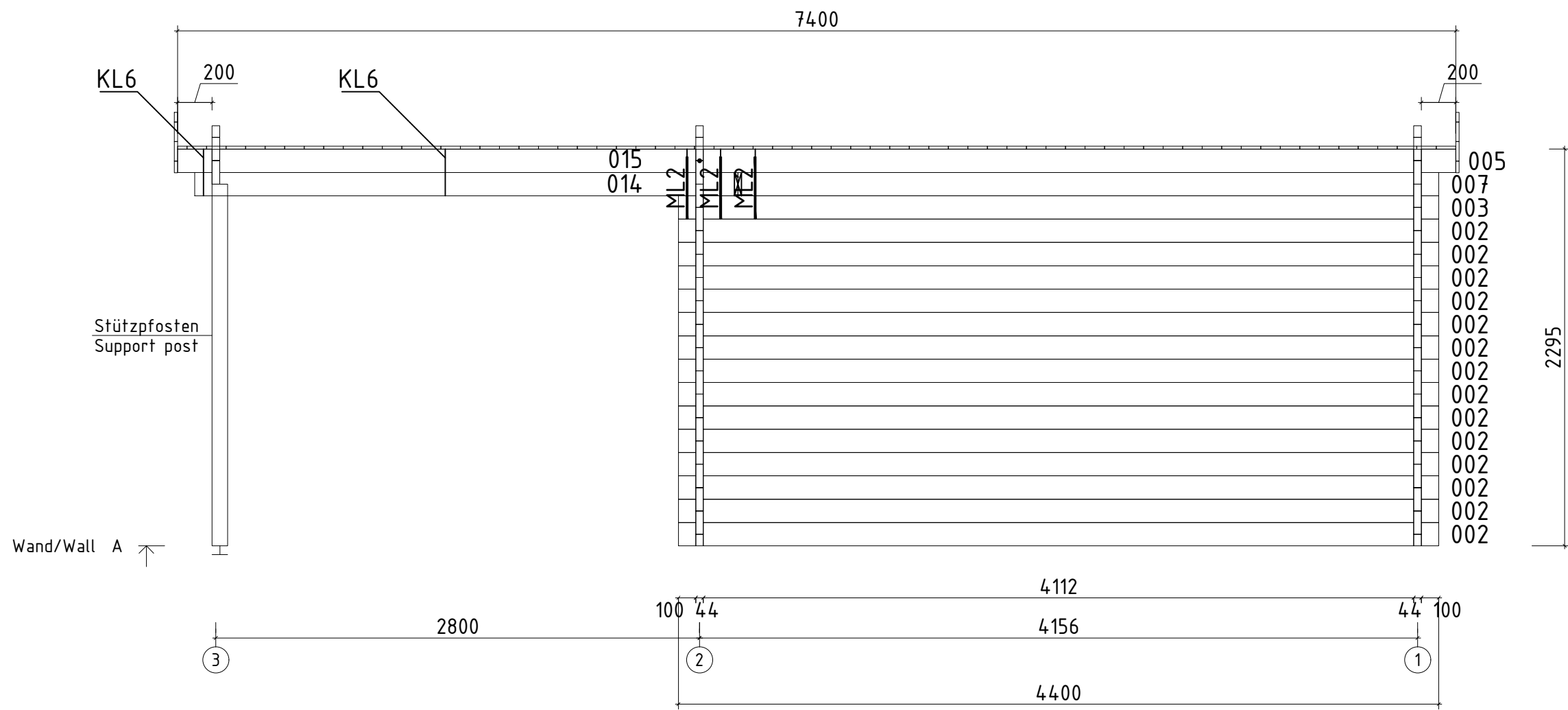

Name	Jacob E 340x440+VD_44		
Zeichnung/Drawing	WAND/WALL A		
Blatt/Sheet	2	Profil/Profile	4.4x13.5
		Datum/Date	10.04.2019

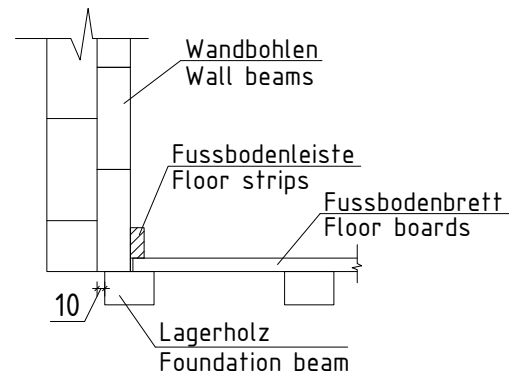
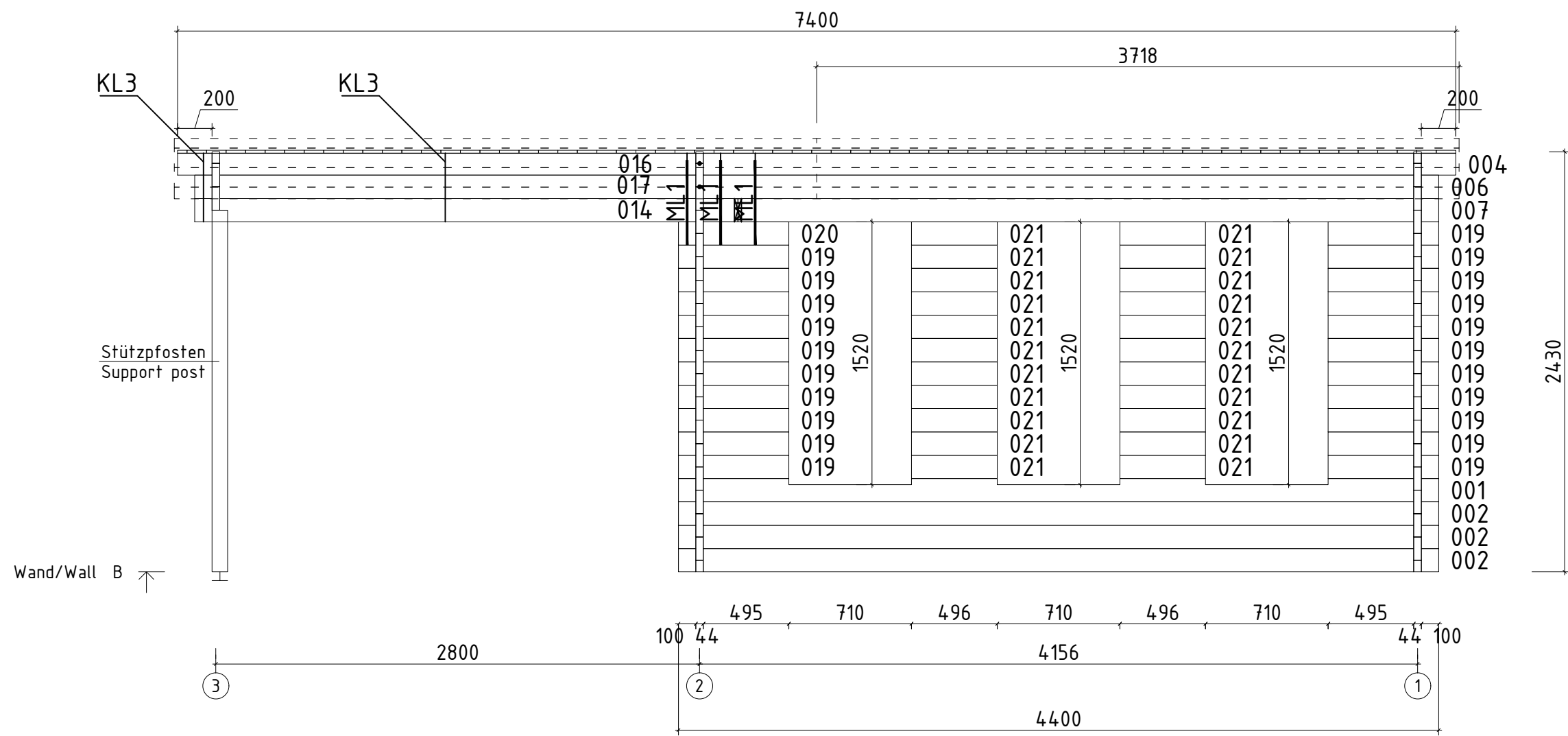

Name	Jacob E 340x440+VD_44		
Zeichnung/Drawing	WAND/WALL B		
Blatt/Sheet	3	Profil/Profile	4.4x13.5
		Datum/Date	10.04.2019

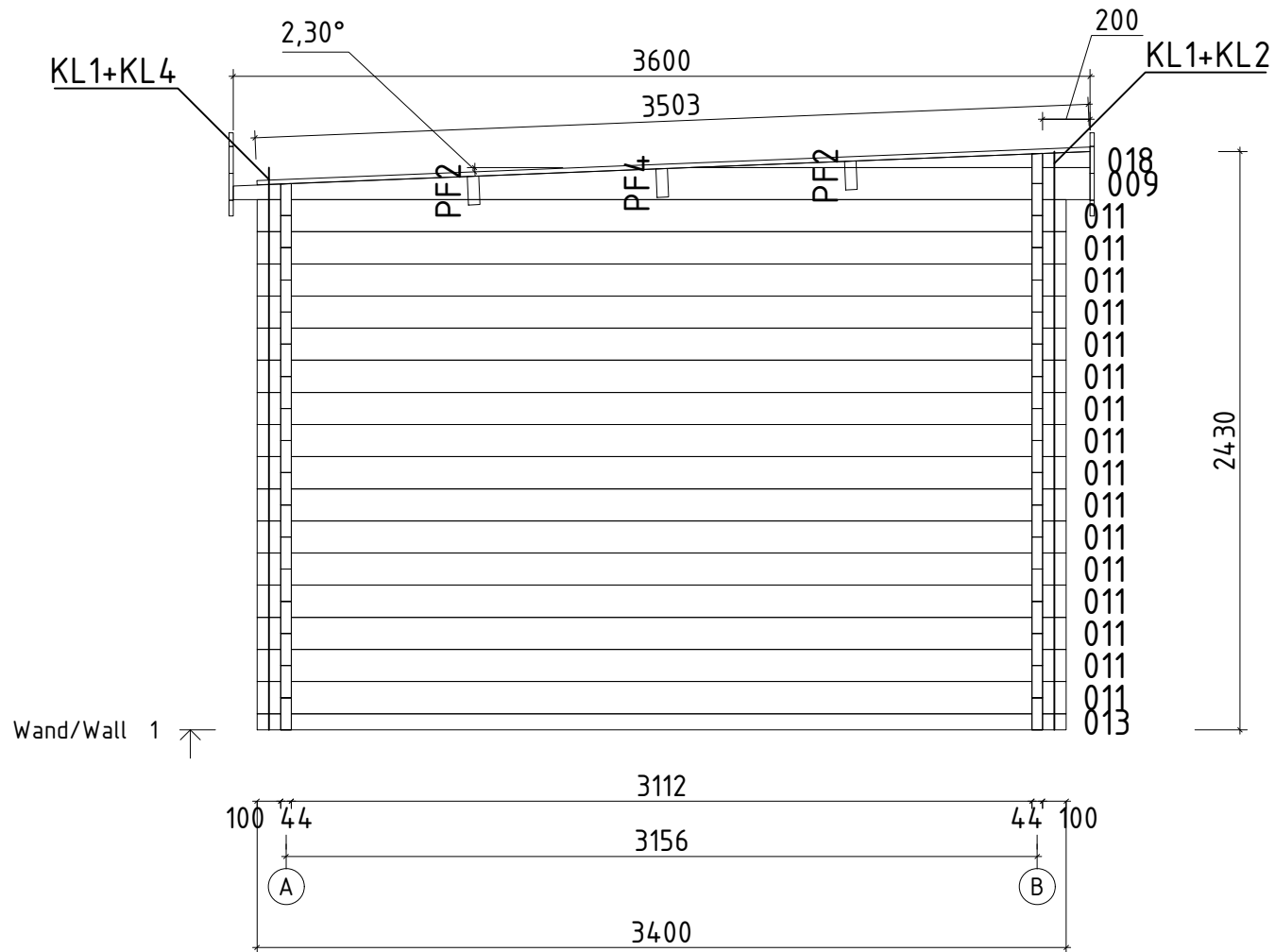

Name		Jacob E 340x440+VD_44	
Zeichnung/Drawing		WAND/WALL 1	
Blatt/Sheet	4	Profil/Profile	4.4x13.5
Datum/Date		10.04.2019	



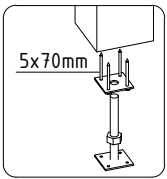
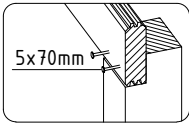
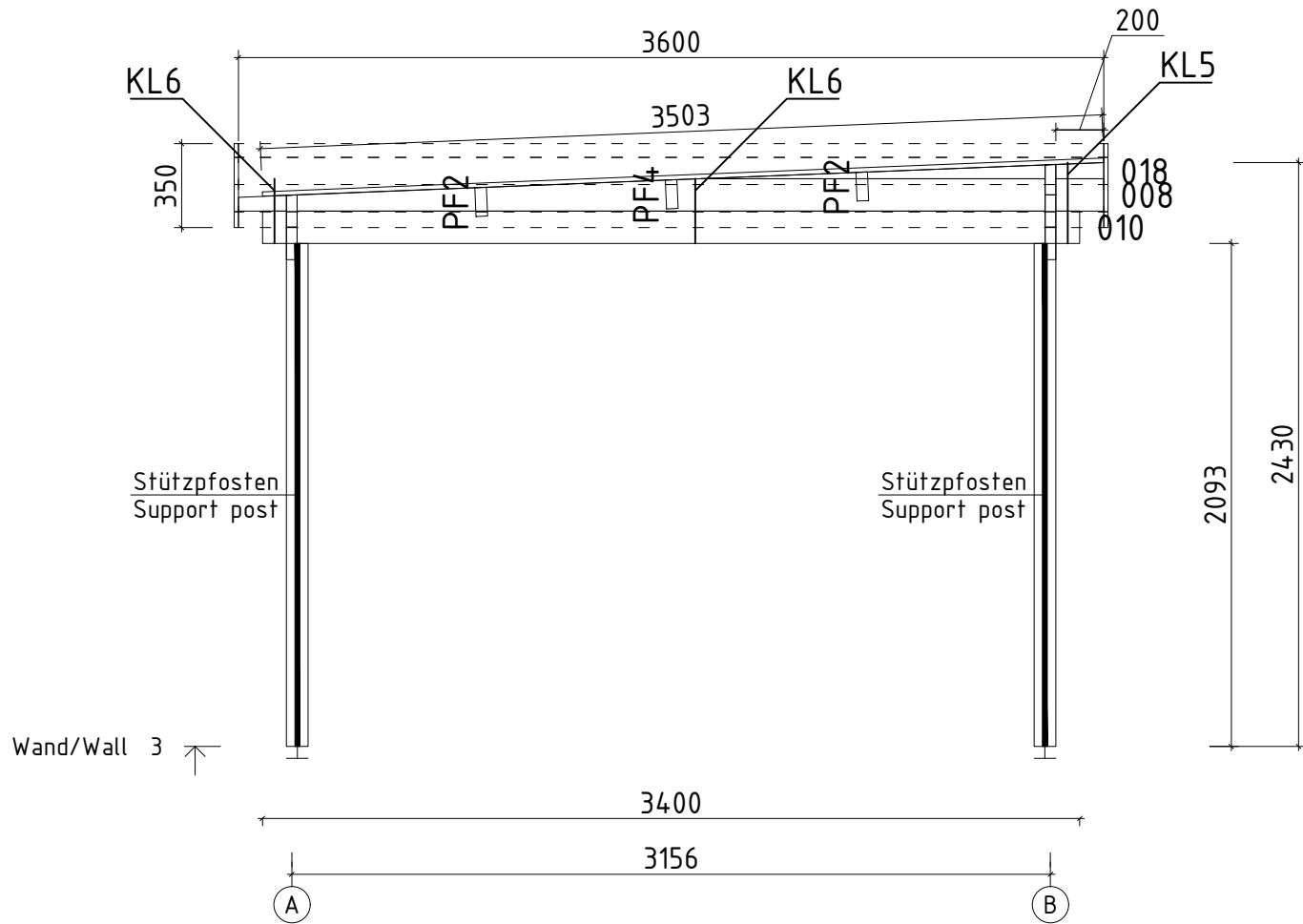

Parapet

Parapet

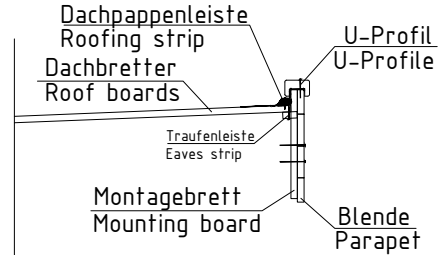
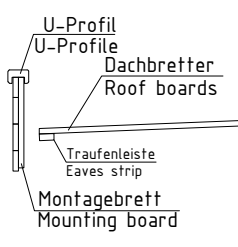

Name		Jacob E 340x440+VD_44	
Zeichnung/Drawing		WAND/WALL 3	
Blatt/Sheet	6	Profil/Profile	4.4x13.5
		Datum/Date	10.04.2019