

Das Haus Lucas D lässt sich auch spiegeverkehrt aufbauen.  
Cabin Lucas D can be built mirrored.

Name	Lucas D 320x320+VD+Terr_44		
Zeichnung/Drawing	3D		
Profil/Profile	4.4x13.5	Datum/Date	19.05.2021

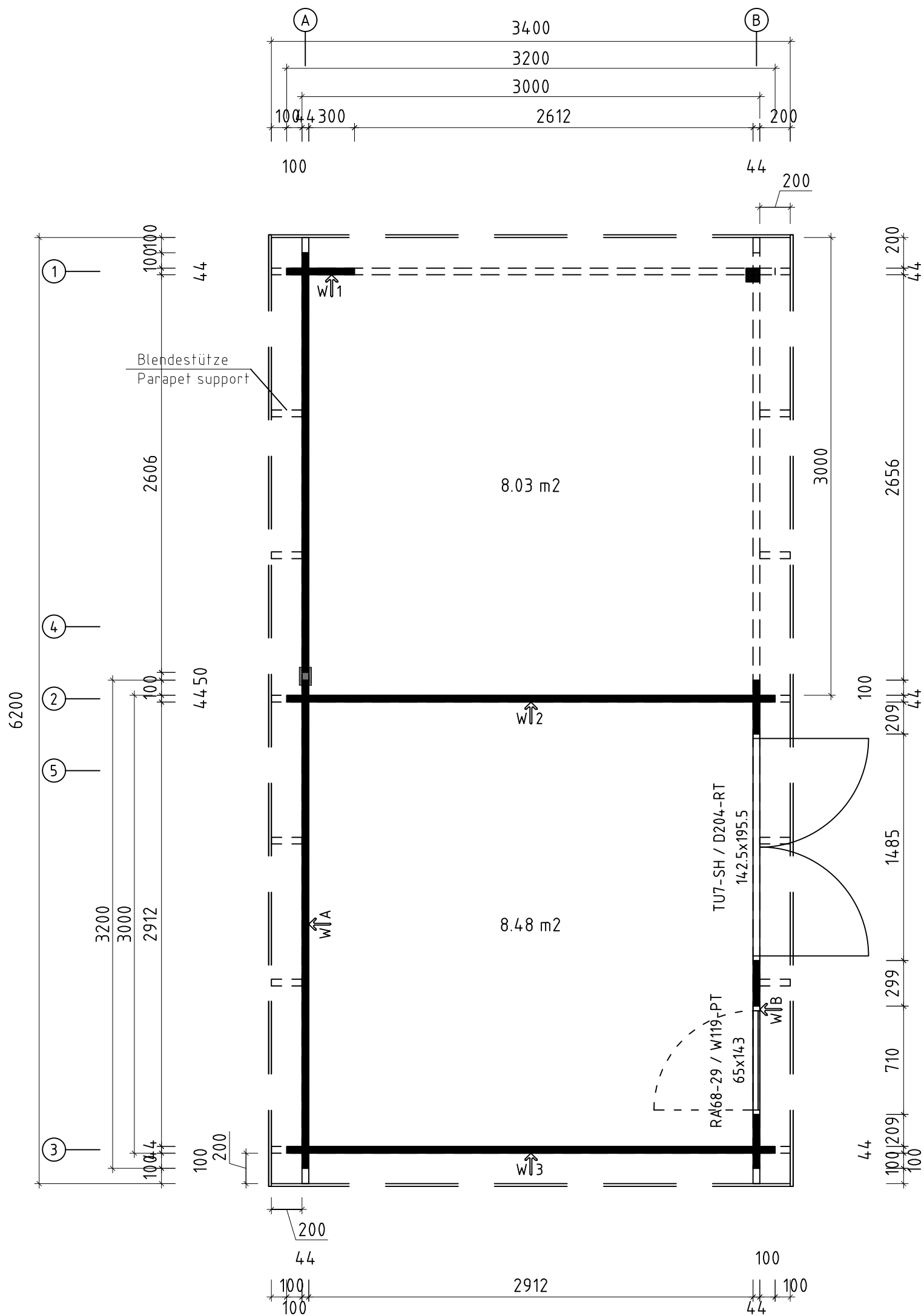





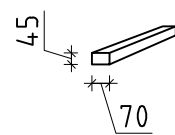
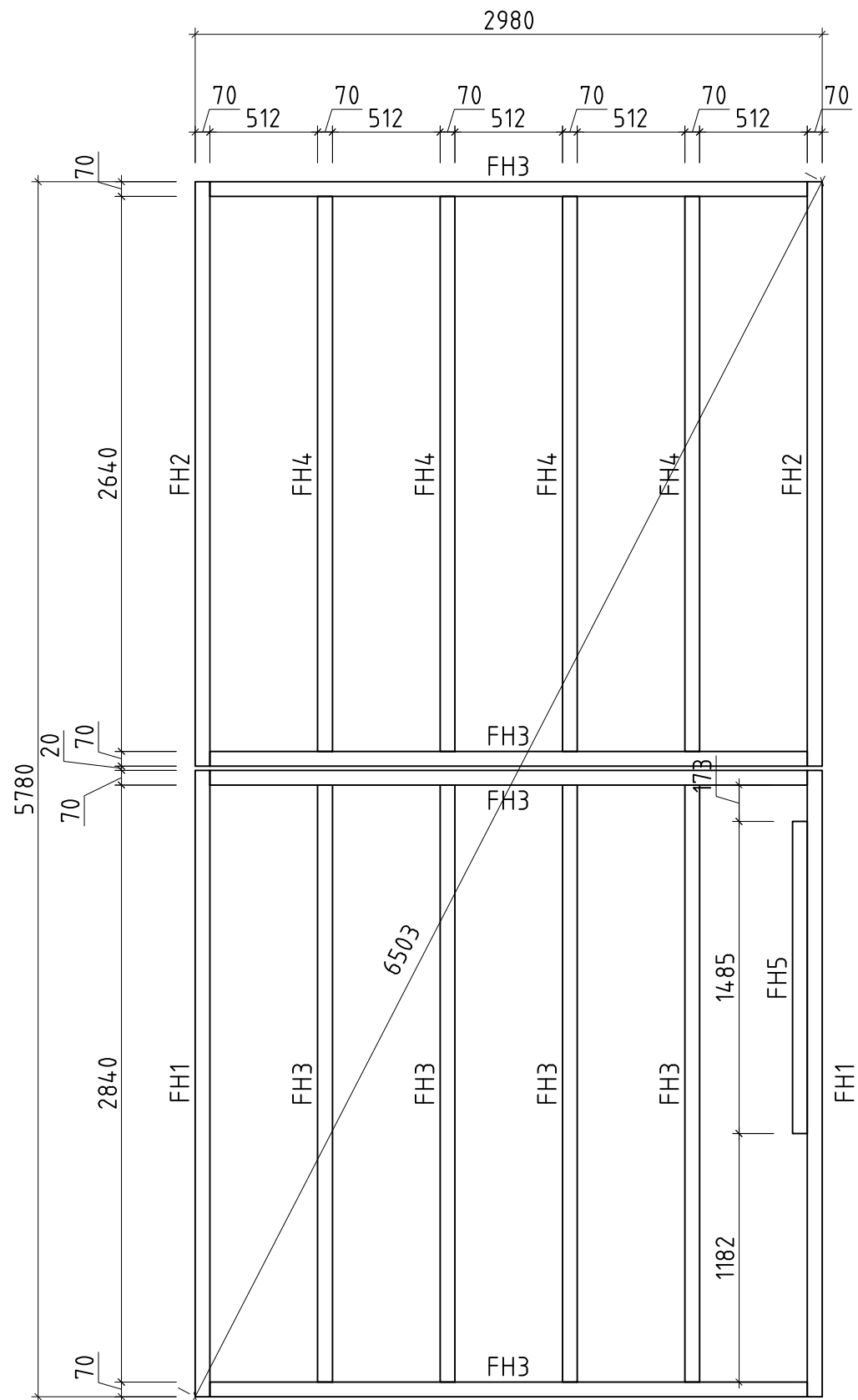

\* Fenster und Türen sind ohne Sprossen  
Windows and doors are without muntins



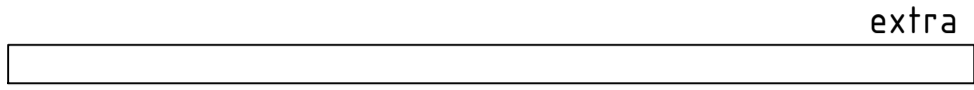
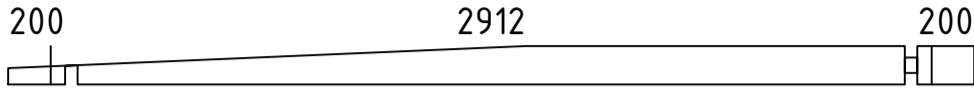
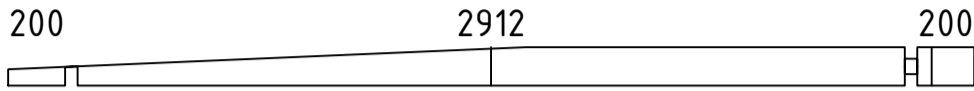
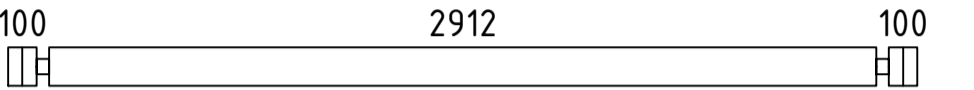
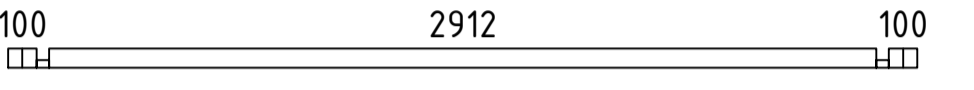
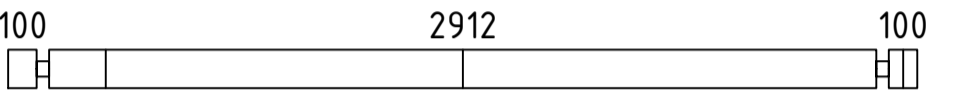
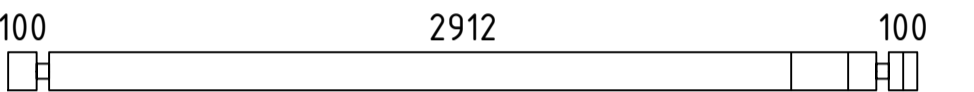
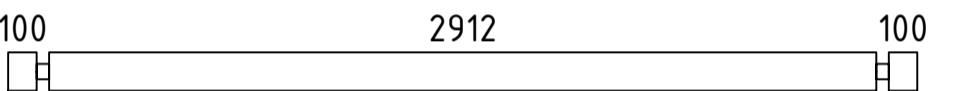
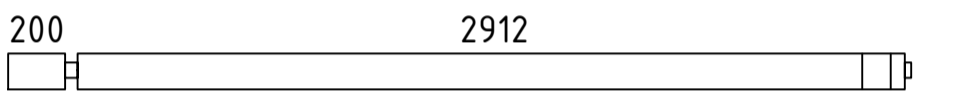
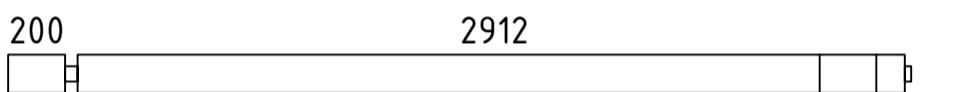
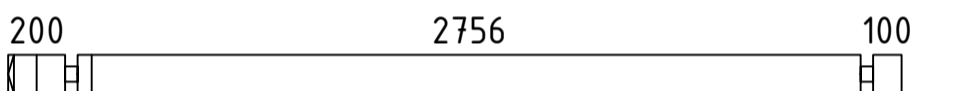
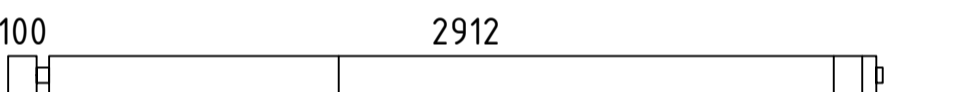
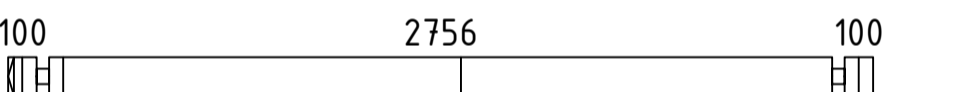
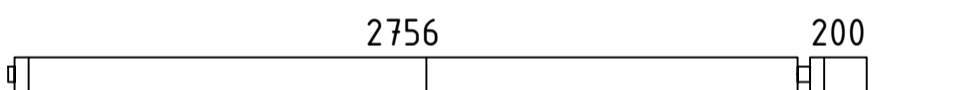
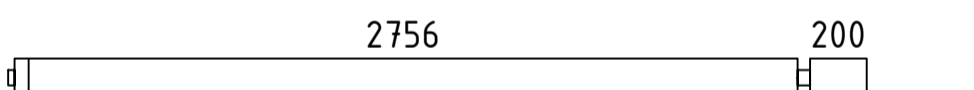
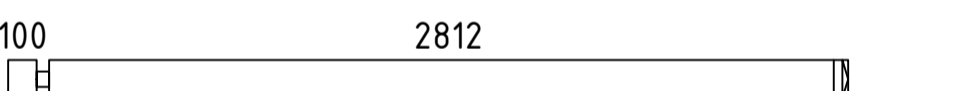
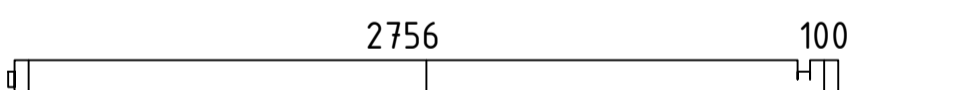
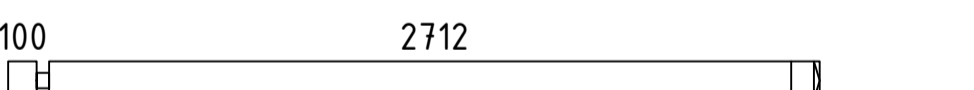
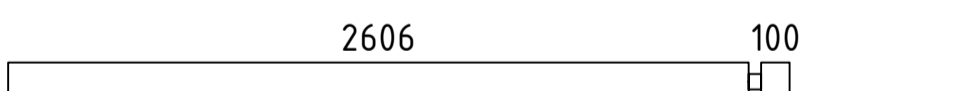
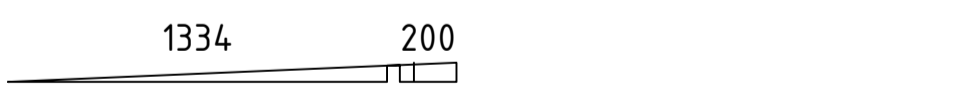







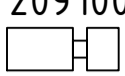
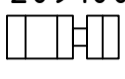
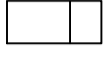
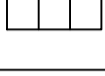
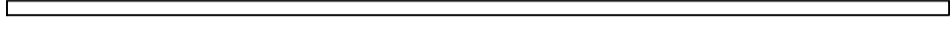
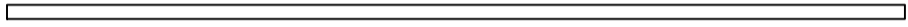
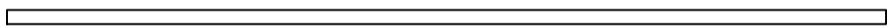

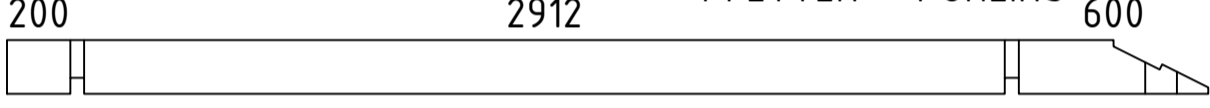
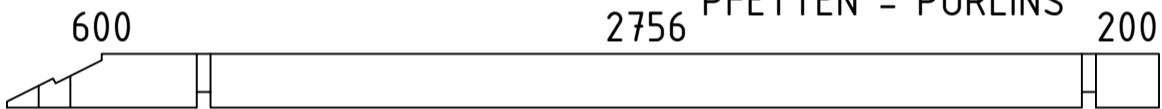
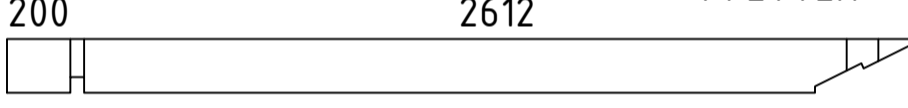
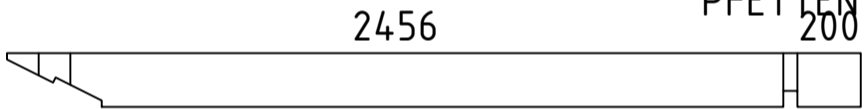
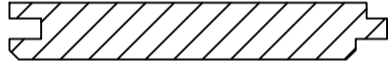
Q5 – Qualitätsklasse für Fenster und Türen/  
Quality class for windows and doors







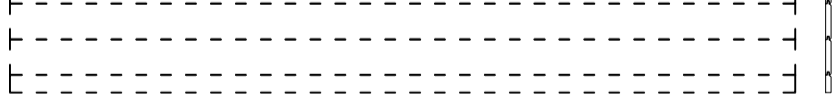

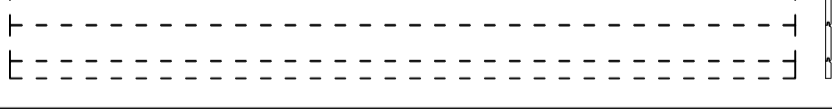
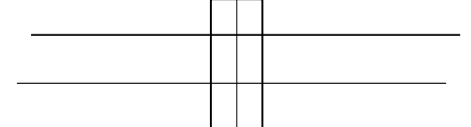
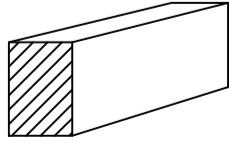
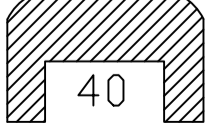
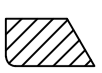
Name	Lucas D 320x320+VD+Terr_44		
Zeichnung/Drawing	Grundplan, Plan		
Profil/Profile	4.4x13.5	Datum/Date	19.05.2021

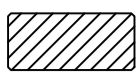
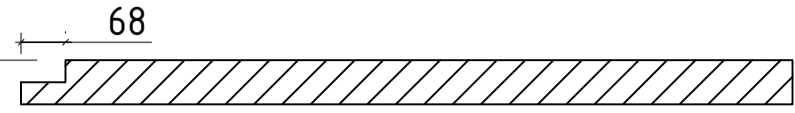
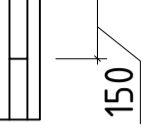
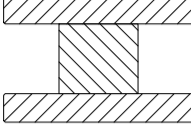
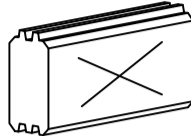
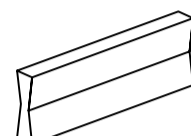
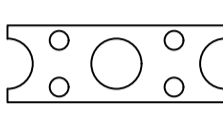
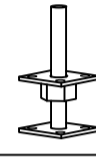
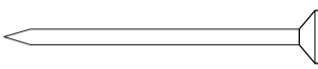
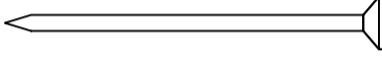
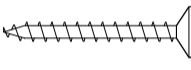
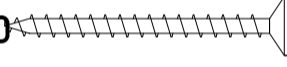
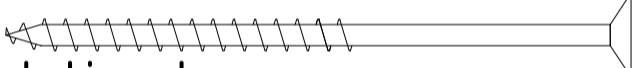



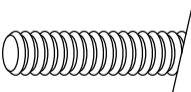
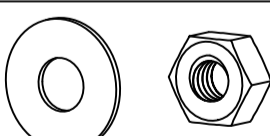
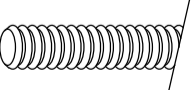
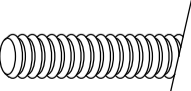
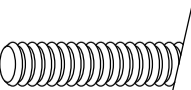

Name	Lucas D 320x320+VD+Terr_44		
Zeichnung/Drawing	Lagerholzplan, Foundation beams		
Profil/Profile	4.4x13.5	Datum/Date	19.05.2021

Pos	Teileliste Lucas D 320x320+VD+Terr_44	Stck.	Profil (mm)	Länge (mm)
	Achtung! Die Giebelbohlen können teilweise schon vormontiert sein! Bitte beachten - diese erscheinen nicht ganz so wie in der Teileliste beschrieben.			
	Notice! The gable pieces can be partly pre-assembled! Please notice - those differ from the description given in the specification list.			
000		1	44x135	3400
001		2	44x135	3400
002		1	44x135	3400
003		32	44x135	3200
004		2	44x68	3200
005		1	44x135	3200
006		1	44x135	3200
007		14	44x135	3200
008		1	44x126	3178
009		1	44x135	3178
010		1	44x135	3144
011		1	44x135	3078
012		1	44x135	3044
013		1	44x126	3022
014		1	44x135	3022
015		1	44x135	2956
016		1	44x135	2922
017		1	44x135	2856
018		15	44x135	2750
019		3	44x68	1578
020		1	44x135	1362
021		3	44x135	1362
022		8	44x135	444
023		4	44x135	444
024		3	44x135	444
025		1	44x68	444

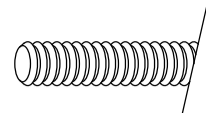
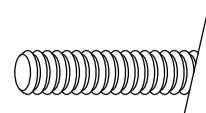
Pos	Teileliste Lucas D 320x320+VD+Terr_44		Stck.	Profil (mm)	Länge (mm)
026	209100 		25	44x135	353
027	209100 		1	44x135	353
028			9	44x135	299
029			2	44x135	299
FH1	FUNDAMENTHOLZ (imprägniert) - FOUNDATION BEAM (impregnated) 		2	70x45	2980
FH3	FUNDAMENTHOLZ (imprägniert) - FOUNDATION BEAM (impregnated) 		8	70x45	2840
FH2	FUNDAMENTHOLZ (imprägniert) - FOUNDATION BEAM (impregnated) 		2	70x45	2780
FH4	FUNDAMENTHOLZ (imprägniert) - FOUNDATION BEAM (impregnated) 		4	70x45	2640
FH5	FUNDAMENTHOLZ (imprägniert) - FOUNDATION BEAM (impregnated) 		1	70x45	1485
PF1	200 2912 PFETTEN - PURLINS 600 		1	58x170	3800
PF4	600 2756 PFETTEN - PURLINS 200 		1	58x170	3644
PF3	200 2612 PFETTEN - PURLINS 		1	58x170	2856
PF2	2456 PFETTEN - PURLINS 200 		1	58x170	2700
	DACHBRETTEN - ROOF BOARDS 		55+1	113x18	3305
	FUSSBODENBRETTEN - FLOOR BOARDS 		26+1	113x28	2905
	TERRASSENBRETTEN (imprägniert) - TERRACE BOARDS (impregnated) 		23+1	120x28	2950
	DECKENLEISTEN - CEILING STRIPS  ✓			15x28	21.0lfm
	FUSSBODENLEISTEN - FLOOR STRIPS  ✓			14x55	12.0lfm
BL-3	DACHBLENDEN - PARAPET 336mm 		2	18x336	4000
BL-1	DACHBLENDEN - PARAPET 336mm 		2	18x336	2236
BL-2	DACHBLENDEN - PARAPET 336mm 		2	18x336	3400
VL-1	DACHBLENDEN- Verbindungsleisten - PARAPET- connecting strips 		2	18x120	336
BS-1	DACHBLENDEN- Blendenstützen - PARAPET- Parapet support 44x65 		8	44x65	200
UPB-1	DACHBLENDEN- U-Profil für Blenden - PARAPET- U-Profile  40 ✓			65x44	20.0 lfm/rm
DPL-1	DACHPAPPENLEISTEN - ROOFING FELT STRIPS 15x28  ✓			15x28	13.0 lfm/rm
Kood	Lucas D 320x320+VD+Terr_44	Material	File	Leht	2/4

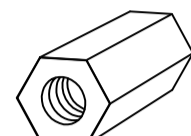
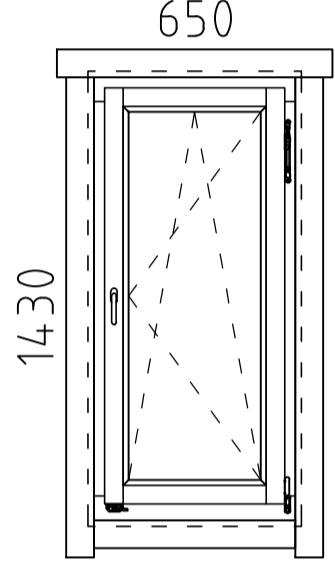
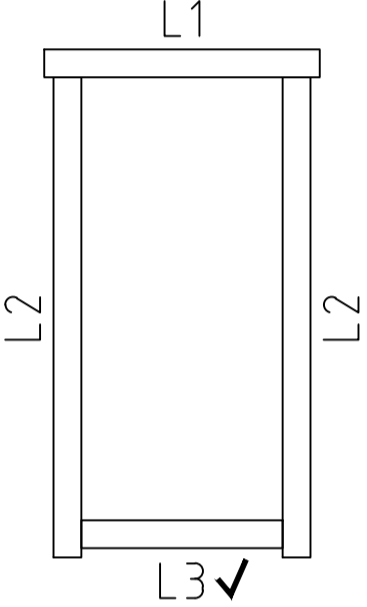
Pos	Teileliste Lucas D 320x320+VD+Terr_44		Stck.	Profil (mm)	Länge (mm)
T06-1	TRAUFENLEISTEN - EAVES STRIPS 18x40		✓	18x40	13.0 lfm/rm
TP90 -1	STÜTZPFOSTE - SUPPORT POST 90x90		✓	120x120	2025
A44-1	ADAPTER 44 Obere seite Upper side			1	80x120 2125
SH	SCHLAGHÖLZER - MOUNTING PIECES		3		
HK2	HOLZ-KLOTZEN für verbinden der Wandbohlen - Wooden wedge for connecting the wall parts (122mm)		2		
VS	Verbindungsstreifen für verbinden der Wandbohlen - Connecting strip for connecting the wall parts		3		
VP2	Verstellbare Pfostenstütze - Adjustable post support M16		1		
NG04	NÄGEL - NAILS 2.5x50 Dachbretter - Roof boards		440		
NG05	NÄGEL - NAILS 2.5x60 Fussbodenbretter - Floor boards Terrassenbretter - Terrace boards		588		
SR32	Schrauben - Screws 3.0x30 Deckenleisten - Ceiling strips Fussbodenleiste - Floor strips Traufenleiste - Eaves strips 40x18 Dachpappenleiste - Roofing felt Verbindungsleisten - Connecting strips		125		
SR37	Schrauben - Screws 3.5x45 U-Profil für Blenden - Parapet U-Profile Verbindungsstreifen - Connecting strip Türleisten - Window/Door strips		108		
SR57	Schrauben - Screws 5.0x100 Fundamenthölzer - Foundation beams		68		
SR55	Schrauben - Screws 5.0x70 Verstellbare pfosten... - Adjustable post support Blendenbefestigung - Parapet mounting		80		
ML1	Metallstange - Metal bar		1	D10	1040
ML2	Metallstange - Metal bar		3	D10	900
ML3	Metallstange - Metal bar		1	D10	830
ML4	Metallstange - Metal bar		3	D10	490
ML5	Metallstange - Metal bar		3	D10	360
KL-1	Gewindestange - Threaded rod M12- für die Pfetten - for purlins		4		170
MUT26	Mutter - Nut M12 U-Scheibe - Washer Ø30- für die Pfetten - for purlins		8		
KL1	Gewindestange - Threaded Rod M8		4		2000
KL2	Gewindestange - Threaded Rod M8		2		460
KL3	Gewindestange - Threaded Rod M8		2		396
KL4	Gewindestange - Threaded Rod M8		2		393
Kood	Lucas D 320x320+VD+Terr_44	Material	File	Leht	3/4

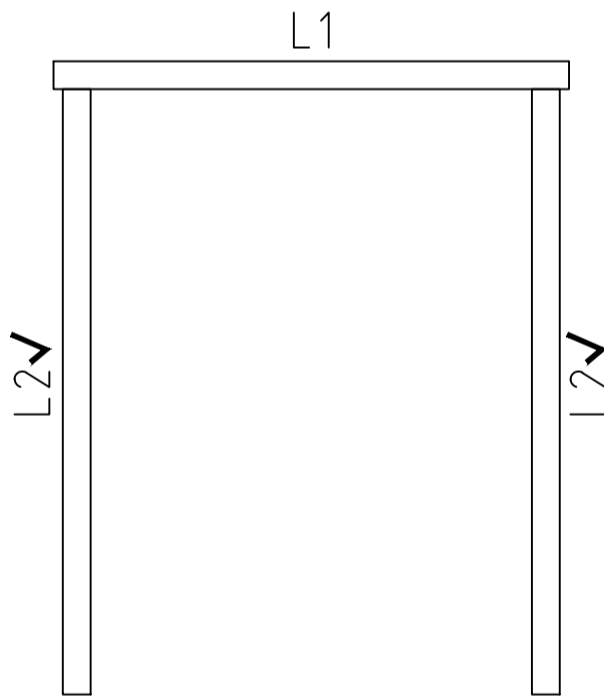
Pos	Teileliste Lucas D 320x320+VD+Terr_44	Stck.	Profil (mm)	Länge (mm)												
KL5	Gewindestange - Threaded Rod M8 	1		338												
KL6	Gewindestange - Threaded Rod M8 	1		270												
KV M UT M8	Mutter - Nut M8 	16														
KV S EIB M8X25	U-Scheibe - Washer M8 Ø25 	16														
KV MU TJ M8	Befestigungsmutter - Fixing nut M8 	4														
	<b>FENSTER Q5</b> <span style="float: right;">W5-S44P-0XT-06501430</span>	1														
<div style="display: flex; align-items: center;"> <div style="margin-right: 20px;">  </div> <div style="margin-right: 20px;">  </div> <div> <p>RA68-29 / W119-PT</p> <table border="0"> <tr><td>L1</td><td>18x90</td><td>L=890mm</td><td>2x</td></tr> <tr><td>L2</td><td>18x90</td><td>L=1550mm</td><td>4x</td></tr> <tr><td>L3</td><td>18x90</td><td>L=650mm</td><td>2x ✓</td></tr> </table> </div> </div>					L1	18x90	L=890mm	2x	L2	18x90	L=1550mm	4x	L3	18x90	L=650mm	2x ✓
L1	18x90	L=890mm	2x													
L2	18x90	L=1550mm	4x													
L3	18x90	L=650mm	2x ✓													
	<b>TÜR Q5</b> <span style="float: right;">D5-D44R-7XT-14251955</span>	1														
<div style="display: flex; align-items: center;"> <div style="margin-right: 20px;">  </div> <div style="margin-right: 20px;">  </div> <div> <p>TU7-SH / D204-RT</p> <table border="0"> <tr><td>L1</td><td>18x90</td><td>L=1665mm</td><td>2x</td></tr> <tr><td>L2</td><td>18x90</td><td>L=1955mm</td><td>4x ✓</td></tr> </table> <p>DIN rechts / Right handed</p> </div> </div>					L1	18x90	L=1665mm	2x	L2	18x90	L=1955mm	4x ✓				
L1	18x90	L=1665mm	2x													
L2	18x90	L=1955mm	4x ✓													
<b>✓ - Bitte selber anpassen (falls nötig)! / Cut into length on site (if needed)!</b>																
Kood	Lucas D 320x320+VD+Terr_M4	File		Leht 4/4												

Aken	Q4-Q6	-	paigaldusjuhis
Window	Q4-Q6	-	assembly instructions
Fenster	Q4-Q6	-	Montageanleitung

5-10mm

3.5x45

Lõika mõõtu  
Cut to length  
Absägen  
- 10mm / -20mm

**NB!**

3.5x45



Vihmaliist / Rain strip / Wasserleiste

Q5-Q6

\*Silikoon

\*Silicon

\*Silikon

\*Vajumispilu

\*Settling gap

\*Senkungs spalt

ca 40-50mm

NB!

- Monteerida juhul kui ese on välja toodud maja spetsifikatsioonis!
- Install only if the item is listed in the house specification!
- Nur montieren wenn die Leiste in der Teileliste gezeigt ist!

Veeplekk / Window sill / Fensterbank

4,2x16

Ukse montaa 0 / Tür montage / Door assembly  
(GH+ / SH)

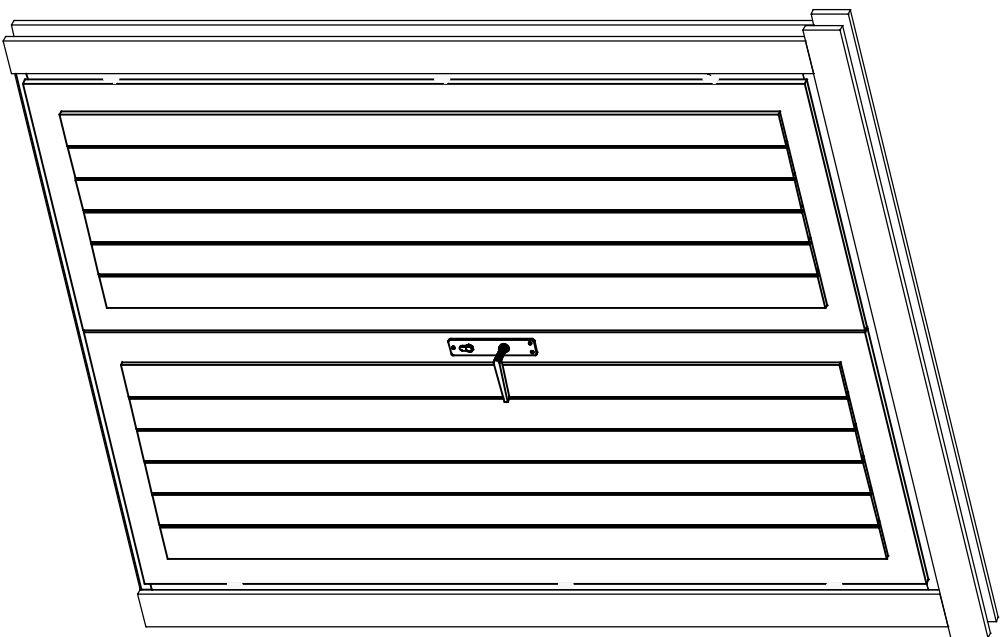

4.5x90

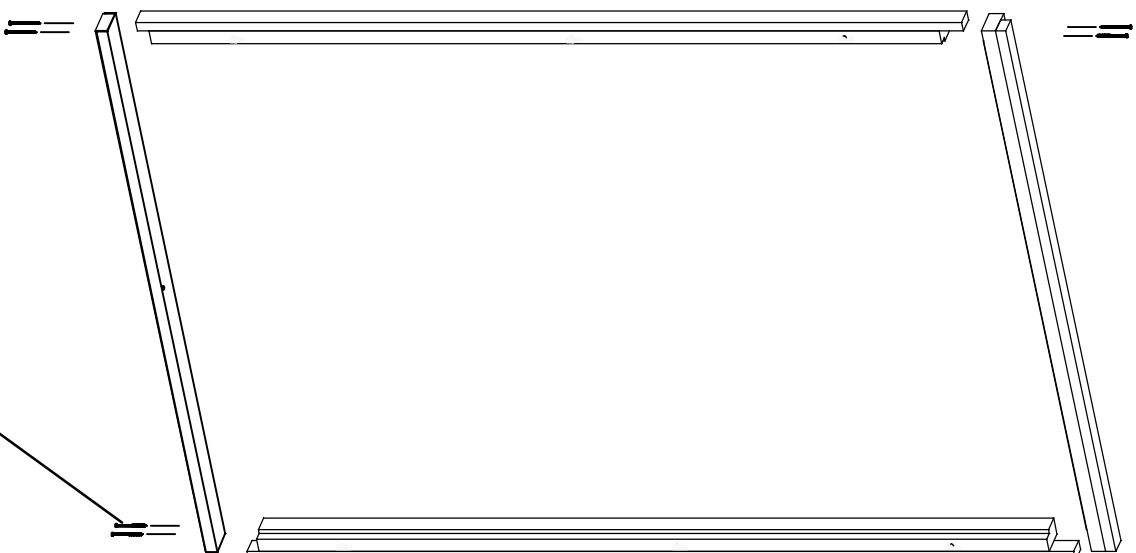

4.5x90



3.5x45

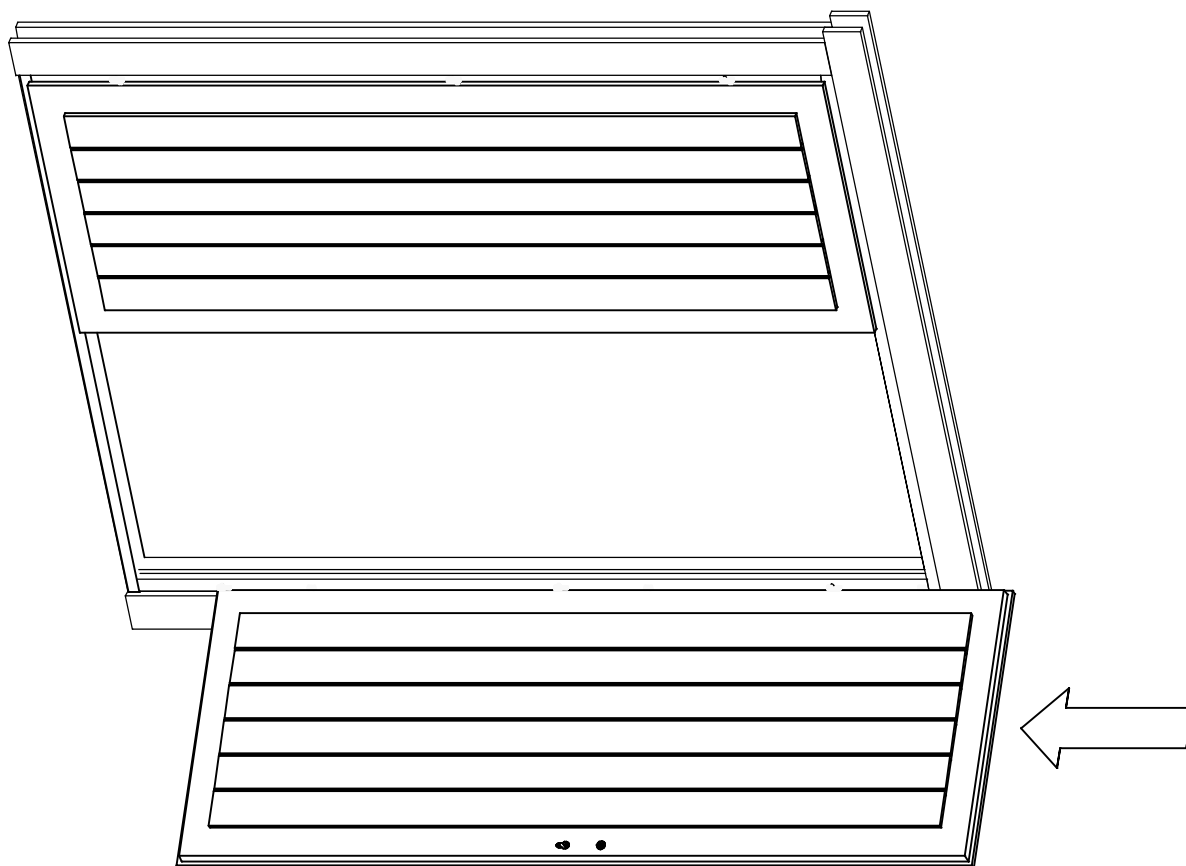
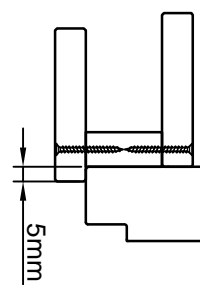
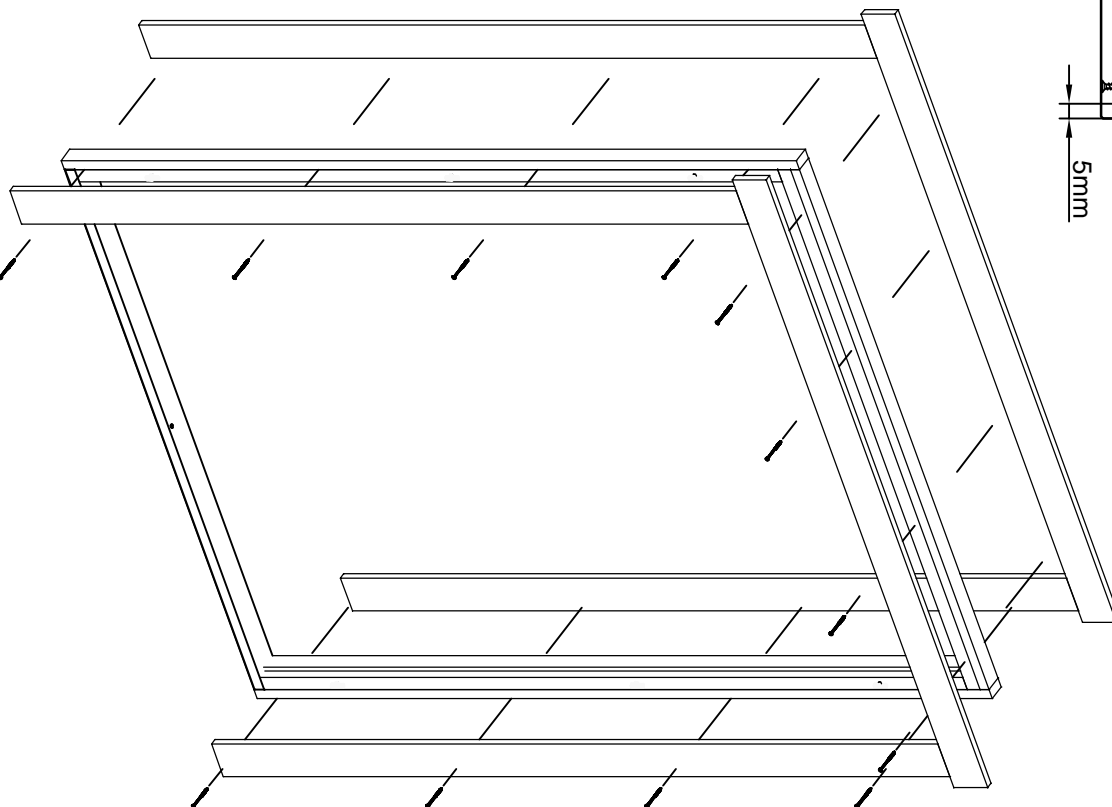

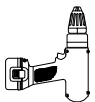
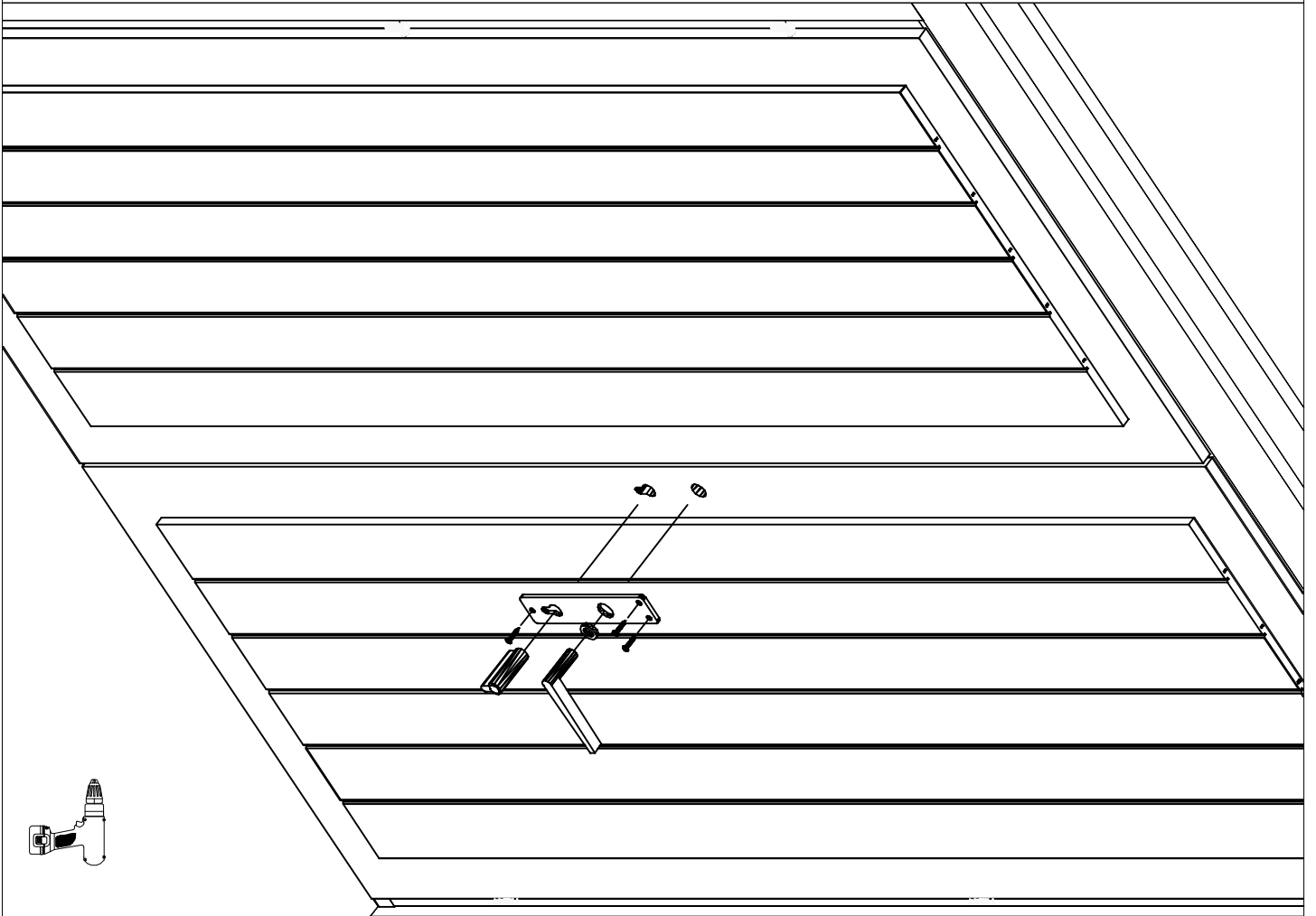
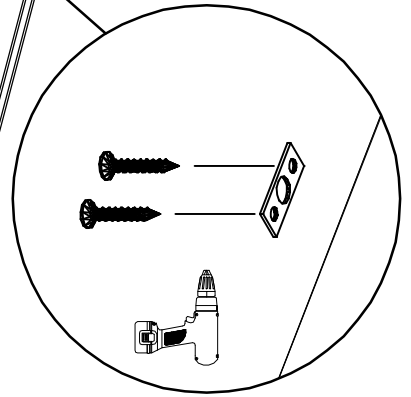
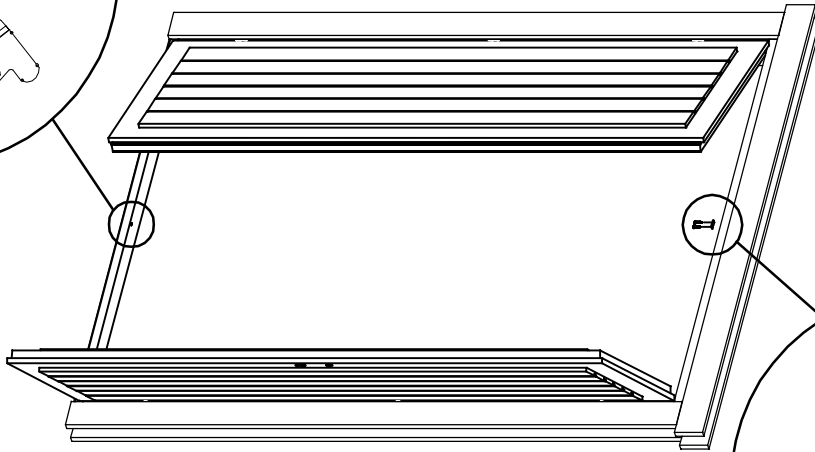
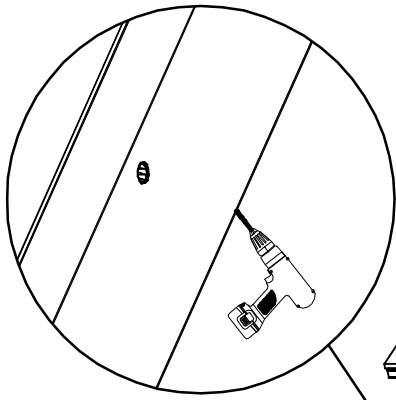

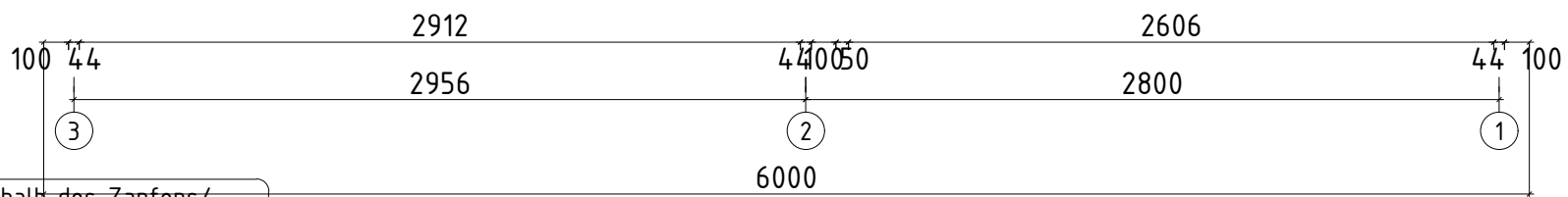
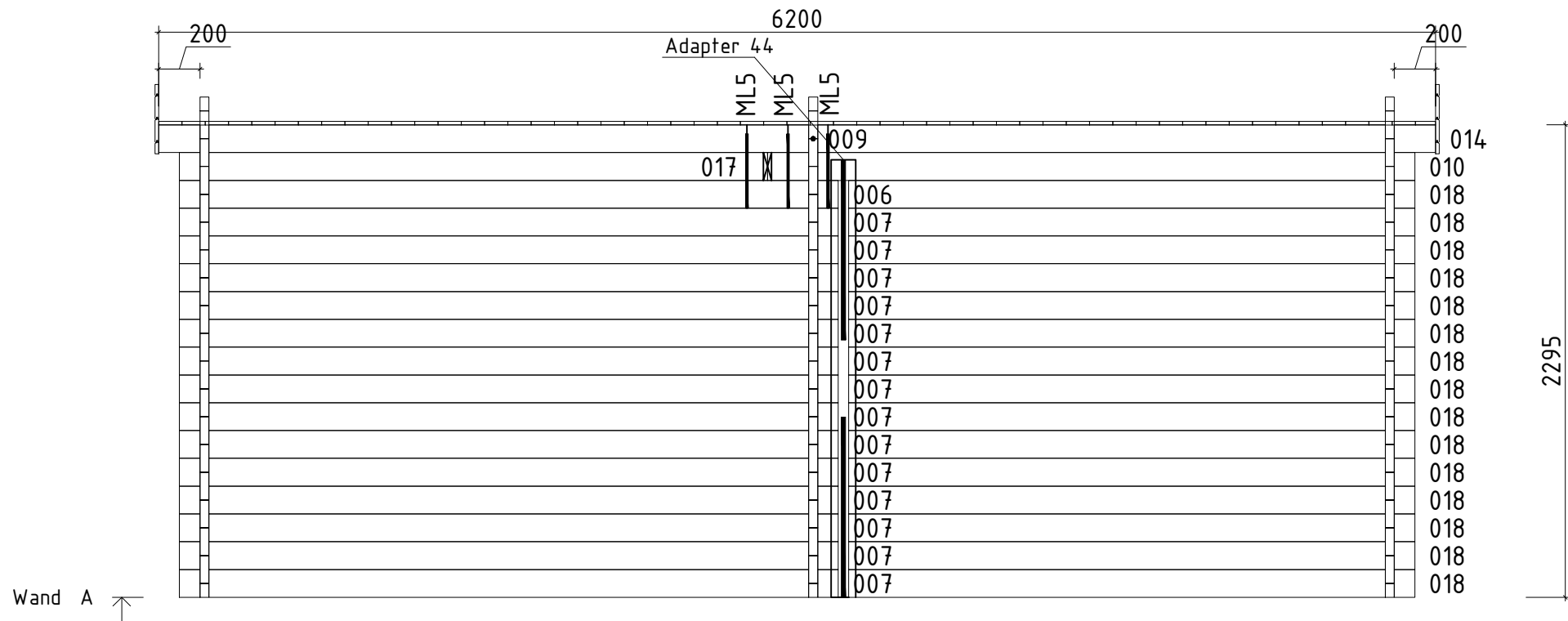

Verbindung innerhalb des Zapfens/  
Inside tenon connection

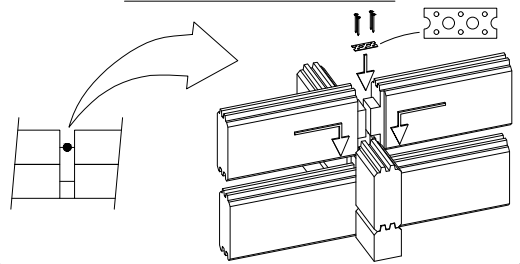

Verbindung mit Holz-klotzen/  
Connection with a wooden wedge

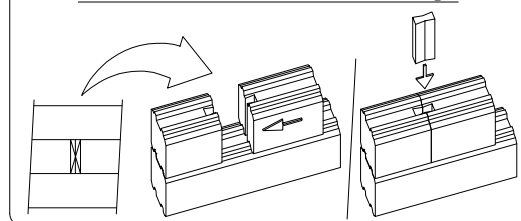

Name	Lucas D 320x320+VD+Terr_44		
Zeichnung/Drawing	WAND A		
Profil/Profile	4.4x13.5	Datum/Date	19.05.2021

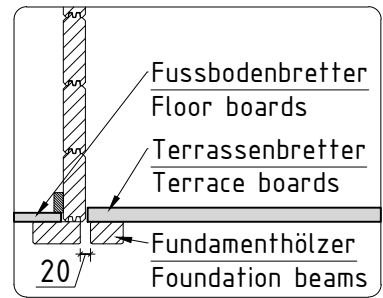
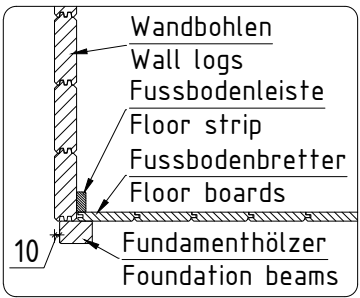
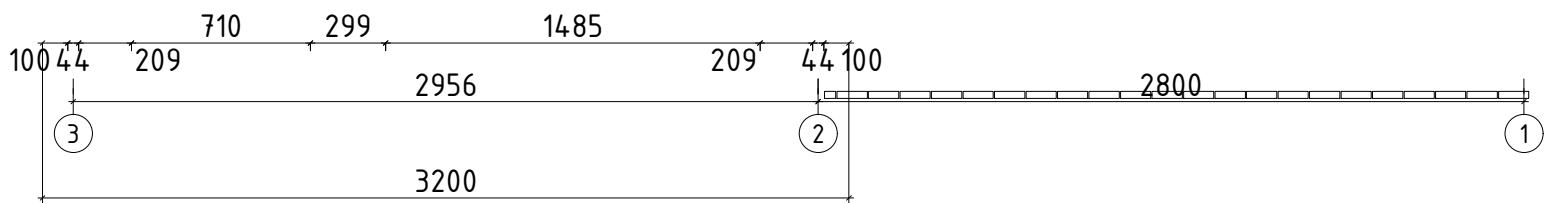
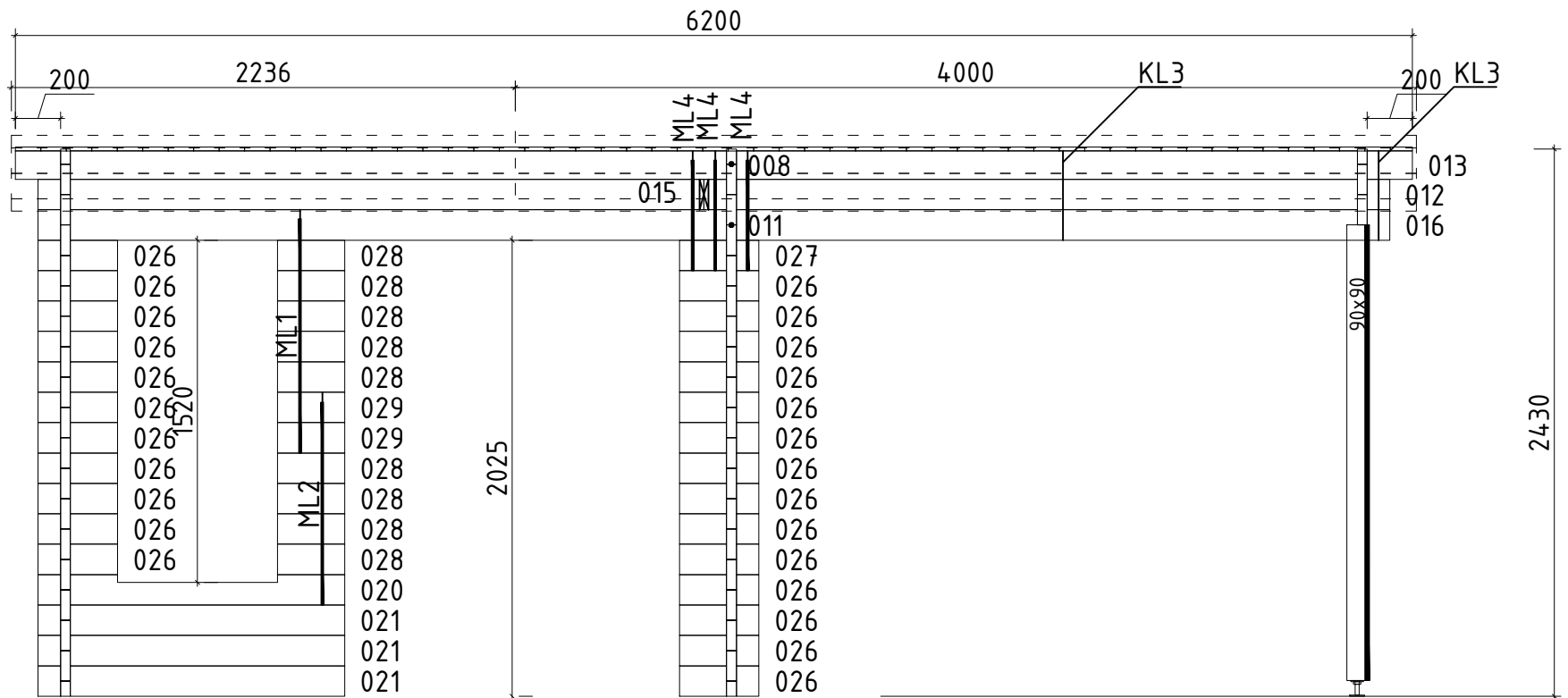

Name	Lucas D 320x320+VD+Terr_44	
Zeichnung/Drawing	WAND B	
Profil/Profile	4.4x13.5	Datum/Date 19.05.2021

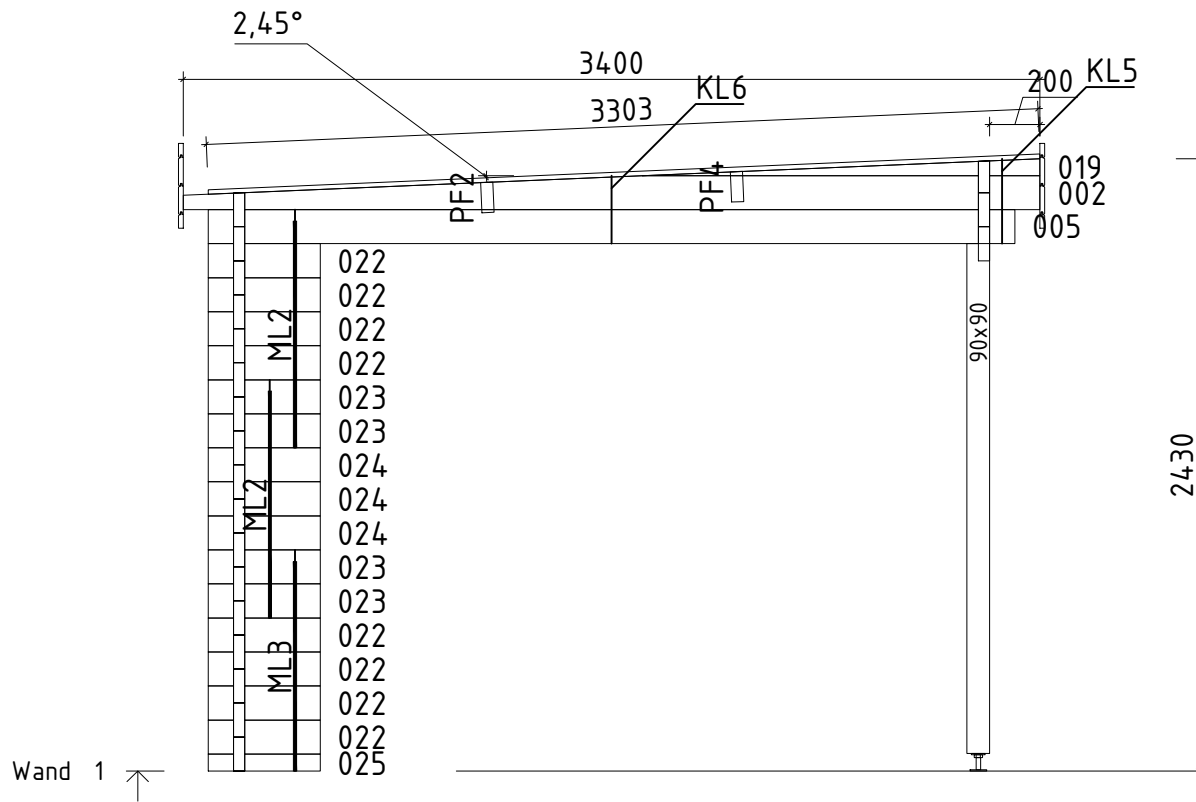

Wand 1 ↗

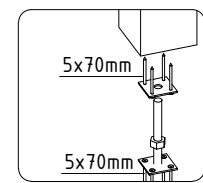
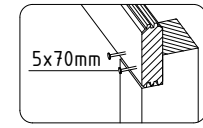
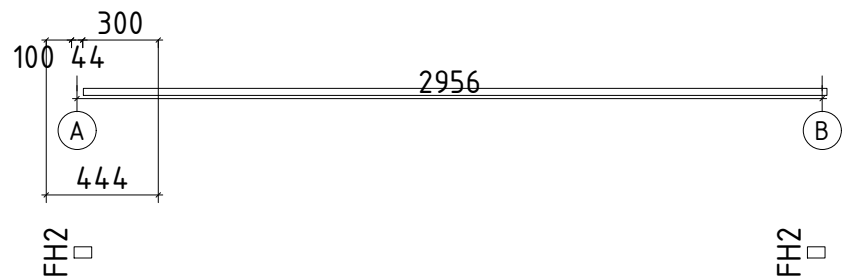

Name	Lucas D 320x320+VD+Terr_44		
Zeichnung/Drawing	WAND 1		
Profil/Profile	4.4x13.5	Datum/Date	19.05.2021

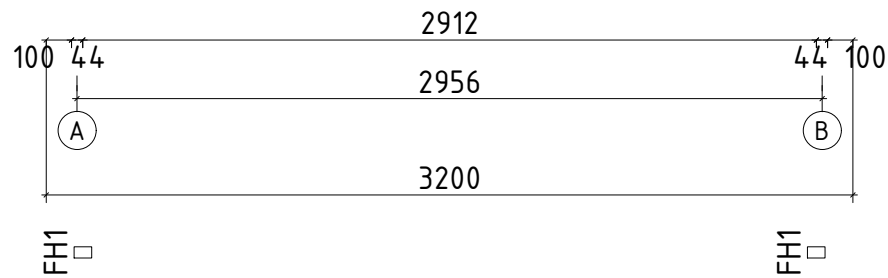
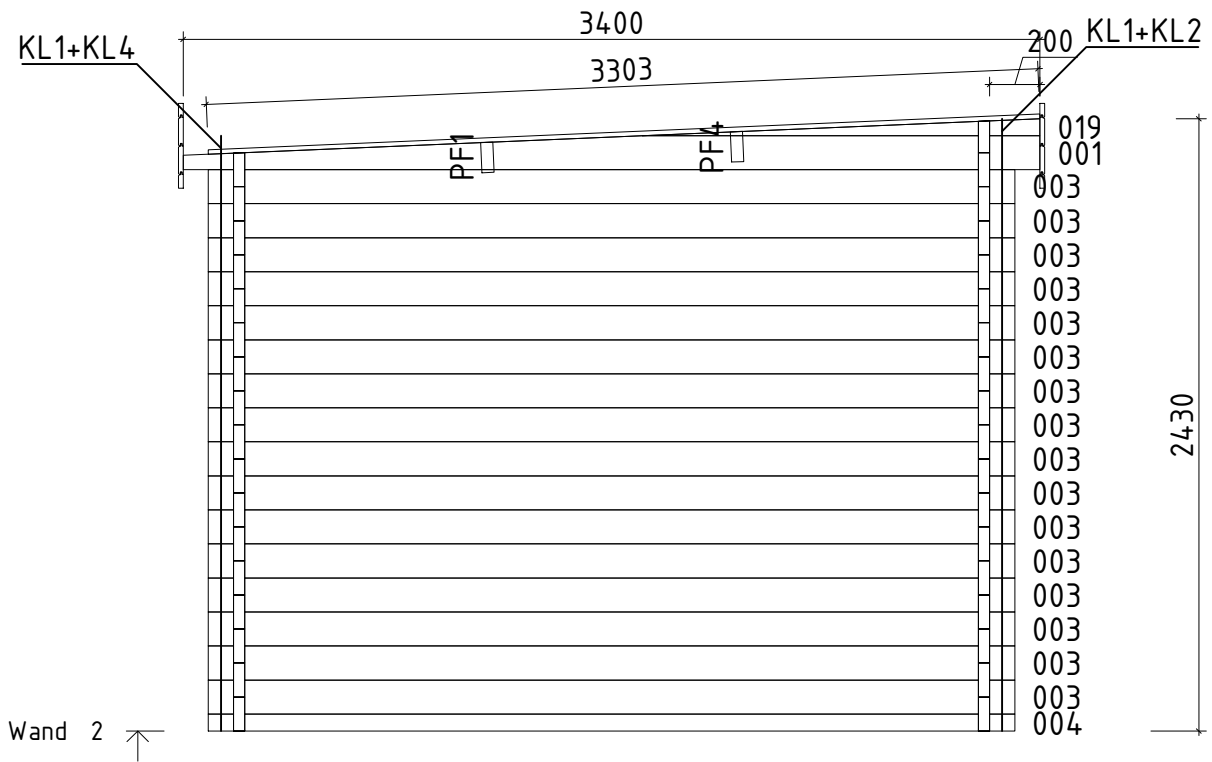

Name	Lucas D 320x320+VD+Terr_44		
Zeichnung/Drawing	WAND 2		
Profil/Profile	4.4x13.5	Datum/Date	19.05.2021



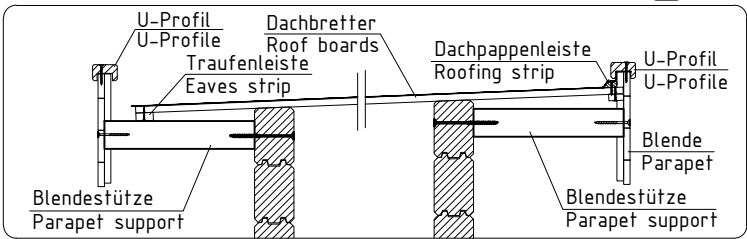
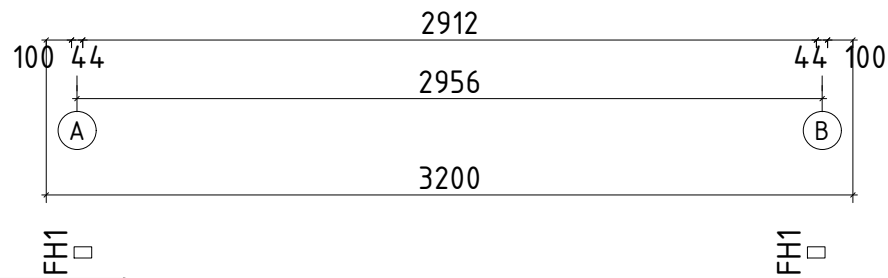
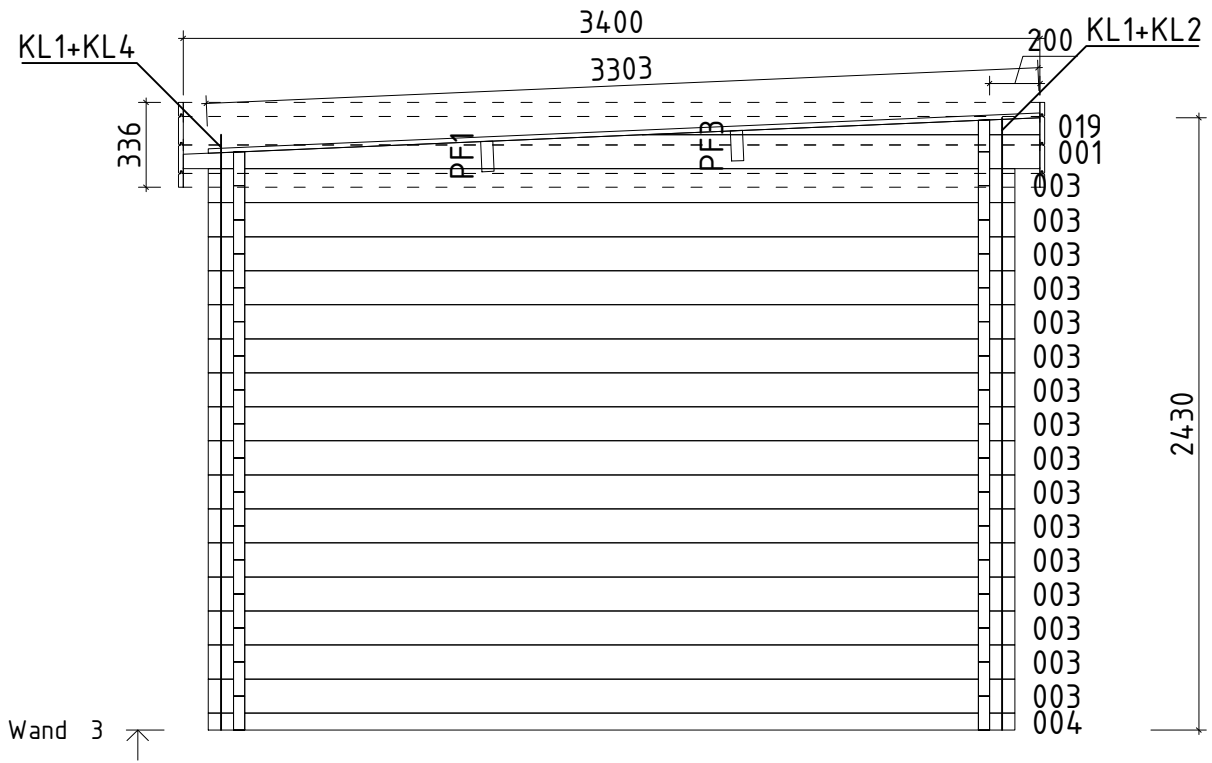

Name	Lucas D 320x320+VD+Terr_44		
Zeichnung/Drawing	WAND 3		
Profil/Profile	4.4x13.5	Datum/Date	19.05.2021