

Name	Maasi 500x500+VD; 58		
Name	Karl 500x500+VD; 58		
Zeichnung/Drawing	3D		
Profil/Profile	5.8x13.5	Datum/Date	15.11.2022

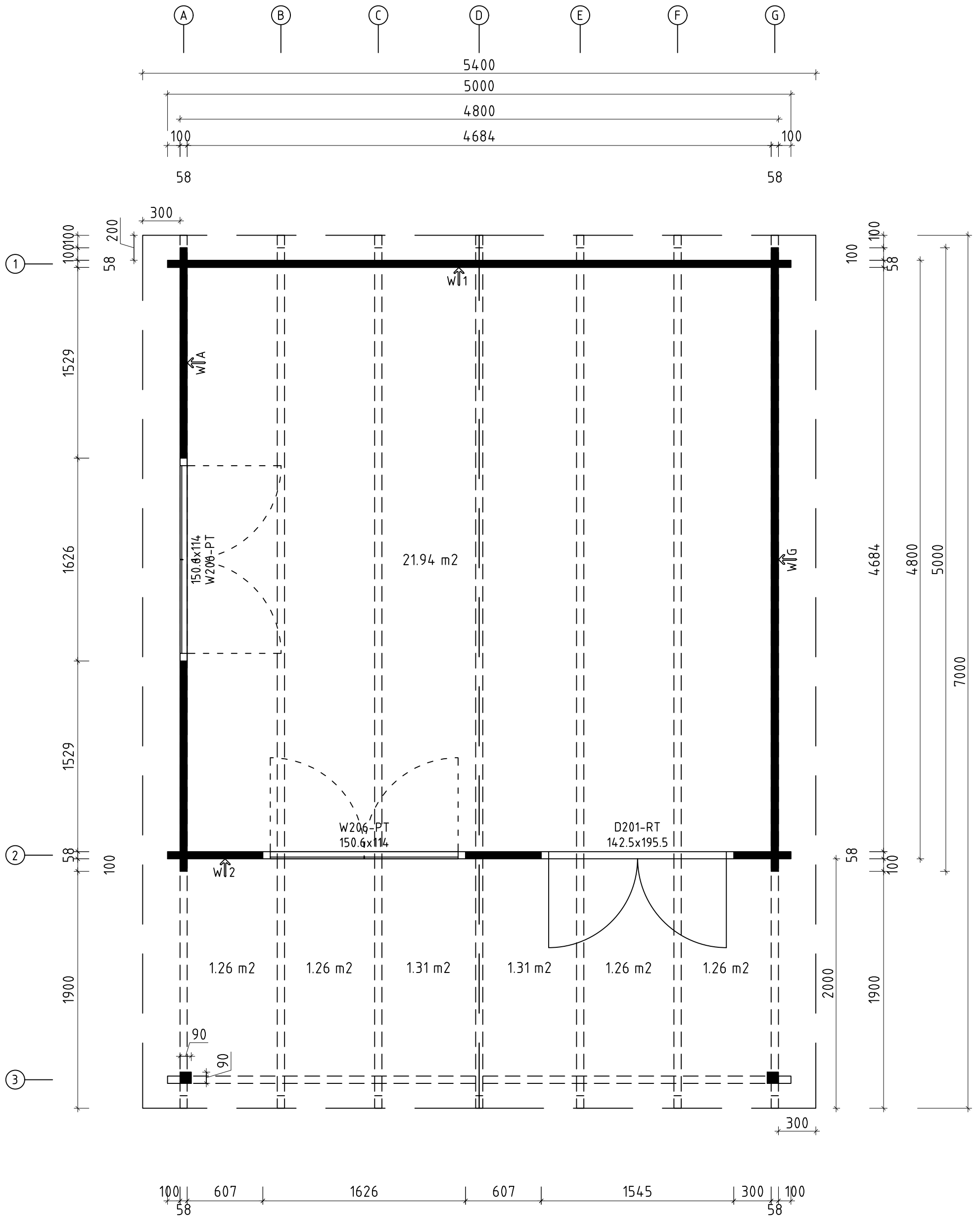





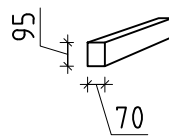
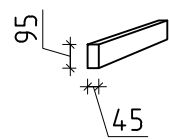
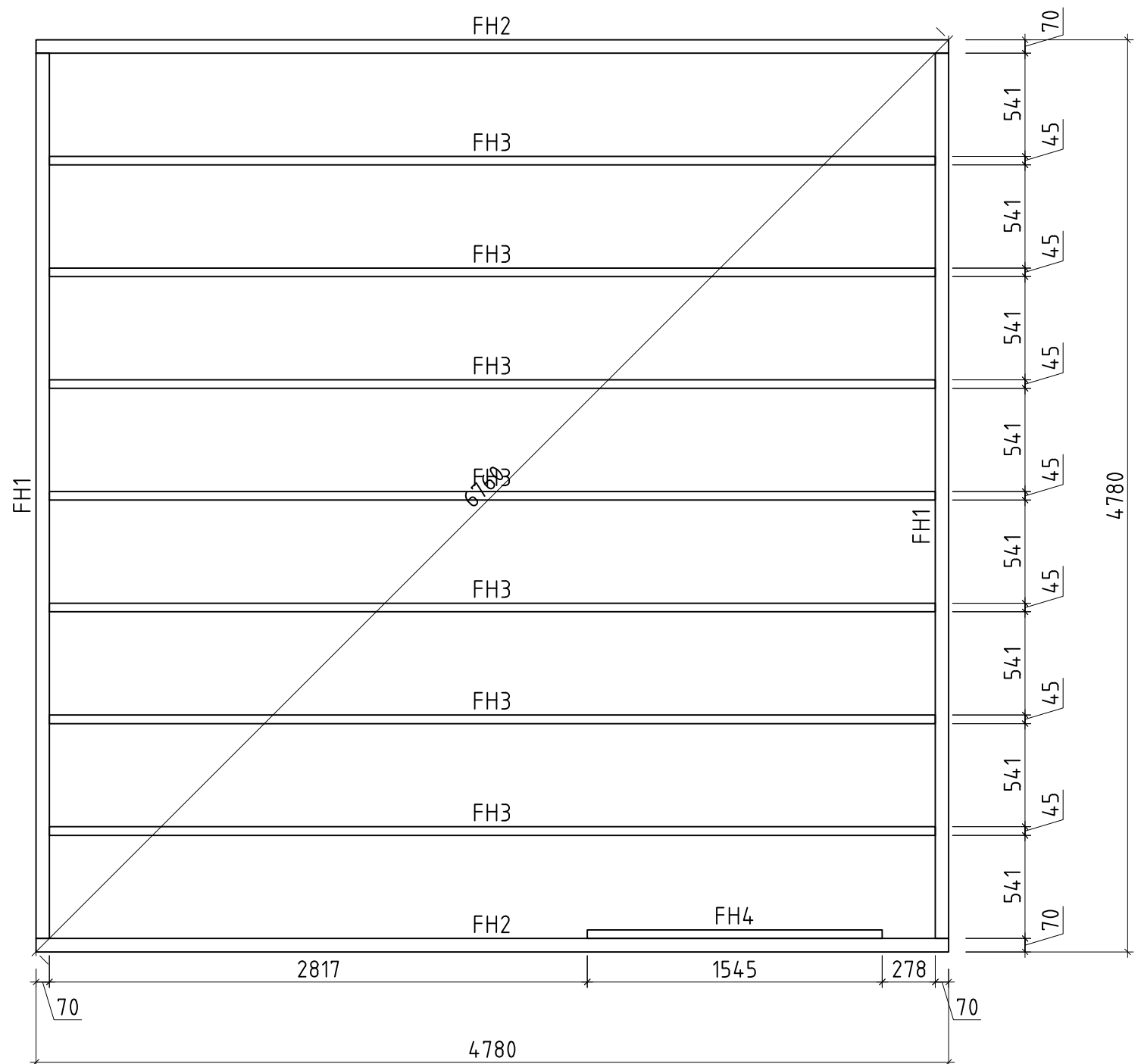

\* Fenster und Türen sind mit Sprossen/  
Windows and doors are with muntins



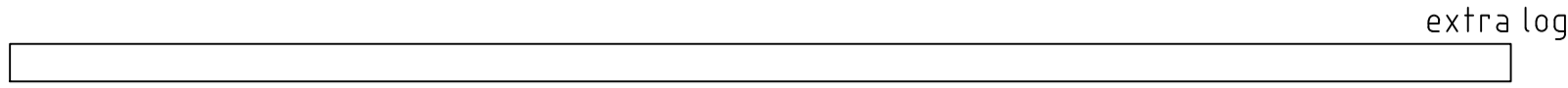
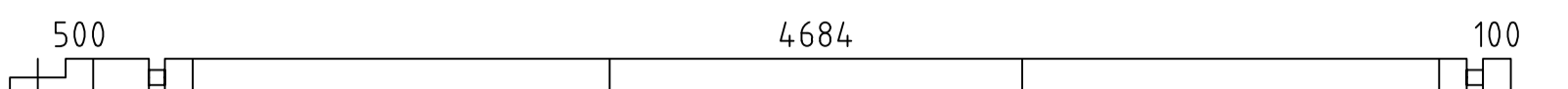

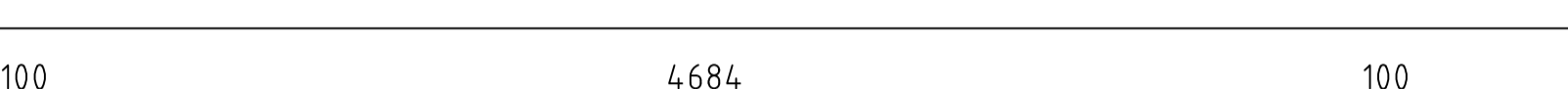
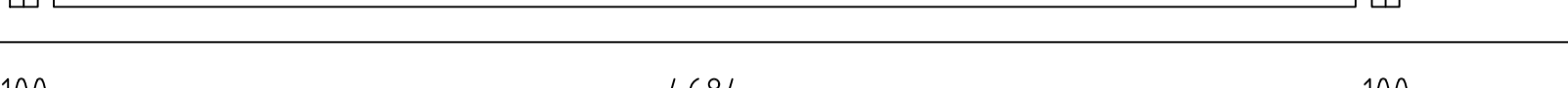
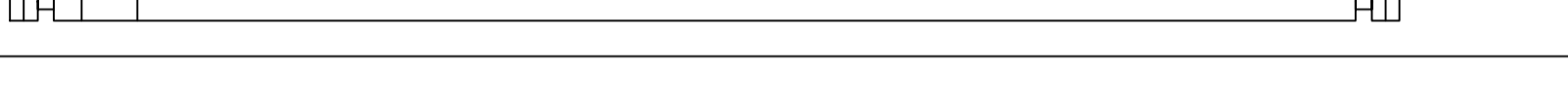
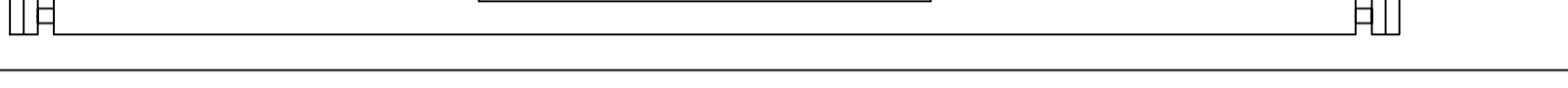
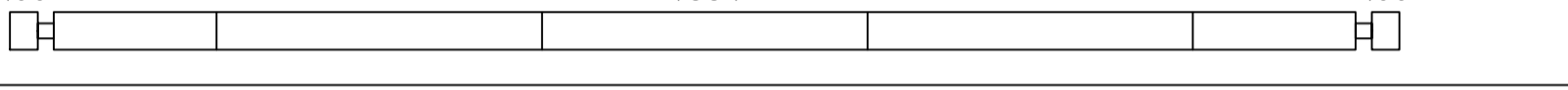
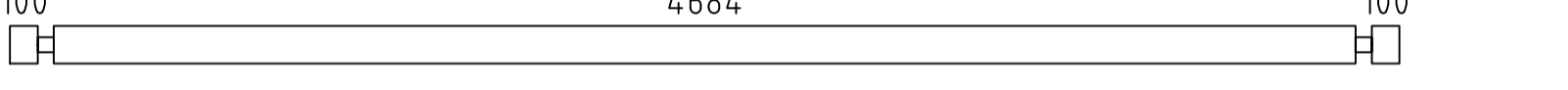
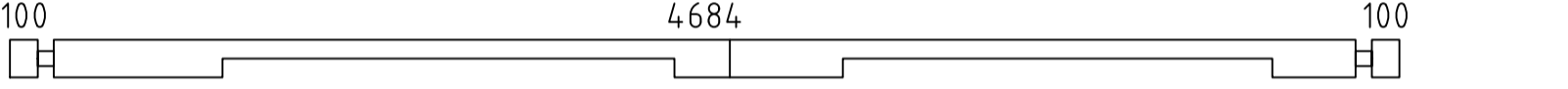
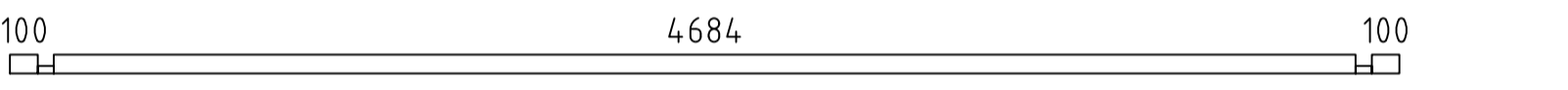

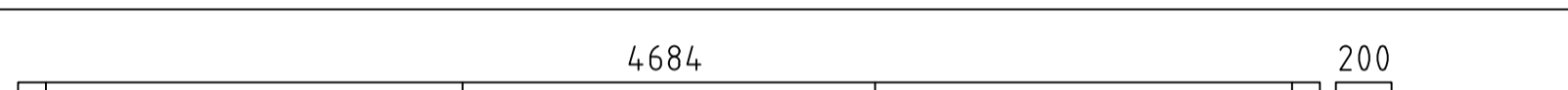

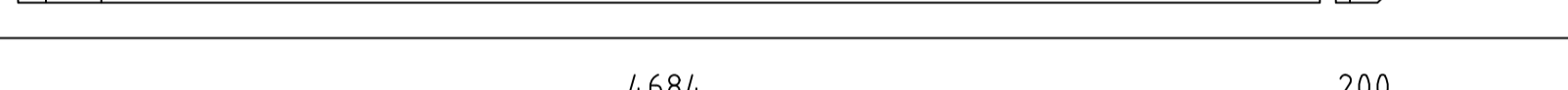
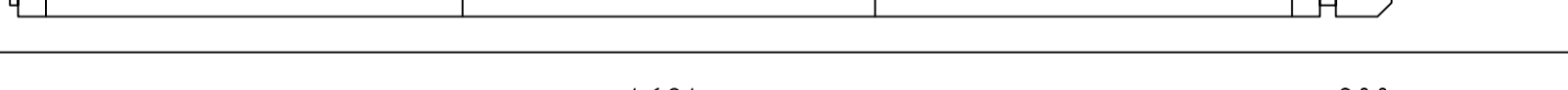
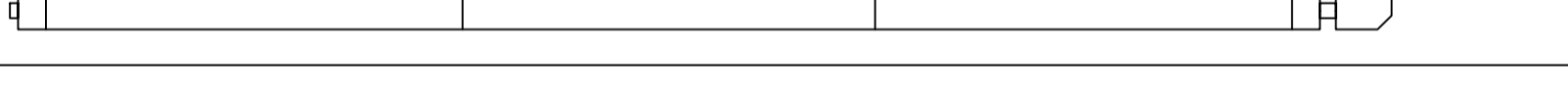
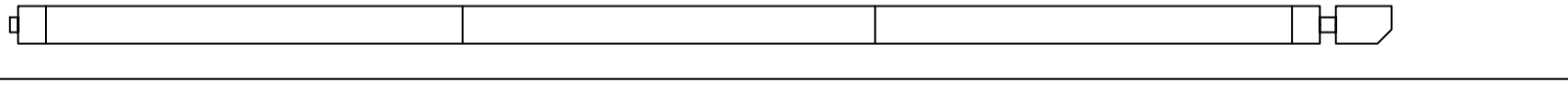
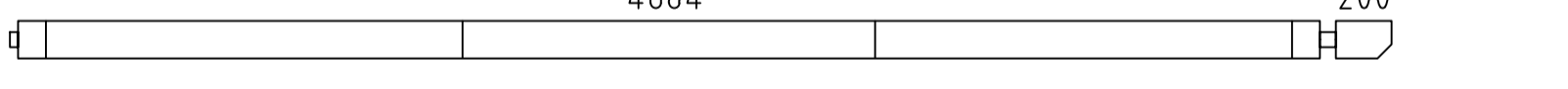
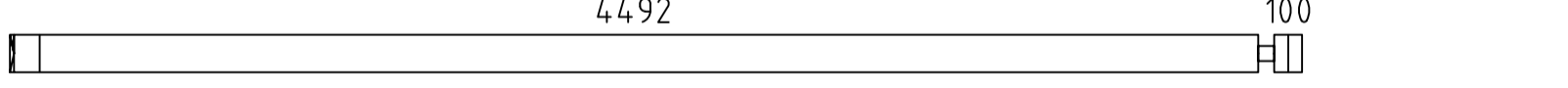
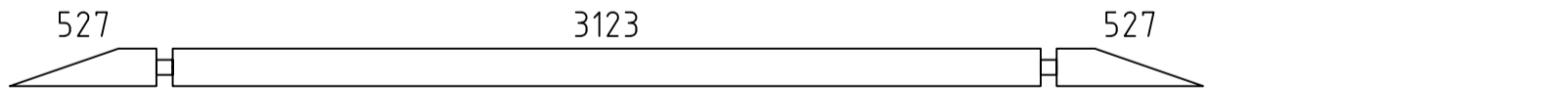
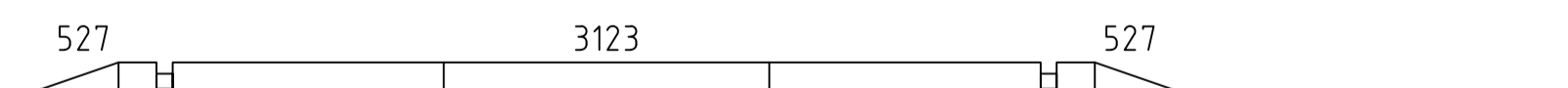
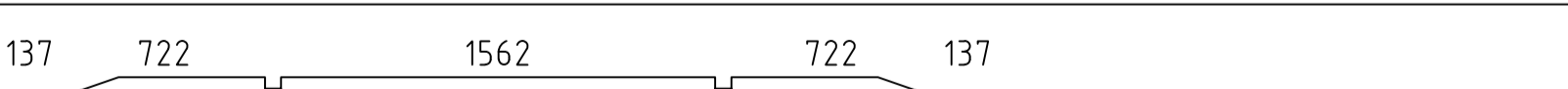
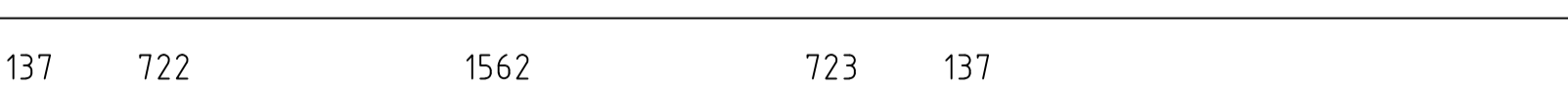
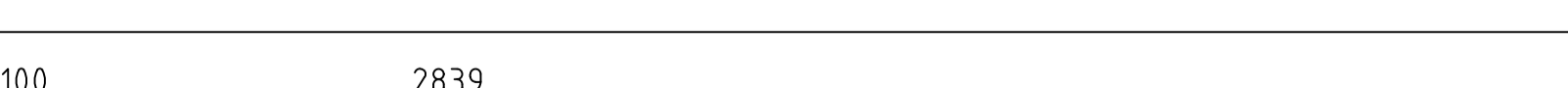
Q5 - Qualitätsklasse für Fenster und Türen/  
Quality class for windows and doors

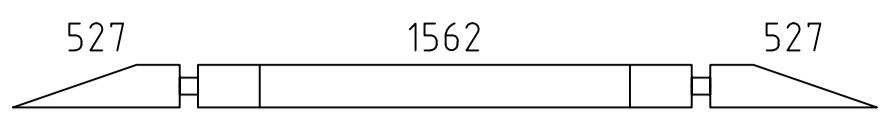
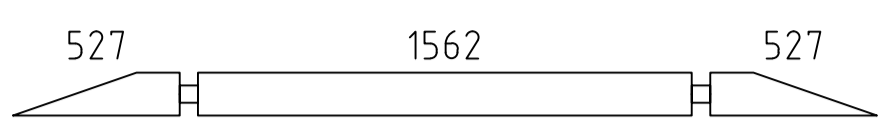
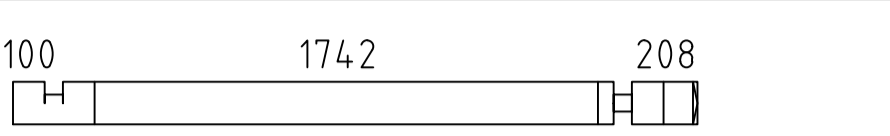
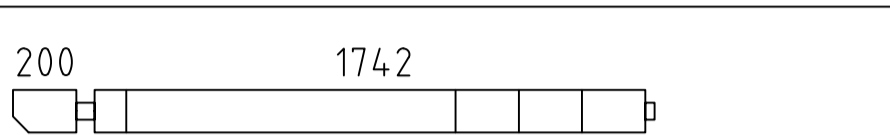
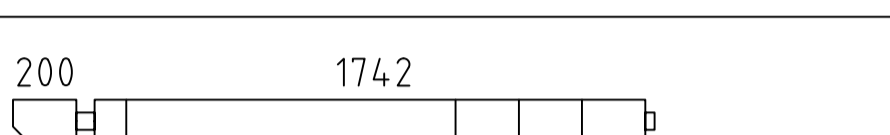
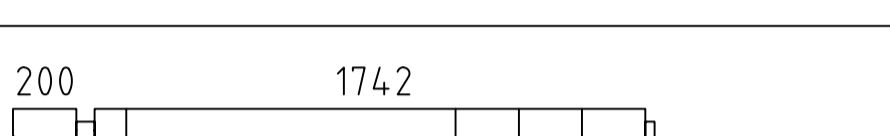
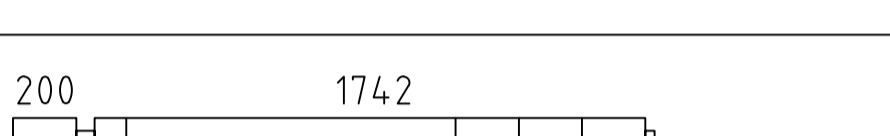
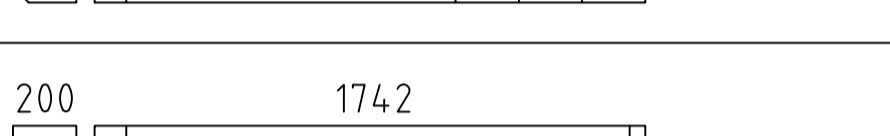
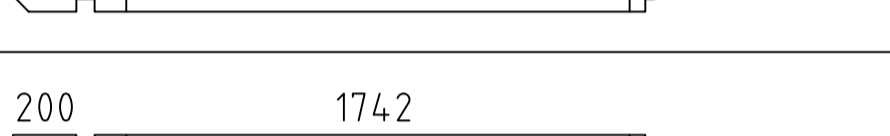
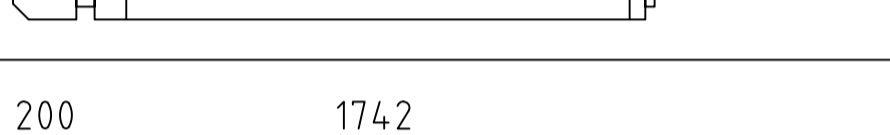
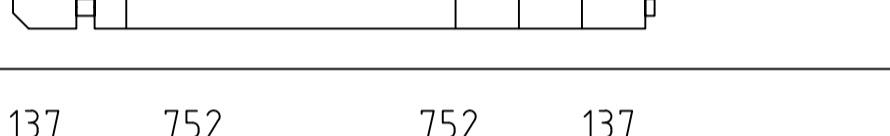
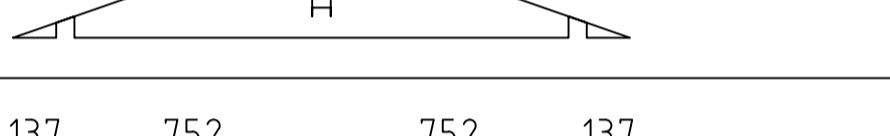
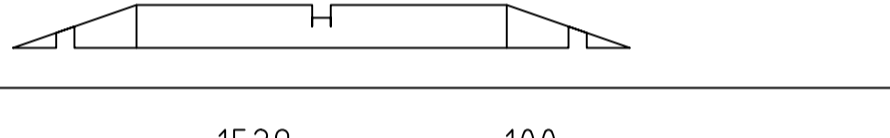
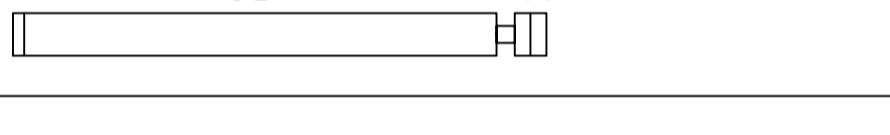
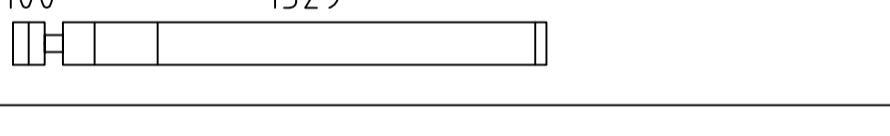
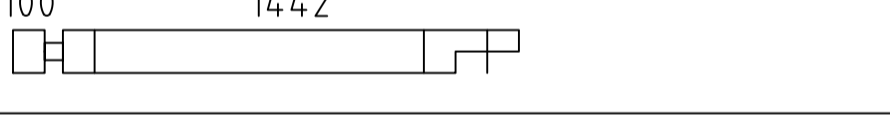
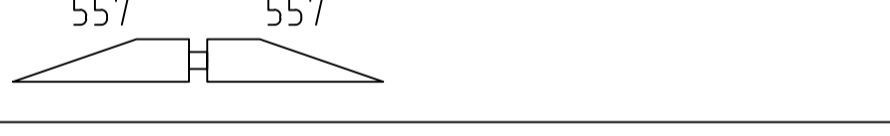





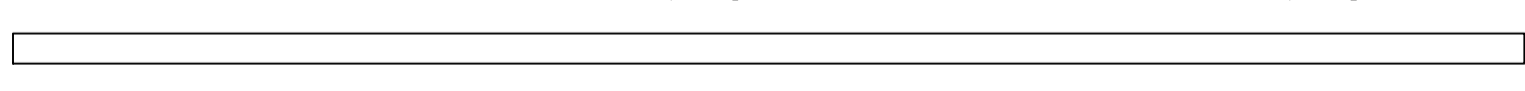

Name	Maasi 500x500+VD; 58	
Name	Karl 500x500+VD; 58	
Zeichnung/Drawing	Grundplan_Plan	
Profil/Profile	5.8x13.5	Datum/Date 15.11.2022

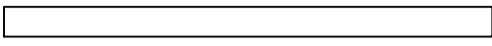
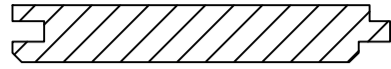
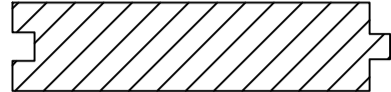

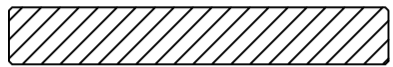
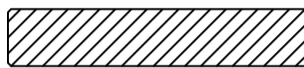

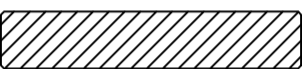

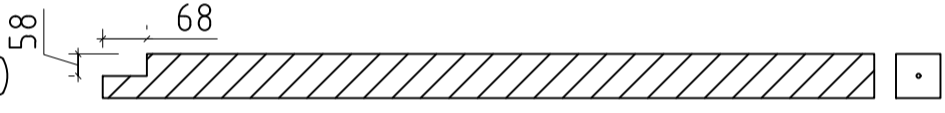
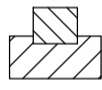
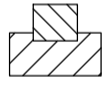
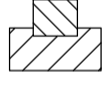
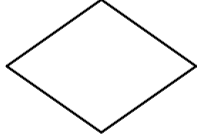
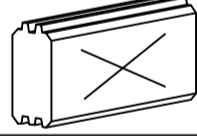
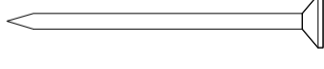
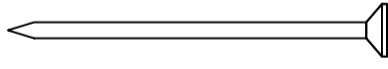
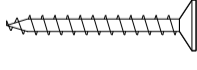
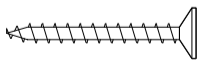
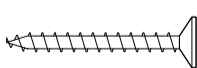
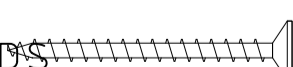

Name	Maasi 500x500+VD; 58		
Name	Karl 500x500+VD; 58		
Zeichnung/Drawing	Lagerholzplan_Foundation beams		
Profil/Profile	5.8x13.5	Datum/Date	15.11.2022

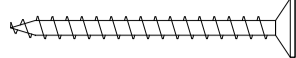
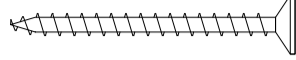
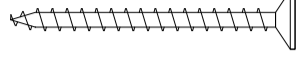
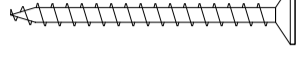
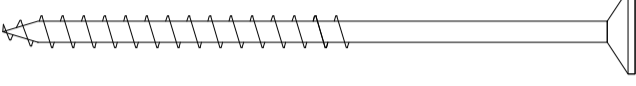
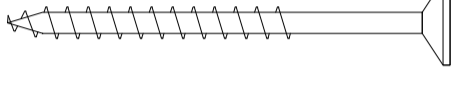
Pos	Teieliste/Specification Maasi 500x500+VD; 58	Stck Pcs.	Profil Profile (mm)	Länge Length (mm)
	<u>Achtung!</u> Die Giebelbohlen können teilweise schon vormontiert sein! Bitte beachten - diese erscheinen nicht ganz so wie in der Teieliste beschrieben.			
	<u>Notice!</u> The gable pieces can be partly pre-assembled! Please notice - those differ from the description given in the specification list.			
000		1	58x135	5400
001		5	58x135	5400
002		2	58x135	5000
003		1	58x135	5000
004		19	58x135	5000
005		1	58x135	5000
006		1	58x135	5000
007		1	58x135	5000
008		17	58x135	5000
009		1	58x135	5000
010		1	58x68	5000
011		1	58x135	4971
012		1	58x135	4971
013		1	58x135	4971
014		1	58x135	4971
015		1	58x135	4971
016		1	58x135	4971
017		1	58x135	4971
018		2	58x135	4650
019		2	58x135	4294
020		1	58x135	4294
021		2	58x135	3513
022		1	58x135	3513
023		1	58x68	2997
024		5	58x135	2997
025		1	58x135	2997
Kood	Maasi 500x500+VD; 58	Materjal	File	Leht 1/5

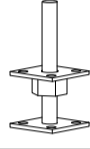
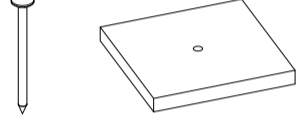
Pos	Teieliste/Specification Maasi 500x500+VD; 58	Stck Pcs.	Profil Profile (mm)	Länge Length (mm)
026		1	58x135	2732
027		2	58x135	2732
028		2	58x135	2166
029		1	58x135	2029
030		1	58x135	2029
031		1	58x135	2029
032		1	58x135	2029
033		1	58x135	2029
034		1	58x135	2029
035		1	58x135	2029
036		2	58x135	1952
037		1	58x135	1952
038		17	58x135	1687
039		1	58x135	1687
040		5	58x135	1600
041		3	58x135	1171
042		8	58x135	765
043		6	58x135	607
044		2	58x135	607
045		1	58x68	458
046		14	58x135	458
047		3	58x68	390
FH2	FUNDAMENTHOLZ (imprägniert) - FOUNDATION BEAM (impregnated) 	2	70x95	4780
FH1	FUNDAMENTHOLZ (imprägniert) - FOUNDATION BEAM (impregnated) 	2	70x95	4640
FH3	FUNDAMENTHOLZ (imprägniert) - FOUNDATION BEAM (impregnated) 	7	45x95	4640

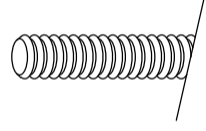
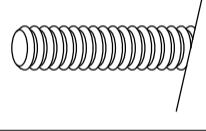
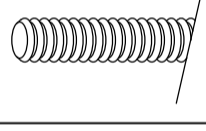
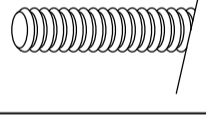
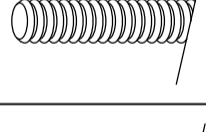
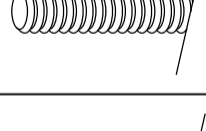
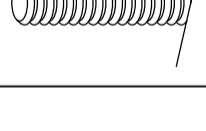
Pos	Teileliste/Specification Maasi 500x500+VD; 58		Stck Pcs.	Profil Profile (mm)	Länge Length (mm)
FH4	FUNDAMENTHOLZ (imprägniert) - FOUNDATION BEAM (impregnated) 		1	45x95	1545
	DACHBRETTER - ROOF BOARDS		124+2	113x18	2857
	FUSSBODENBRETTER - FLOOR BOARDS		42+1	113x28	4679
	FUSSBODENLEISTEN - FLOOR STRIPS	 ✓		14x55	21.0 lfm/rm
	DECKENLEISTEN - CEILING STRIPS	 ✓		15x28	40.0 lfm/rm
G02-1	GIEBELBRETTER - GABLE BOARDS 18x120	19.1°  ✓	4	18x120	2937
G01-1	GIEBELBRETTER - GABLE BOARDS 18x95	19.1°  ✓	4	18x95	2937
G06-1	GIEBELDECKLEISTEN - GABLE COVER STRIPS 18x58	 ✓	4	18x58	2937
G08-1	GIEBELLEISTEN - GABLE STRIPS 18x58	19.1°  ✓	4	18x58	2937
T01-1	TRAUFENBRETTER - EAVES BOARDS 18x95		4	18x95	3500
T06-1	TRAUFENLEISTEN - EAVES STRIPS 18x40	 ✓		18x40	14.0 lfm/rm
TP90-1	STÜTZPFOSTE - SUPPORT POST 90x90	 ✓	2	90x90	2093
TL58-1	T-LEISTEN - T-STRIPS 58		2	45x58	1030
TL58-2	T-LEISTEN - T-STRIPS 58		2	45x58	1165
TL58-3	T-LEISTEN - T-STRIPS 58		2	45x58	1908
GS	GIEBELSEGMENT - GABLE DIAMOND		2		
SH	SCHLAGHÖLZER - MOUNTING PIECES		3		
NG2 550	NÄGEL - NAILS 2.5x50 Dachbretter - Roof boards		992		
NG2 560	NÄGEL - NAILS 2.5x60 Fussbodenbretter - Floor boards		756		
SR3 030	Schrauben - Screws 3.0x30 Deckenleisten - Ceiling strips		80		
SR3 030	Schrauben - Screws 3.0x30 Fussbodenleisten - Floor strips		38		
SR3 030	Schrauben - Screws 3.0x30 Traufenleisten - Eaves strips		28		
SR37	Schrauben - Screws 3.5x45 Fenster/Türleisten - Door/Window strips		80		
SR3 545	Schrauben - Screws 3.5x45 Giebelbretter - Gable boards		48		
SR3 545	Schrauben - Screws 3.5x45 Giebeldeckleisten - Gable cover strips		24		
Kood	Maasi 500x500+VD; 58	Materjal	File		Leht 3/5

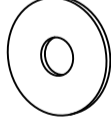
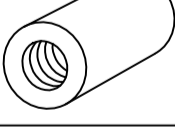
Pos	Teileliste/Specification Maasi 500x500+VD; 58		Stck Pcs.	Profil Profile (mm)	Länge Length (mm)
SR3 545	Schrauben - Screws 3.5x45	Giebelleisten - Gable strips		24	
SR3 545	Schrauben - Screws 3.5x45	Giebelsegment - Gable diamond		4	
SR3 545	Schrauben - Screws 3.5x45	Traufenbretter - Eaves boards		28	
SR354 5-001	Schrauben - Screws 3.5x45	Verbindungsstreifen - Connecting strip		28	
SR5 0100	Schrauben - Screws 5.0x100	Fundamenthölzer - Foundation beams		48	
SR5 070	Schrauben - Screws 5.0x70	Stützpfole - Support post		12	
VS	Verbindungsstreifen für verbinden der Wandbohlen - Connecting strip for connecting the wall parts			7	
VP2	Verstellbare Pfostenstütze - Adjustable post support M16			2	
KN01	die Fliese mit Nagel 2.0x40 (für Zapfenfüllung) - A tile with a nail 2.0x40 (to support a tenon)			15	
ML1	Metallstange - Metal bar			2	D10 770
ML2	Metallstange - Metal bar			4	D10 360
KL1	Gewindestange - Threaded Rod M8			4	2000
KL2	Gewindestange - Threaded Rod M8			2	810
KL3	Gewindestange - Threaded Rod M8			2	405
KL4	Gewindestange - Threaded Rod M8			4	325
KL5	Gewindestange - Threaded Rod M8			10	270
KL6	Gewindestange - Threaded Rod M8			16	270
KL7	Gewindestange - Threaded Rod M8			16	270
KV M UT M8	Mutter - Nut M8			100	
KV S EIB M8X25	U-Scheibe - Washer M8 Ø25			100	
KV MU TJ M8	Befestigungsmutter - Fixing nut M8			4	
Kood	Maasi 500x500+VD; 58	Materjal	File	Leht	4/5

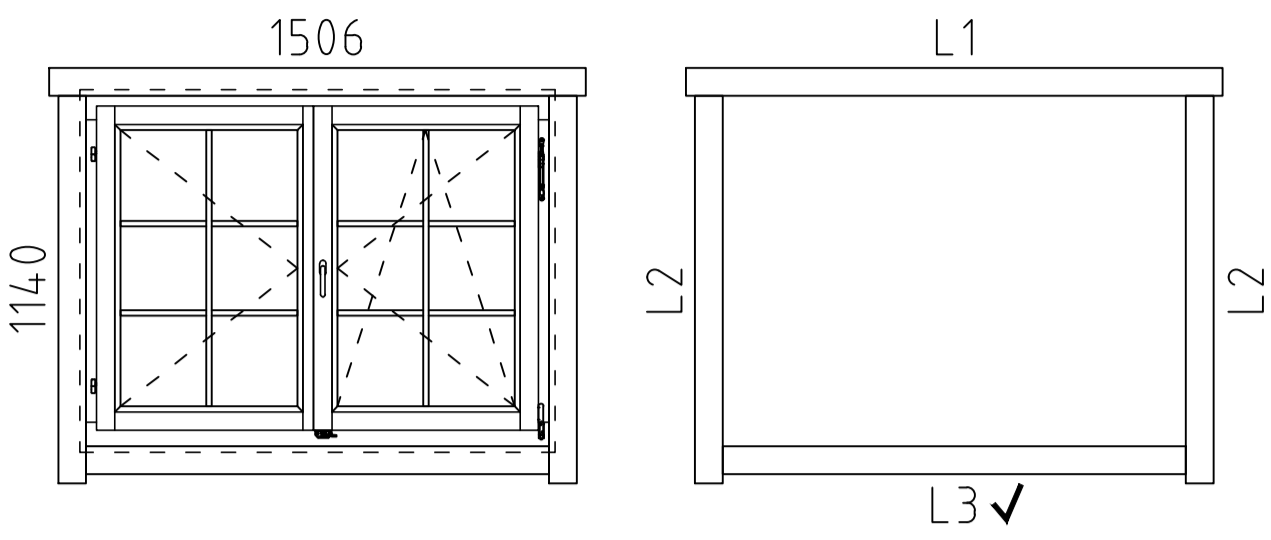
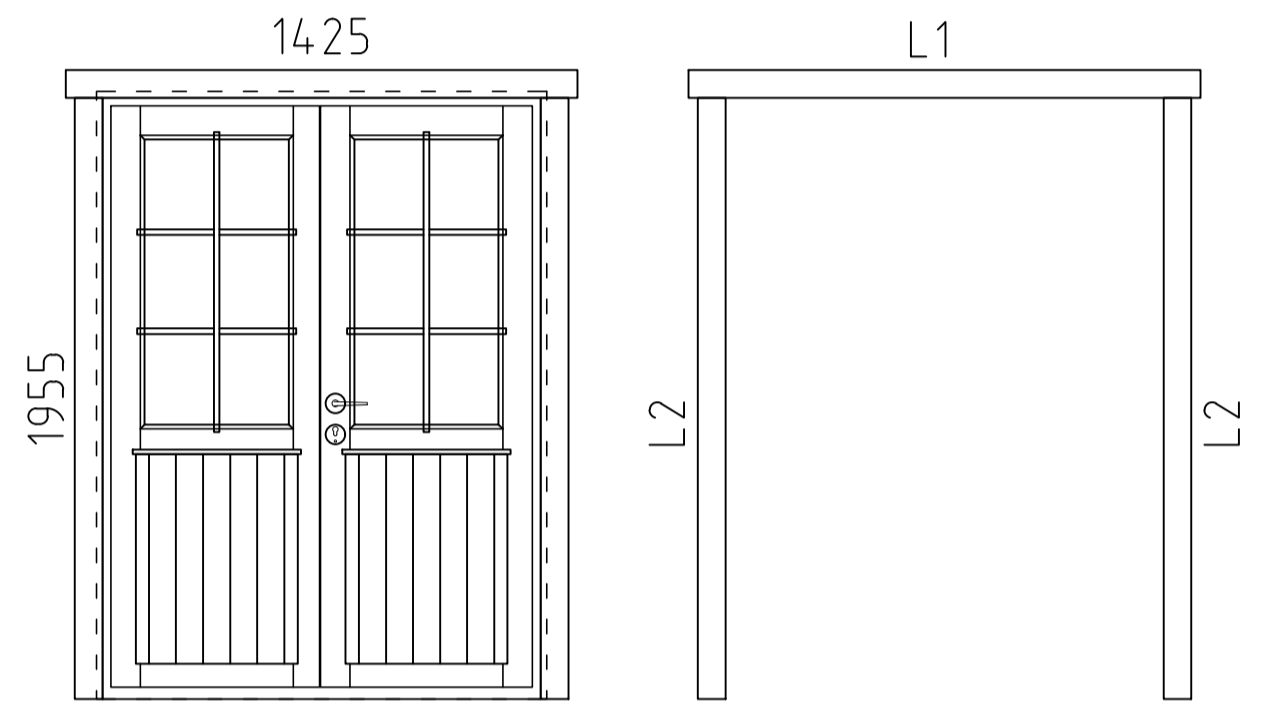
Pos	Teileliste/Specification Maasi 500x500+VD; 58	Stck Pcs.	Profil Profile (mm)	Länge Length (mm)
	<p>FENSTER/WINDOW Q5 W5-D58P-06T-15061140</p>  <p>W206-PT</p> <p>L1 18x90 L=1745mm 2x L2 18x90 L=1260mm 4x L3 18x90 L=1505mm 2x ✓</p>	2		
	<p>TÜR/DOOR Q5 D5-D58R-56T-14251955</p>  <p>D201-RT</p> <p>L1 18x90 L=1665mm 2x L2 18x90 L=1955mm 4x ✓</p> <p>DIN rechts / right handed</p>	1		
	<p>✓ - Bitte selber anpassen (falls nötig)! / Cut into length on site (if needed)!</p>			
Kood	Maasi 500x500+VD; 58	Materjal	File	Leht 5/5



# Montageanleitung für T-Leisten / Installing the door and window supports / Tenderliistu paigaldusjuhend.

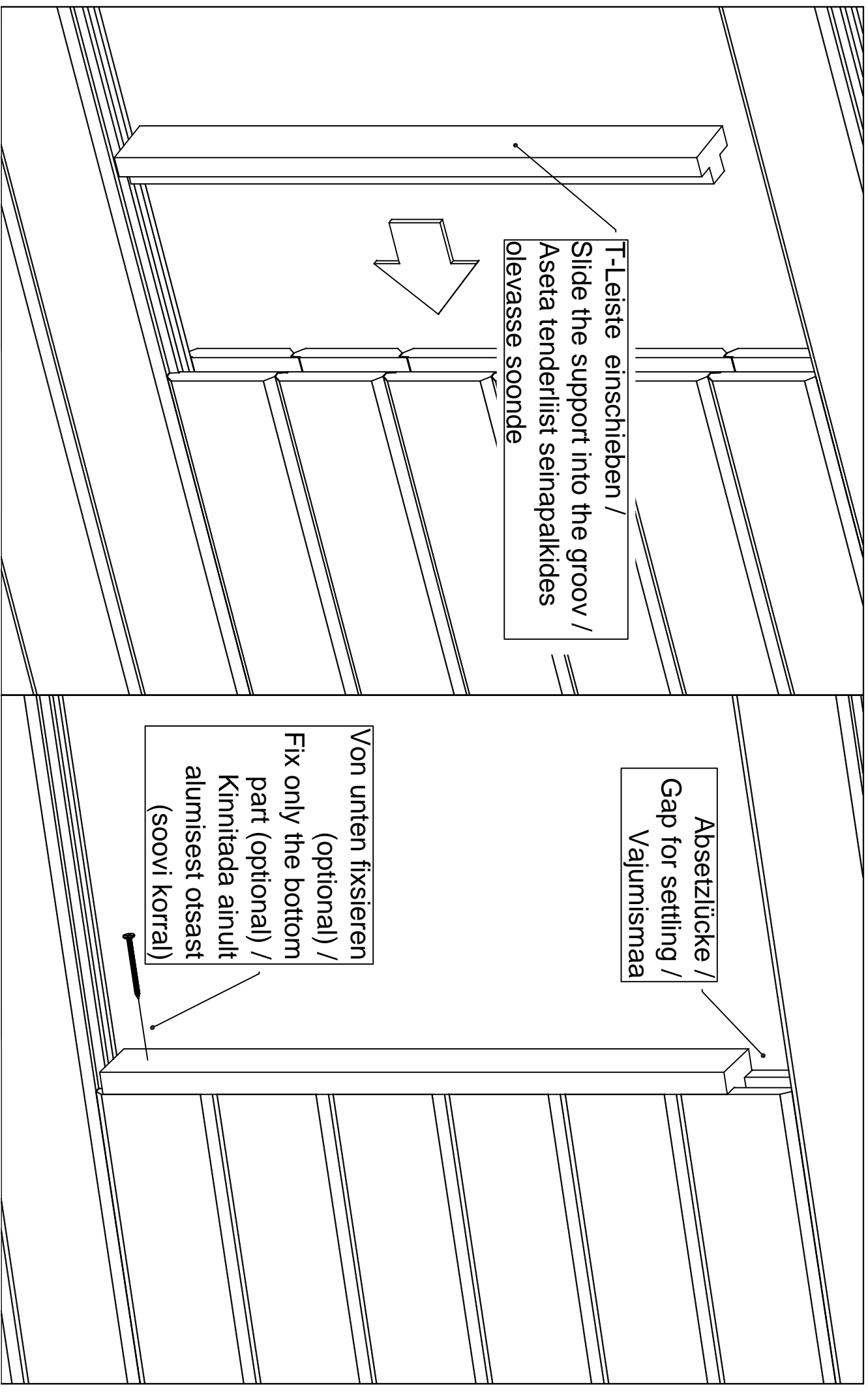

Aken	Q4-Q6	-	paigaldusjuhis
Window	Q4-Q6	-	assembly instructions
Fenster	Q4-Q6	-	Montageanleitung

5-10mm

3.5x45

Lõika mõõtu  
Cut to length  
Absägen  
- 10mm / -20mm

**NB!**

3.5x45

1



- \*Silikooni tiip
- \*Silicon stripe
- \*Silikon Streifen

2



- \*Pleki positsioon
- \*Window sill position
- \*Fensterbank position

3



- \*Silikooni tiip
- \*Silicon stripe
- \*Silikon Streifen

1



- \*Silikooni tiip
- \*Silicon stripe
- \*Silikon Streifen

2

4,2x16

F

F

Ukse montaa 0 / Tür montage / Door assembly  
(GH+ / SH)

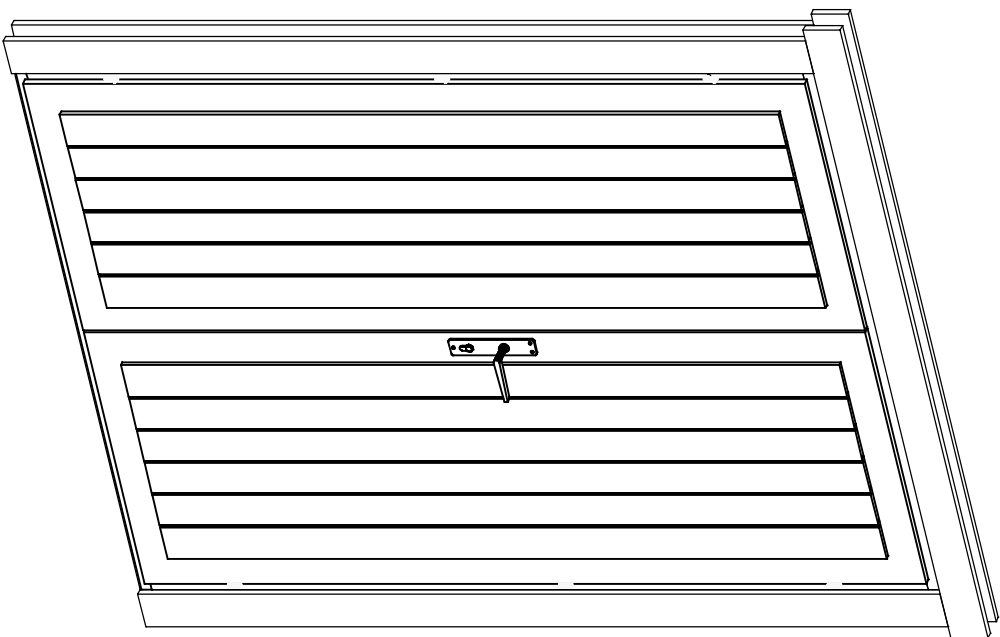

4.5x90

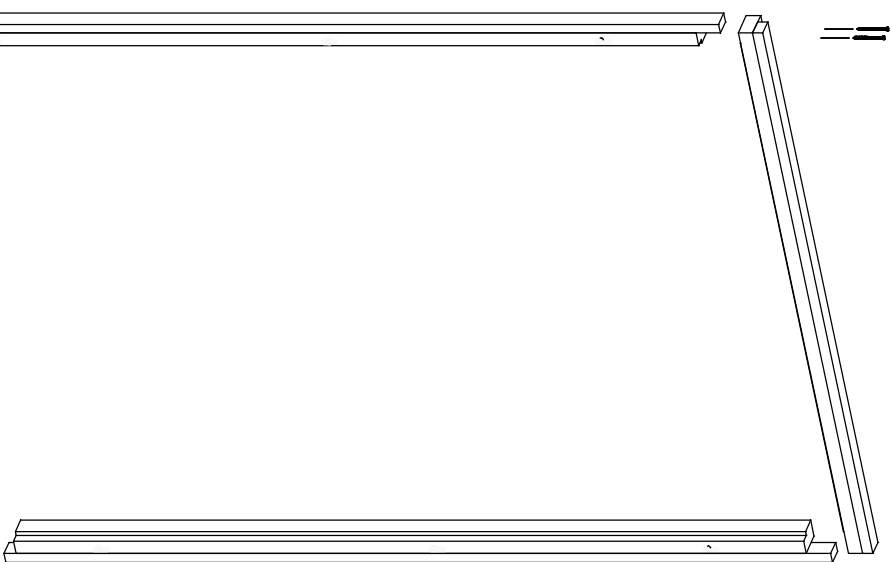

4.5x90



3.5x45

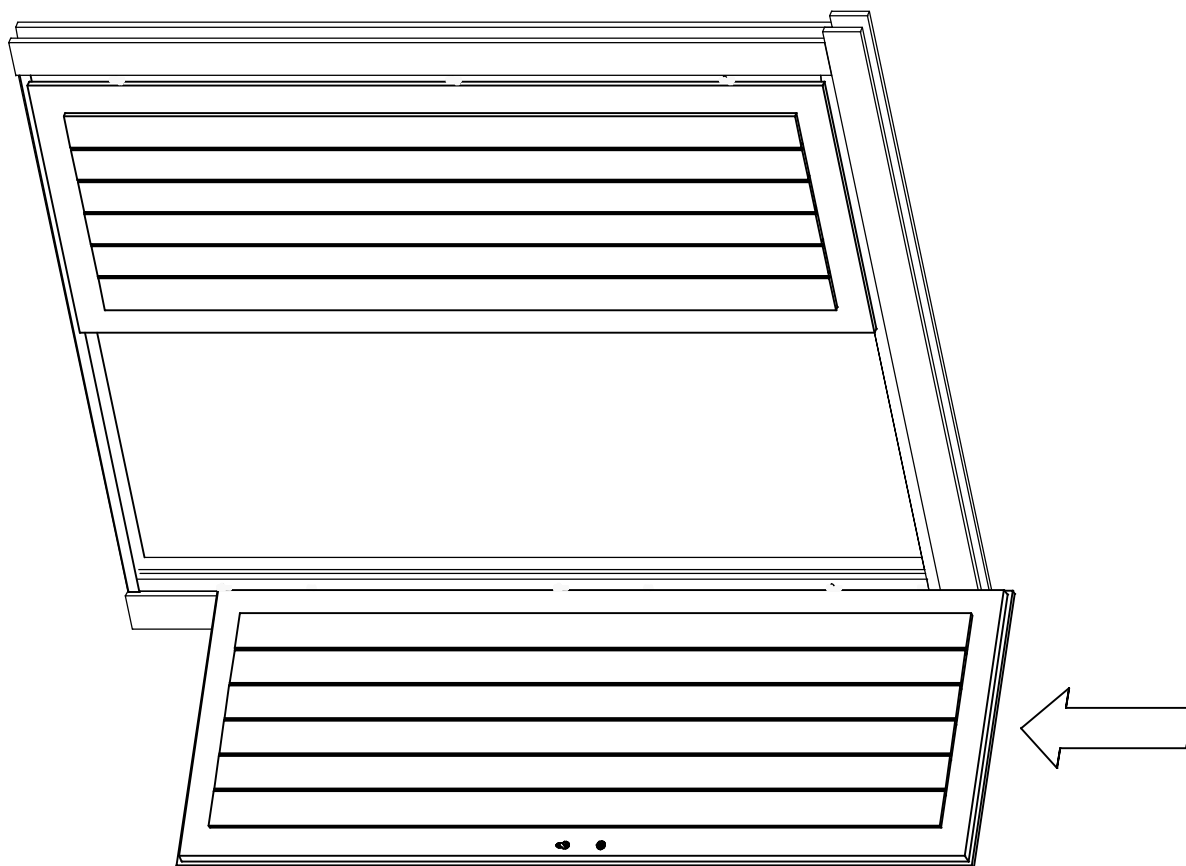
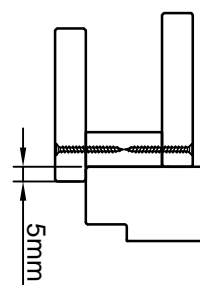
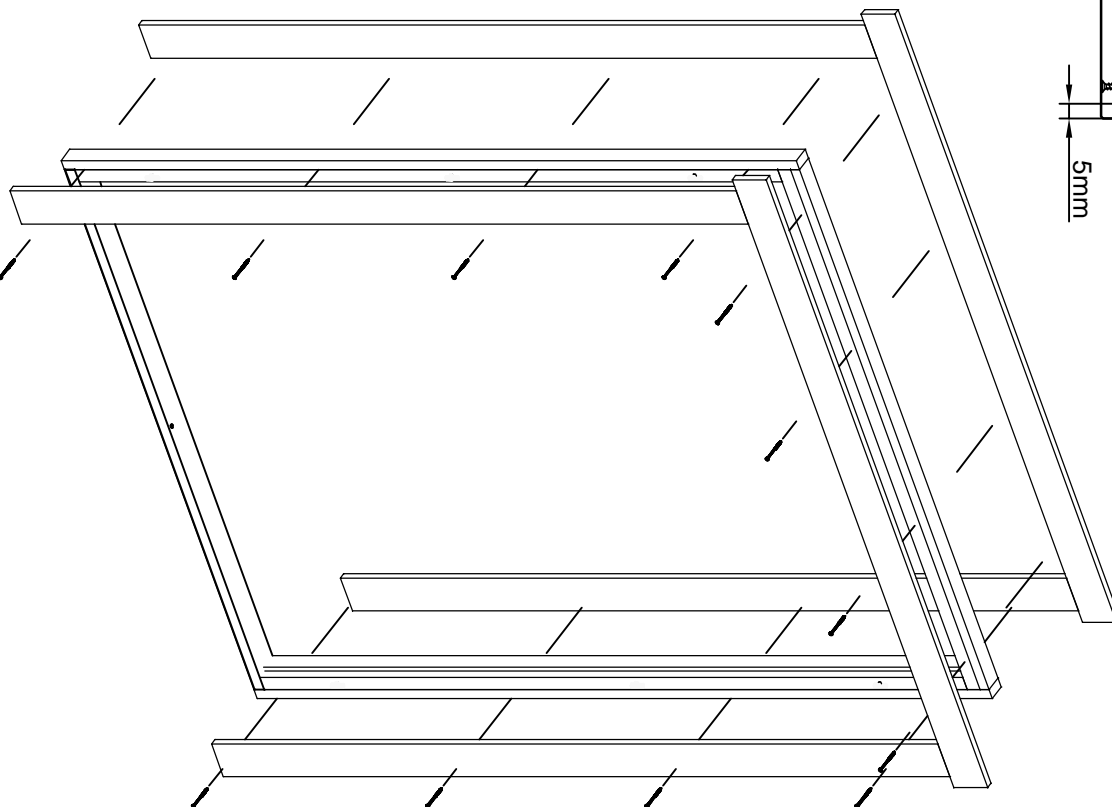

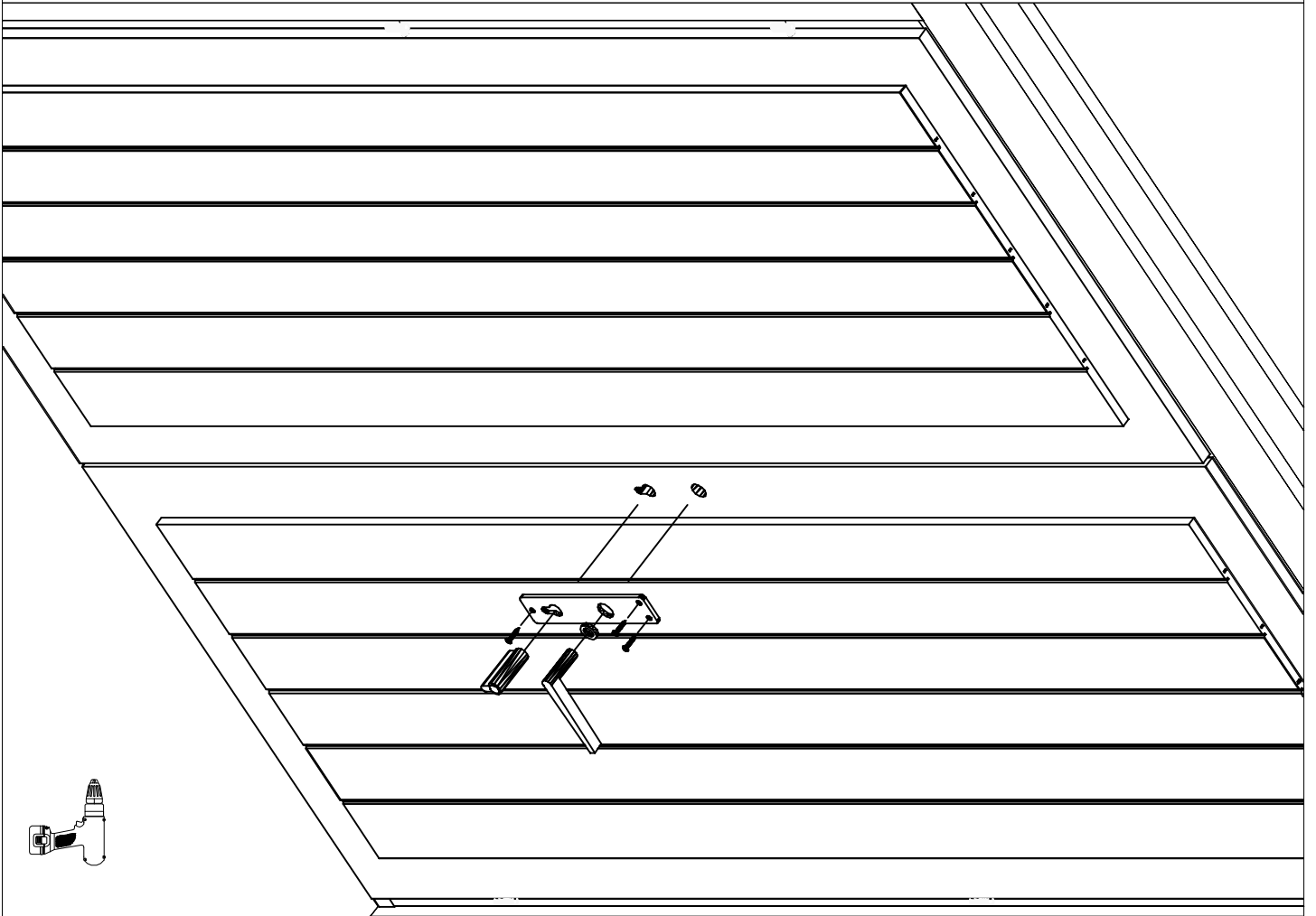
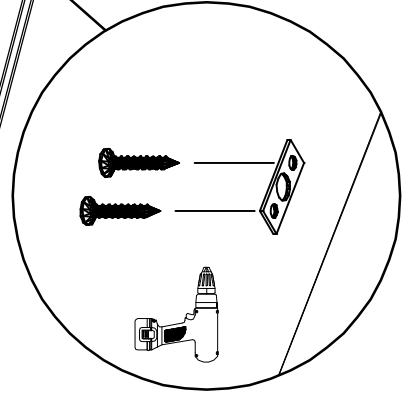
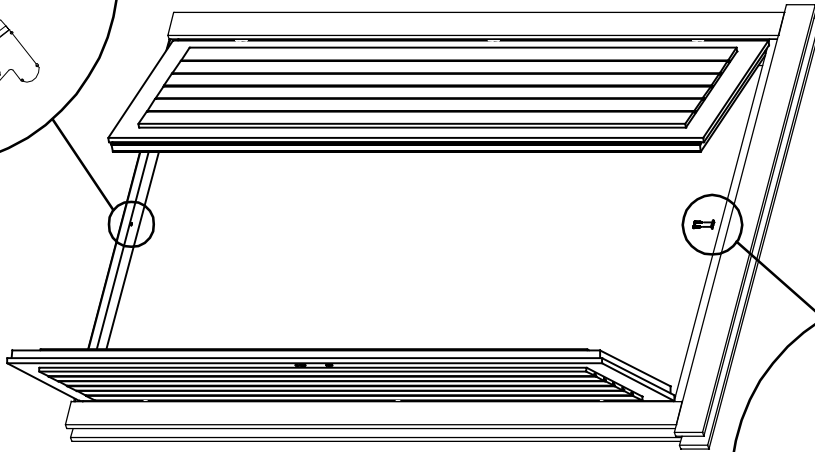
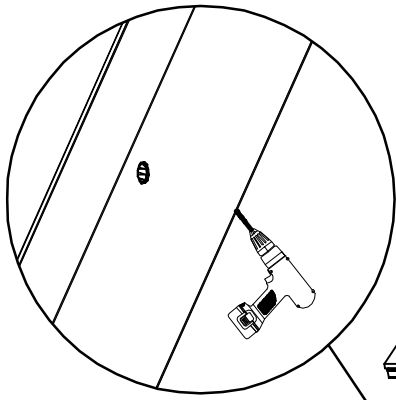

- Giebeldeckleisten
- Gable cover boards
- Dachbretter
- Roof boards
- Giebelbretter
- Gable boards
- Pfetten/Wandbohlen
- Purlins/Wall log

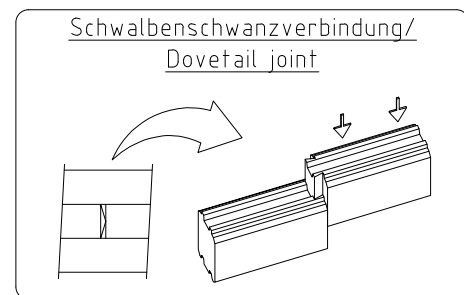
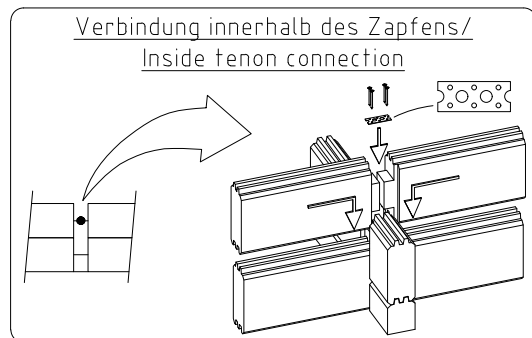
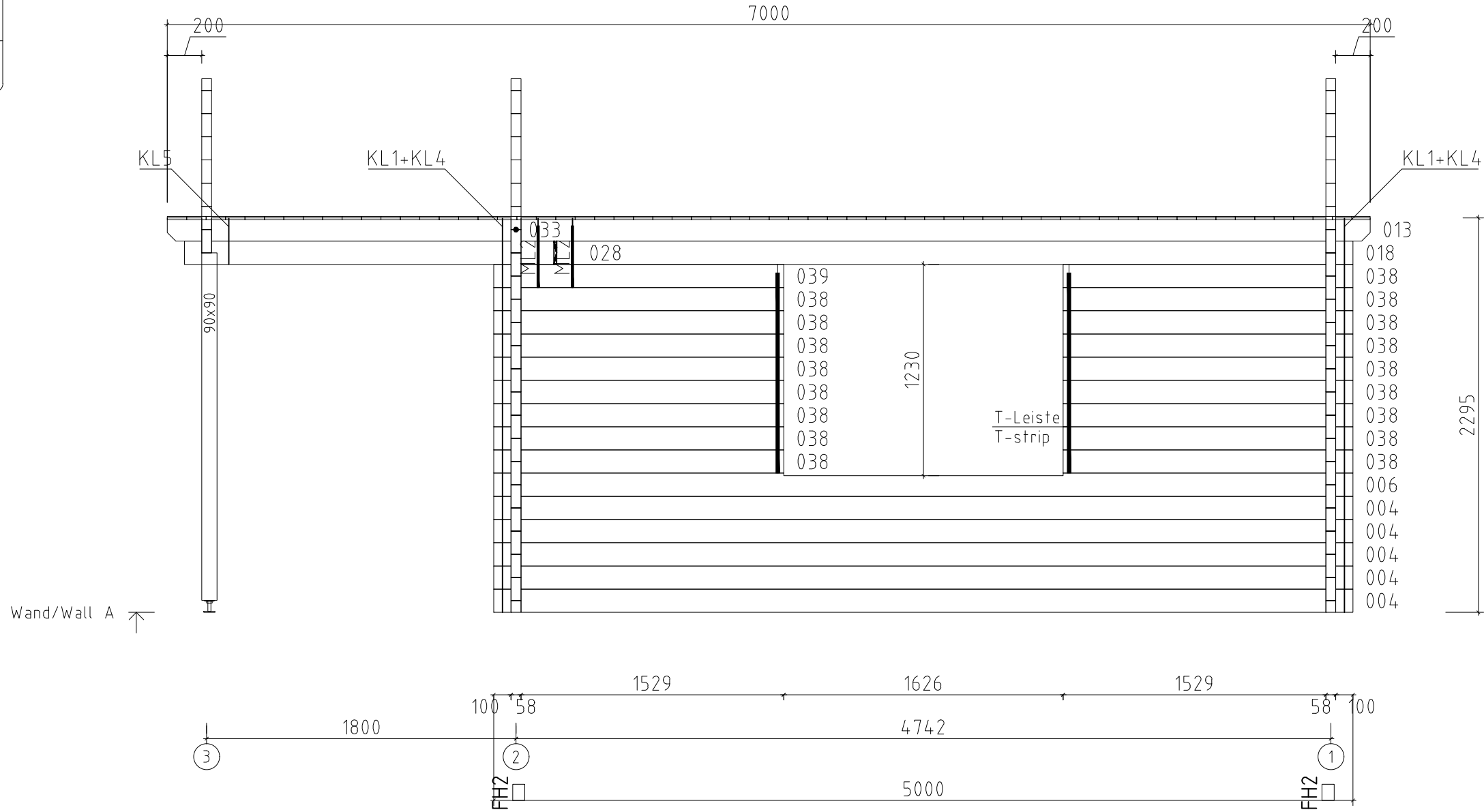

Name	Maasi 500x500+VD; 58	
Name	Karl 500x500+VD; 58	
Zeichnung/Drawing	WAND/WALL A	
Profil/Profile	5.8x13.5	Datum/Date 15.11.2022

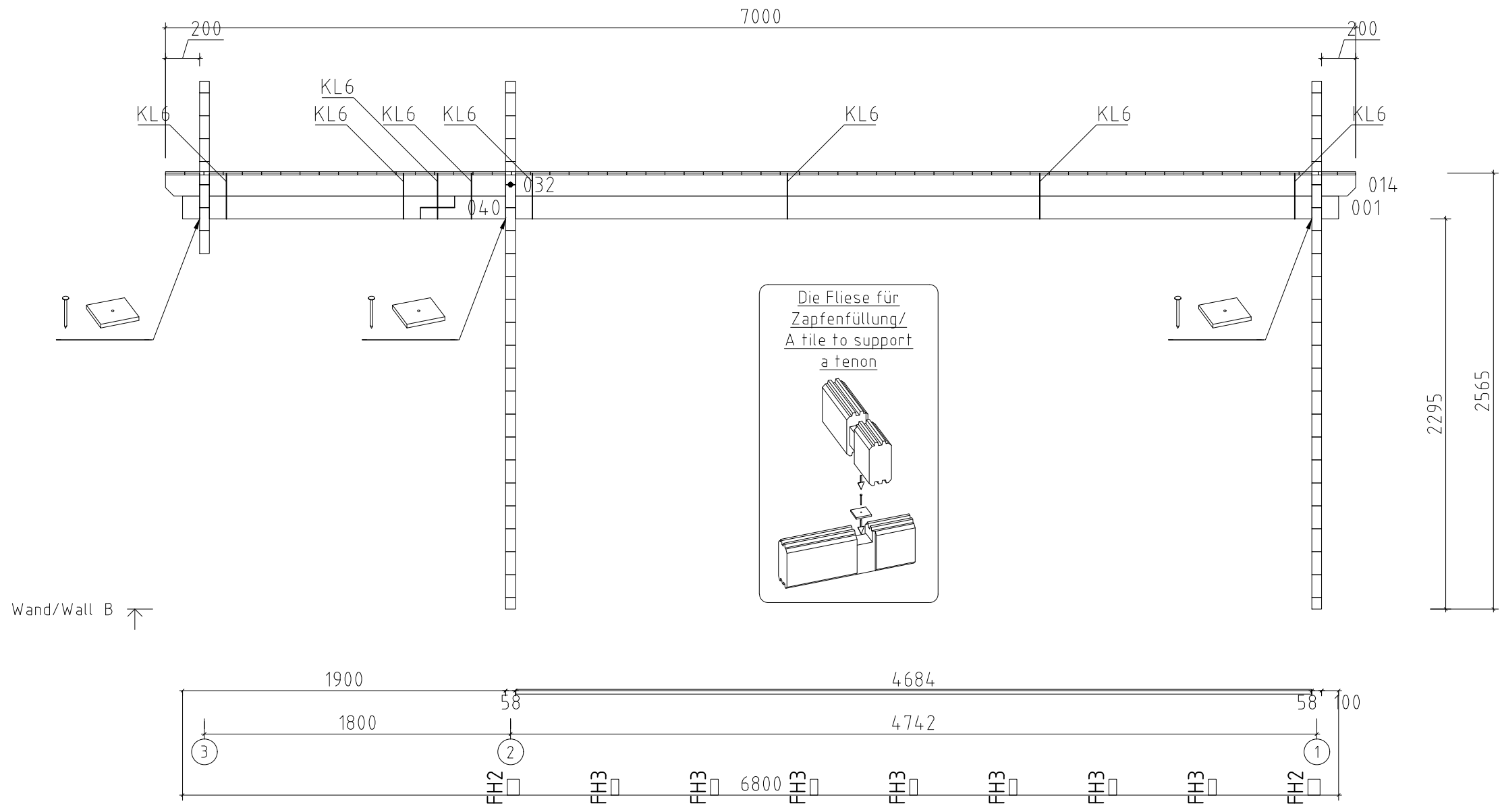

Name	Maasi 500x500+VD; 58	
Name	Karl 500x500+VD; 58	
Zeichnung/Drawing	WAND/WALL B	
Profil/Profile	5.8x13.5	Datum/Date 15.11.2022



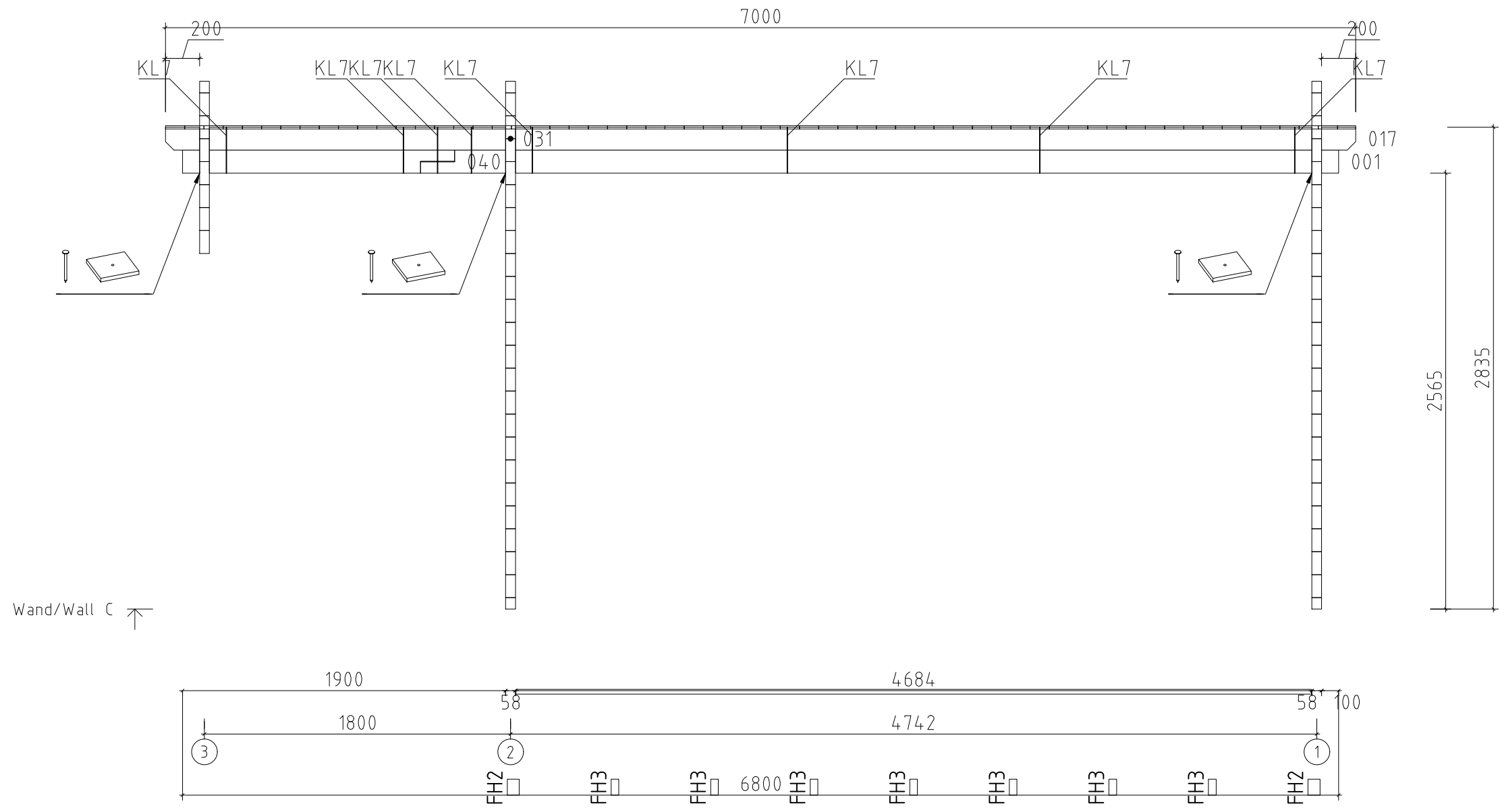

Name	Maasi 500x500+VD; 58		
Name	Karl 500x500+VD; 58		
Zeichnung/Drawing	WAND/WALL C		
Profil/Profile	5.8x13.5	Datum/Date	15.11.2022

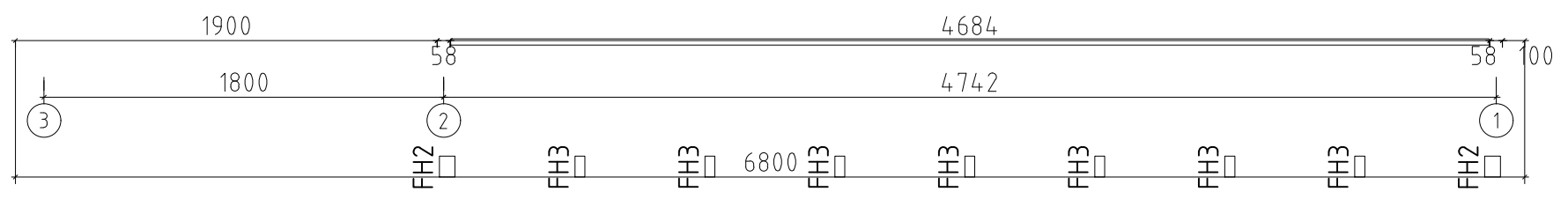
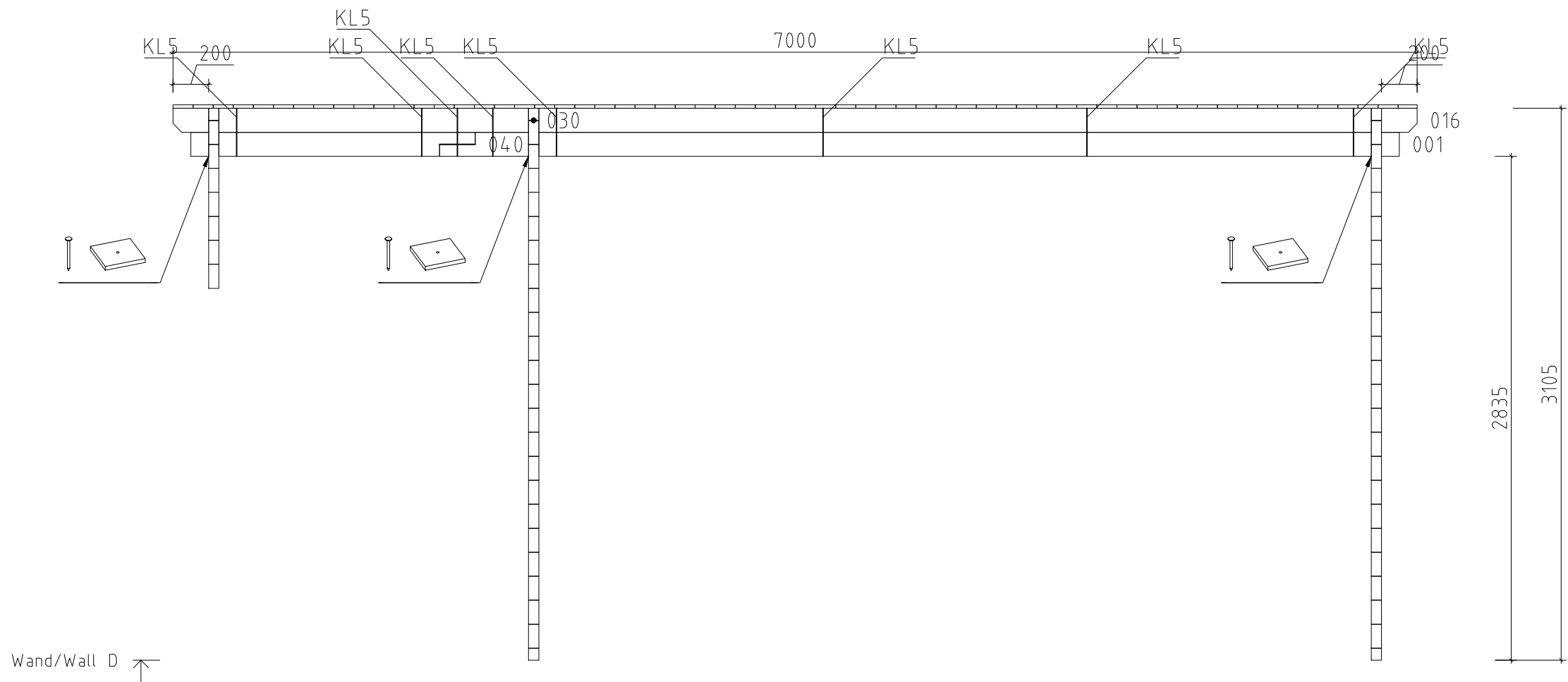

Name	Maasi 500x500+VD; 58		
Name	Karl 500x500+VD; 58		
Zeichnung/Drawing	WAND/WALL D		
Profil/Profile	5.8x13.5	Datum/Date	15.11.2022

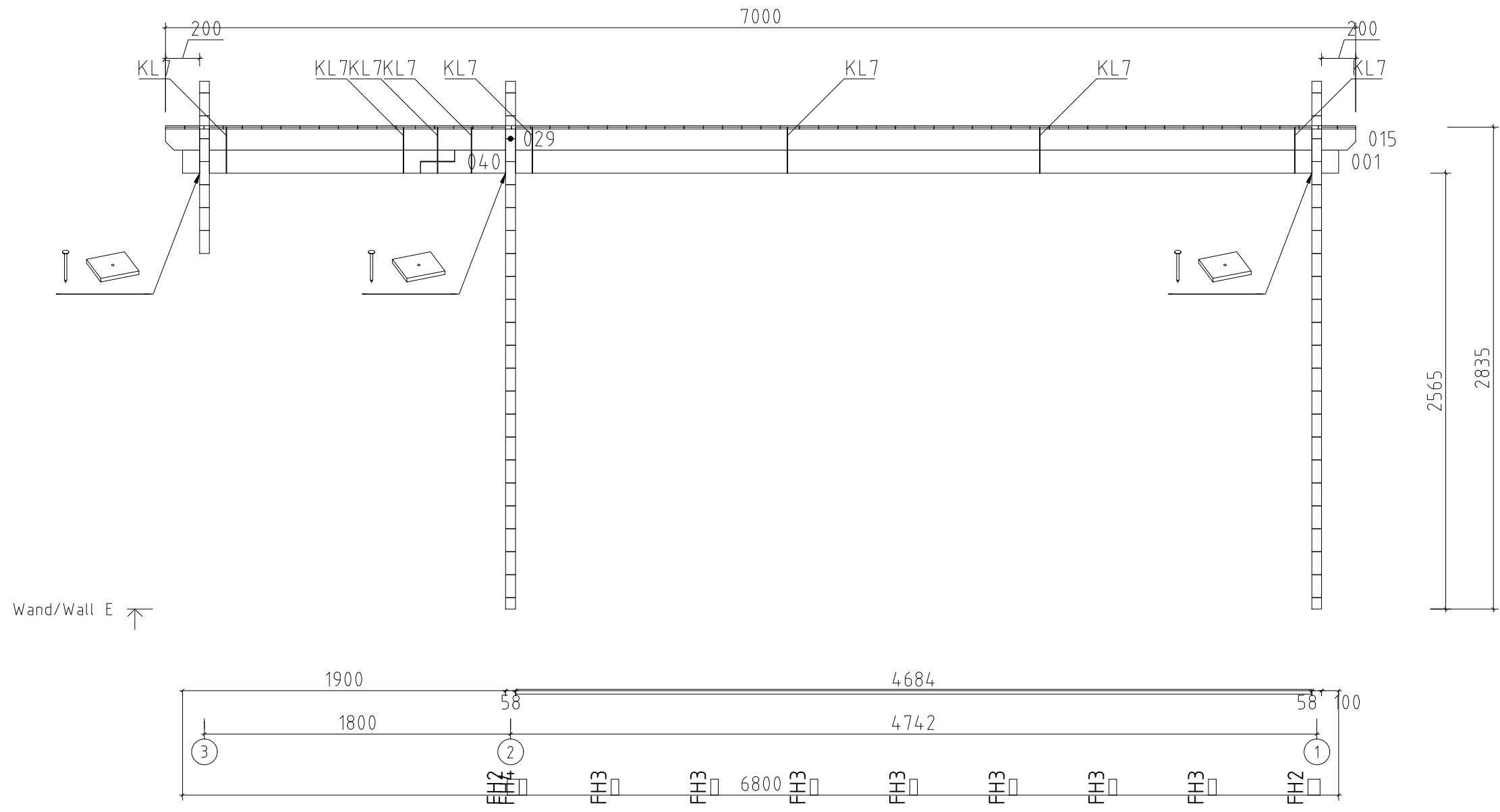

Wand/Wall E ↗

Name	Maasi 500x500+VD; 58		
Name	Karl 500x500+VD; 58		
Zeichnung/Drawing	WAND/WALL E		
Profil/Profile	5.8x13.5	Datum/Date	15.11.2022

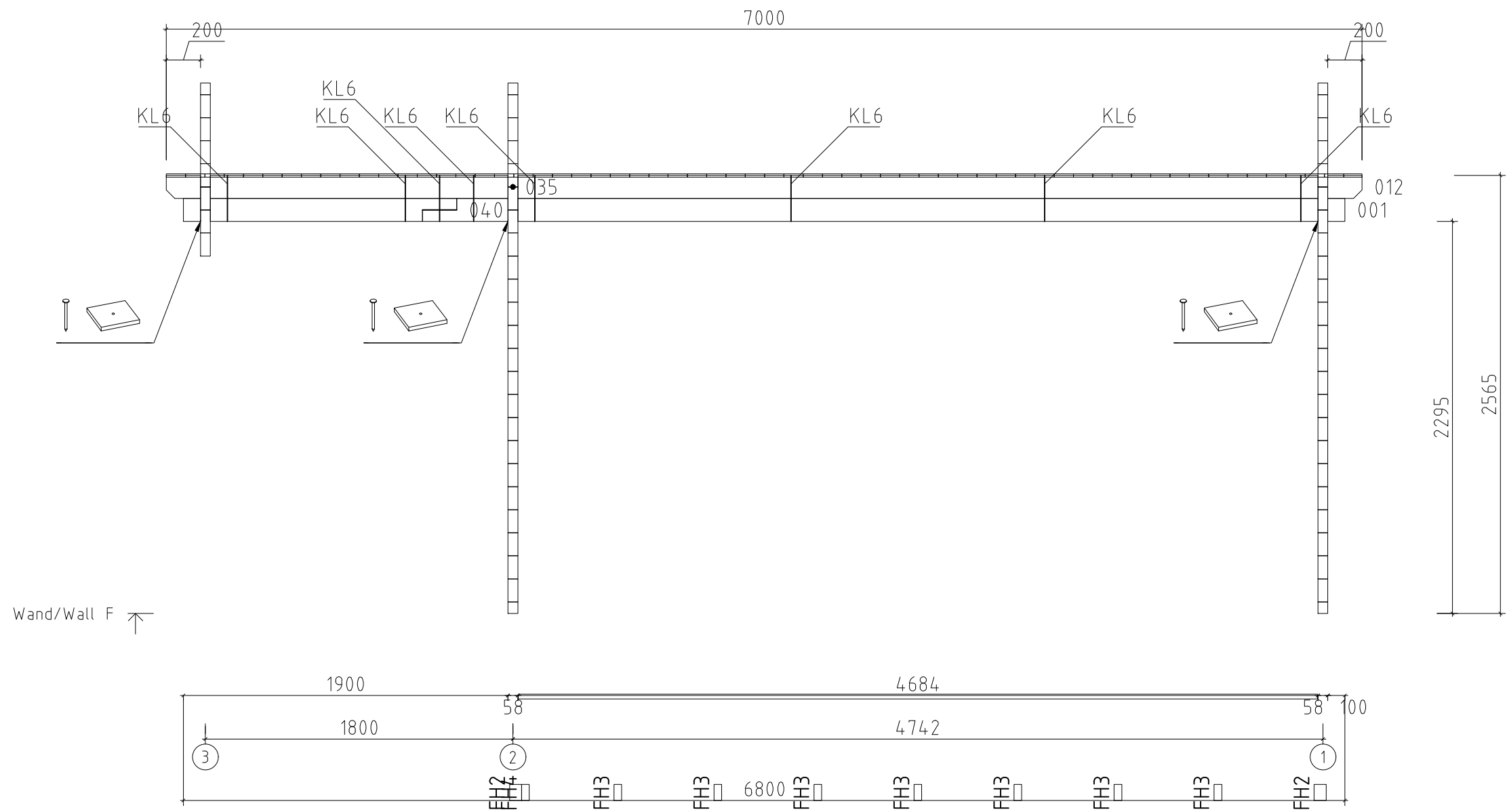

Name	Maasi 500x500+VD; 58		
Name	Karl 500x500+VD; 58		
Zeichnung/Drawing	WAND/WALL F		
Profil/Profile	5.8x13.5	Datum/Date	15.11.2022

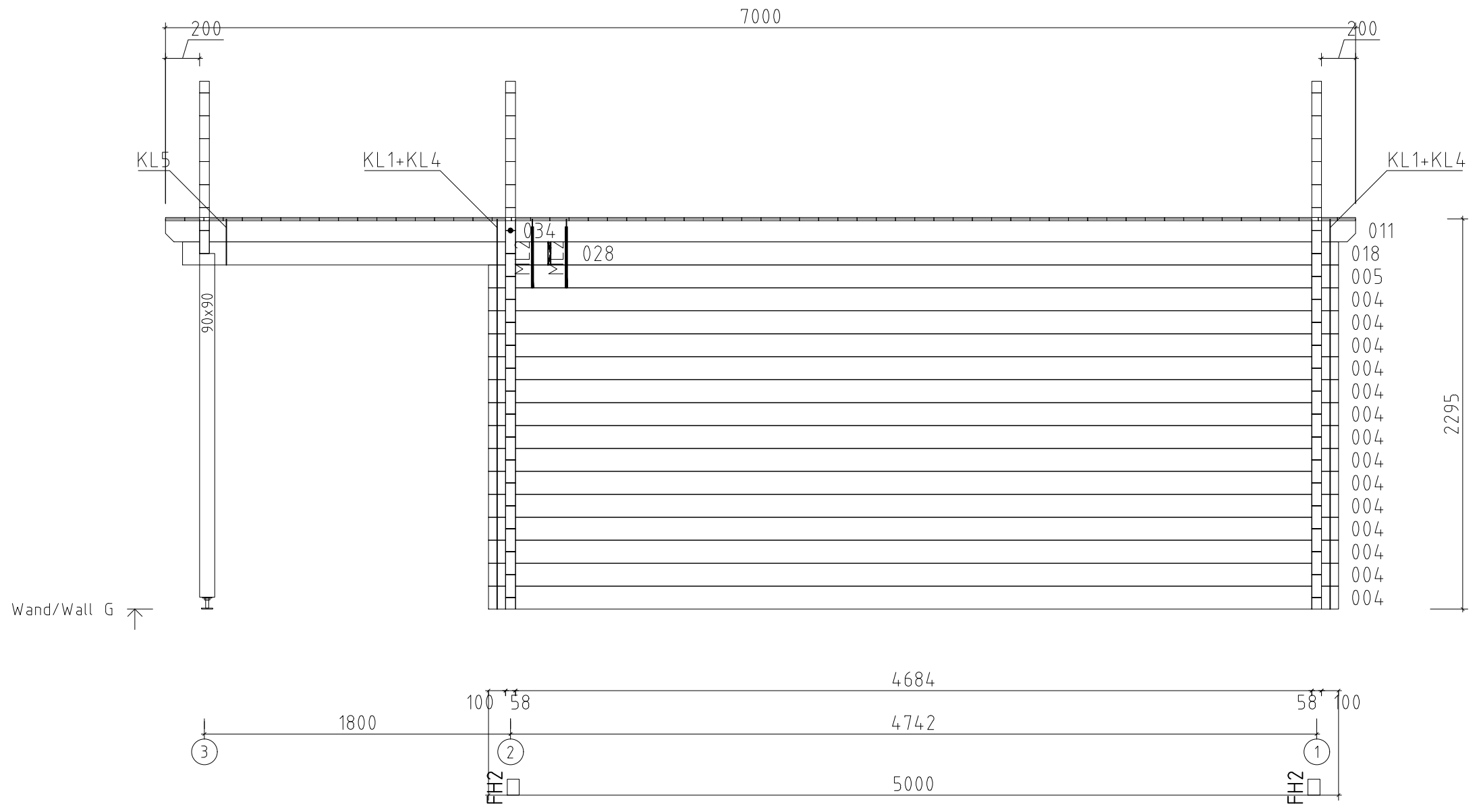

Name	Maasi 500x500+VD; 58		
Name	Karl 500x500+VD; 58		
Zeichnung/Drawing	WAND/WALL G		
Profil/Profile	5.8x13.5	Datum/Date	15.11.2022

Dachbretter	↙
Roof boards	↘
Traufenbretter	↙
Gable boards	↘
Traufenleisten	↙
Eaves strips	↘

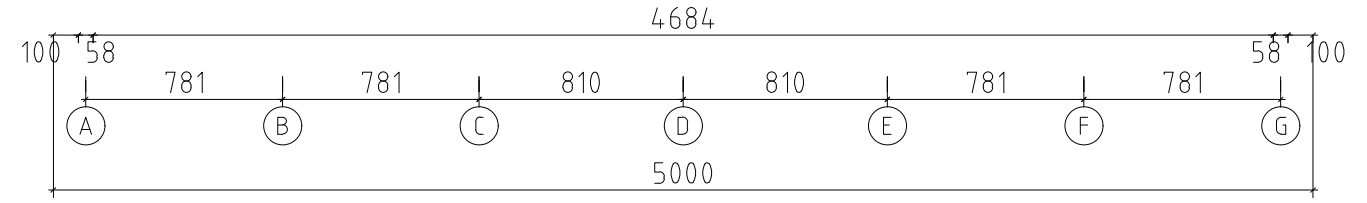
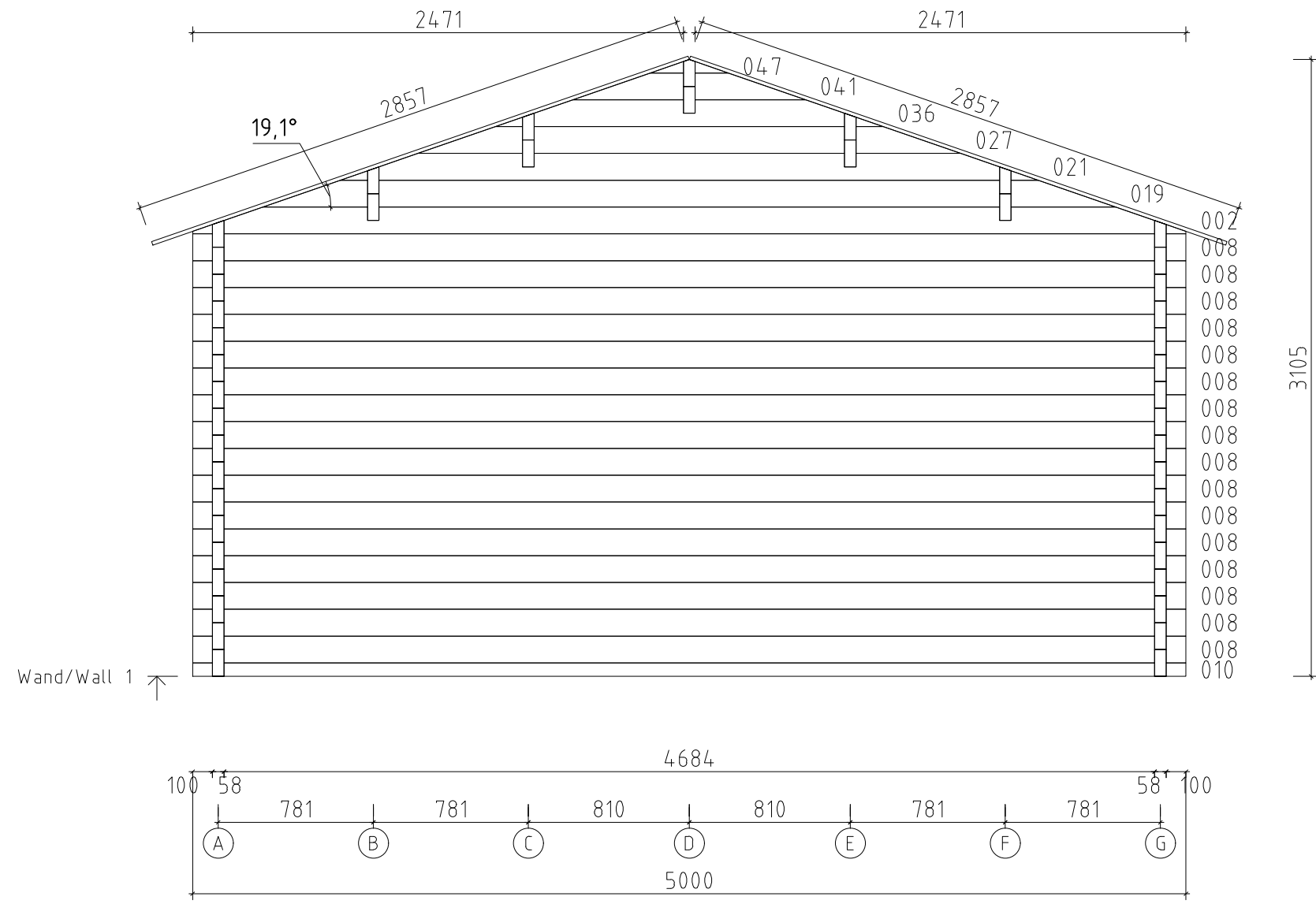

Name	Maasi 500x500+VD; 58	
Name	Karl 500x500+VD; 58	
Zeichnung/Drawing	WAND/WALL 1	
Profil/Profile	5.8x13.5	Datum/Date 15.11.2022

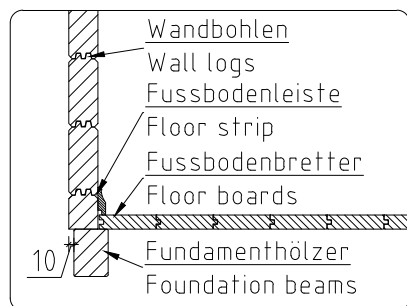
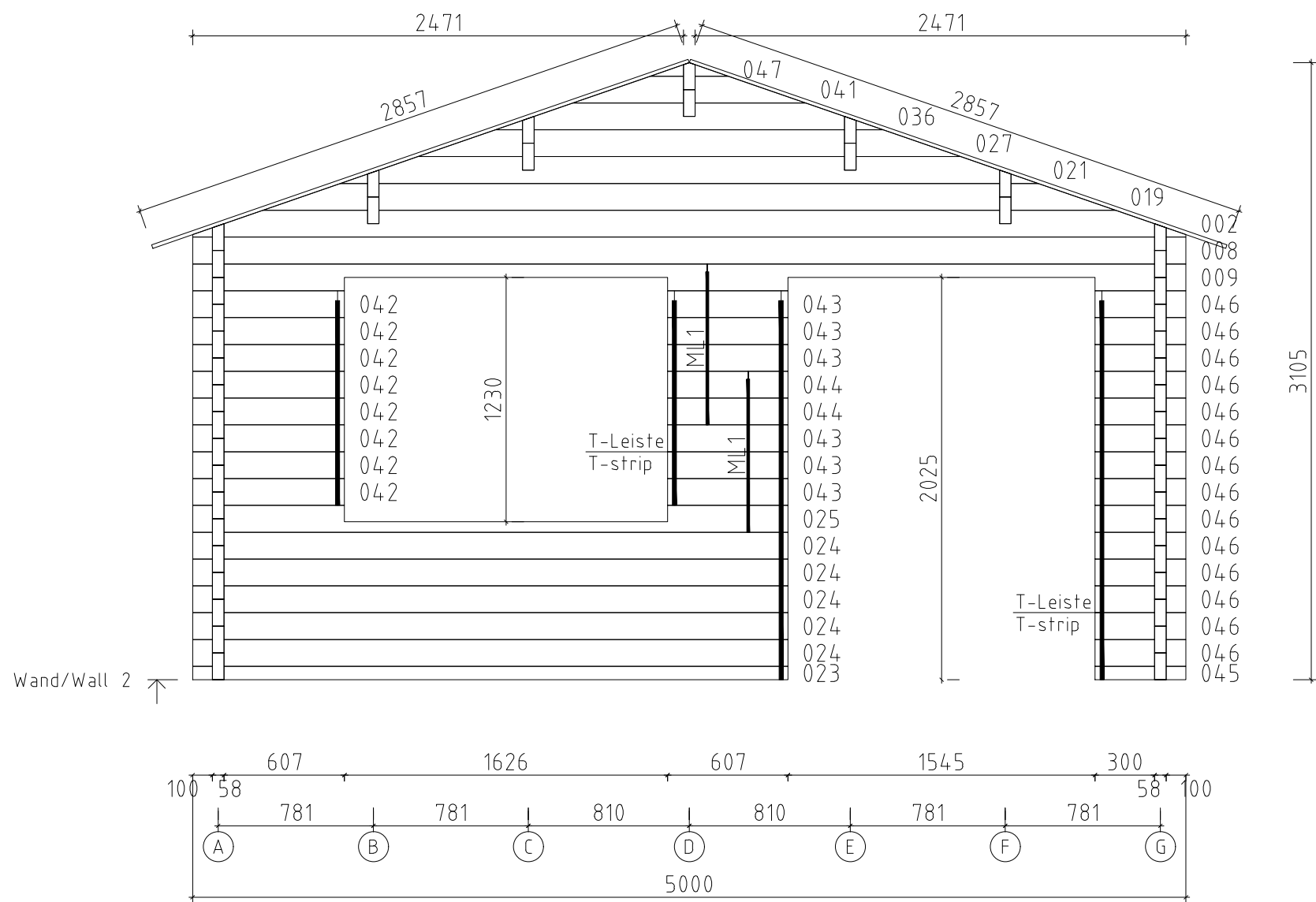

Name	Maasi 500x500+VD; 58	
Name	Karl 500x500+VD; 58	
Zeichnung/Drawing	WAND/WALL 2	
Profil/Profile	5.8x13.5	Datum/Date 15.11.2022

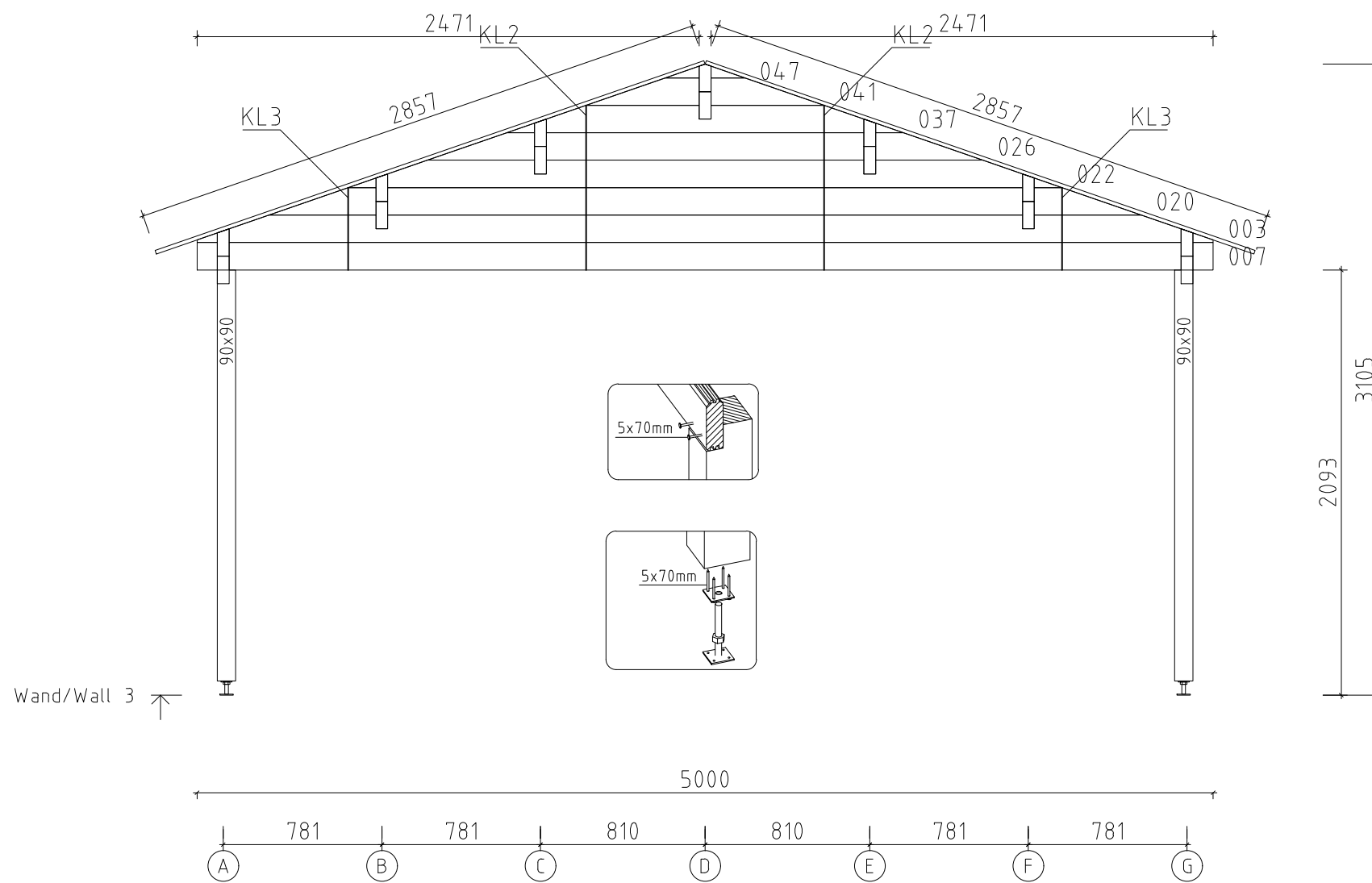

Name	Maasi 500x500+VD; 58		
Name	Karl 500x500+VD; 58		
Zeichnung/Drawing	WAND/WALL 3		
Profil/Profile	5.8x13.5	Datum/Date	15.11.2022