

Name	Stockholm A 535x535+VD 58		
Zeichnung/Drawing	3D		
Profil/Profile	5.8x13.5	Datum/Date	21.05.2018

Giebel Fenster/Gable window
 A68-1
 51x51

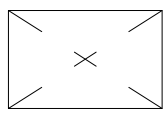
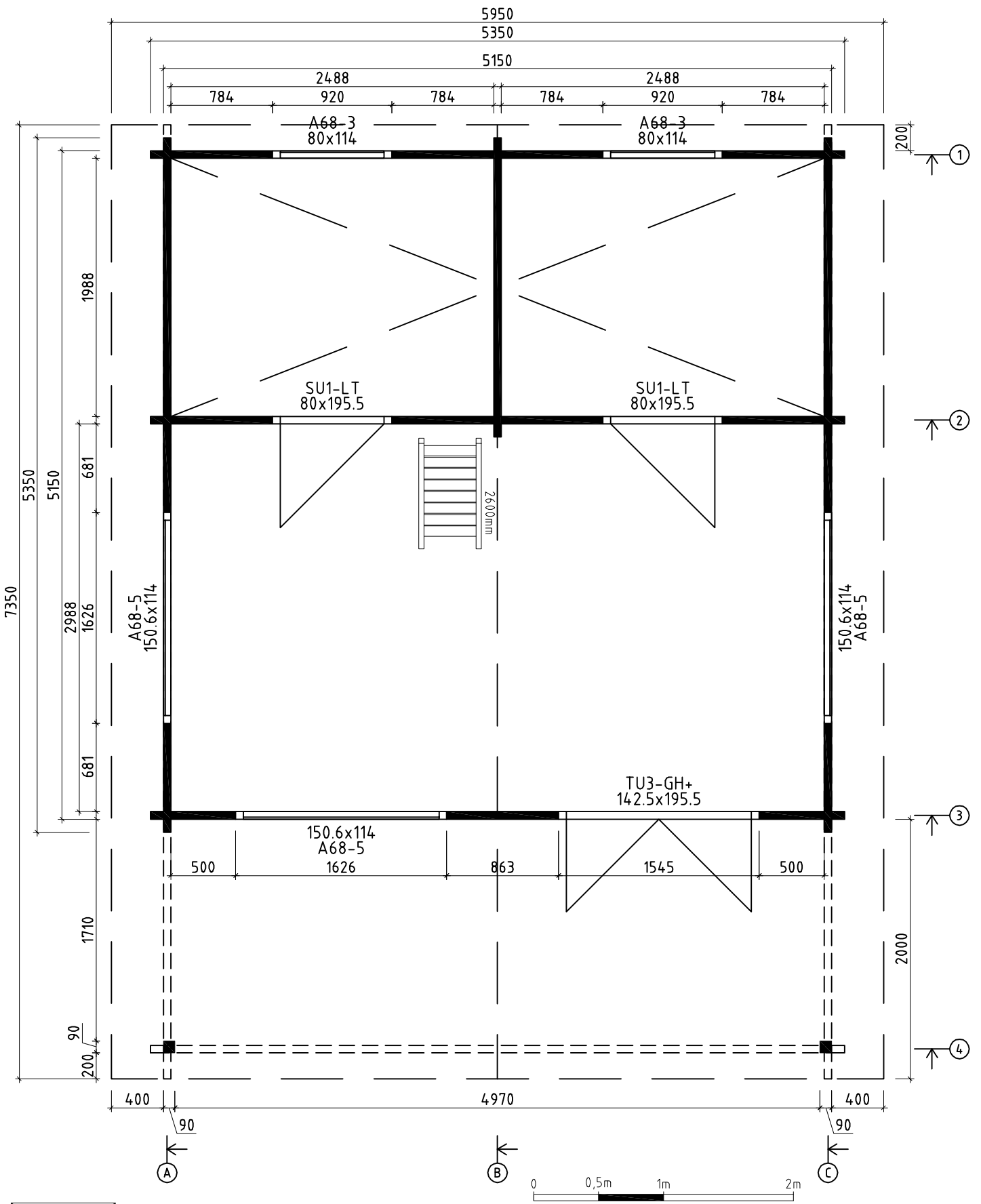

- Schlafboden/sleeping floor

* Fenster und Türen sind mit Sprossen/
 Windows and doors are with muntins

Name		Stockholm A 535x535+VD 58	
Zeichnung/Drawing		Grundplan/Plan	
Maßstab/Scale		1:40	
Profil/Profile		5.8x13.5	
Datum/Date		21.05.2018	
		Druck auf/print on A4	

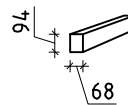
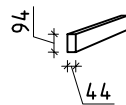
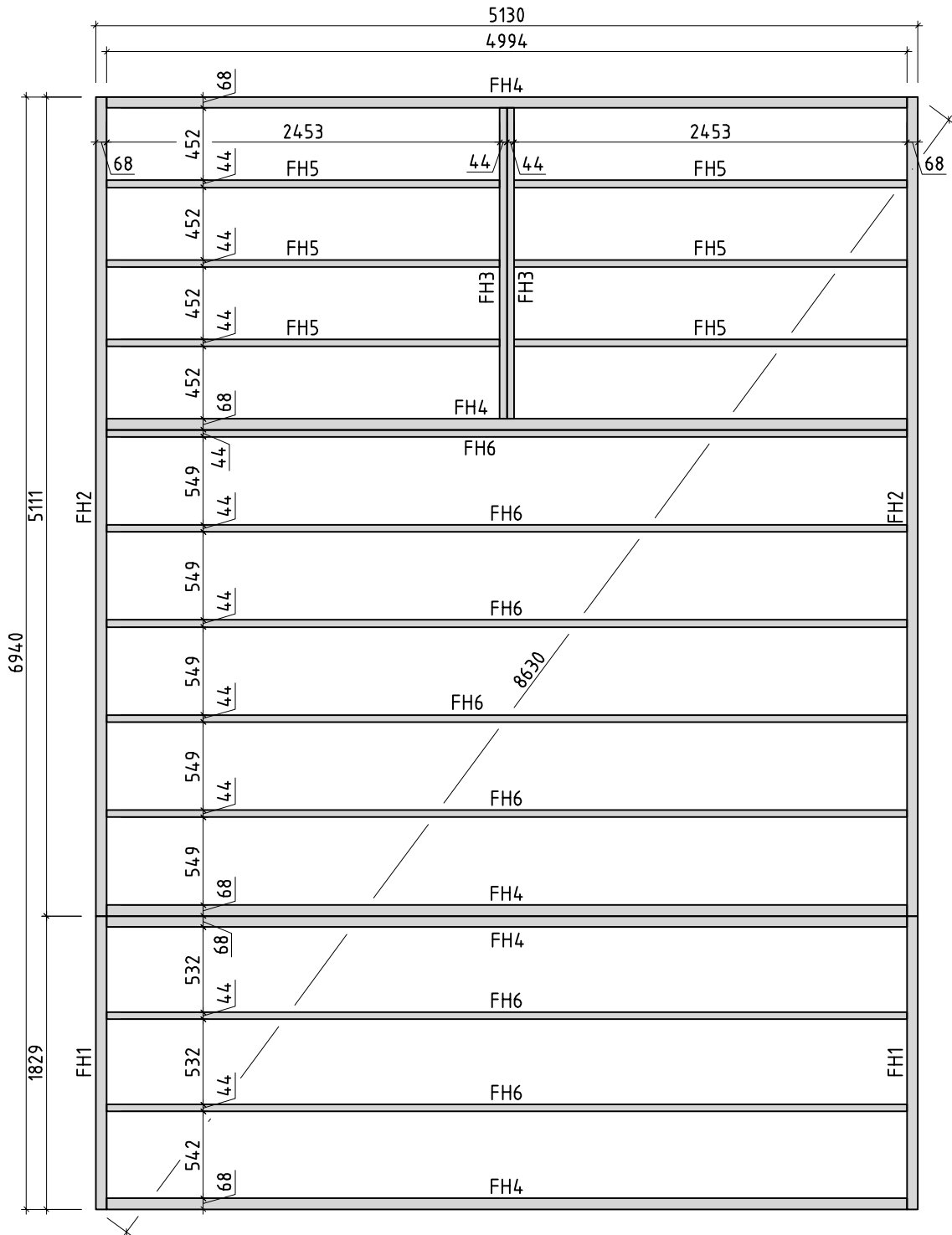

Name				Stockholm A 535x535+VD 58	
Zeichnung/Drawing		Lagerholzplan/Foundation plan		Druck auf/print on A4	
Maßstab/Scale		1:40		Profil/Profile 5.8x13.5	
				Datum/Date 21.05.2018	



✓

✓

✓

✓

✓

✓

✓

✓

✓

✓

✓

✓

✓

✓

✓

✓

✓

Montageanleitung für T-Leisten / Installing the door and window supports / Tenderliistu paigaldusjuhend.

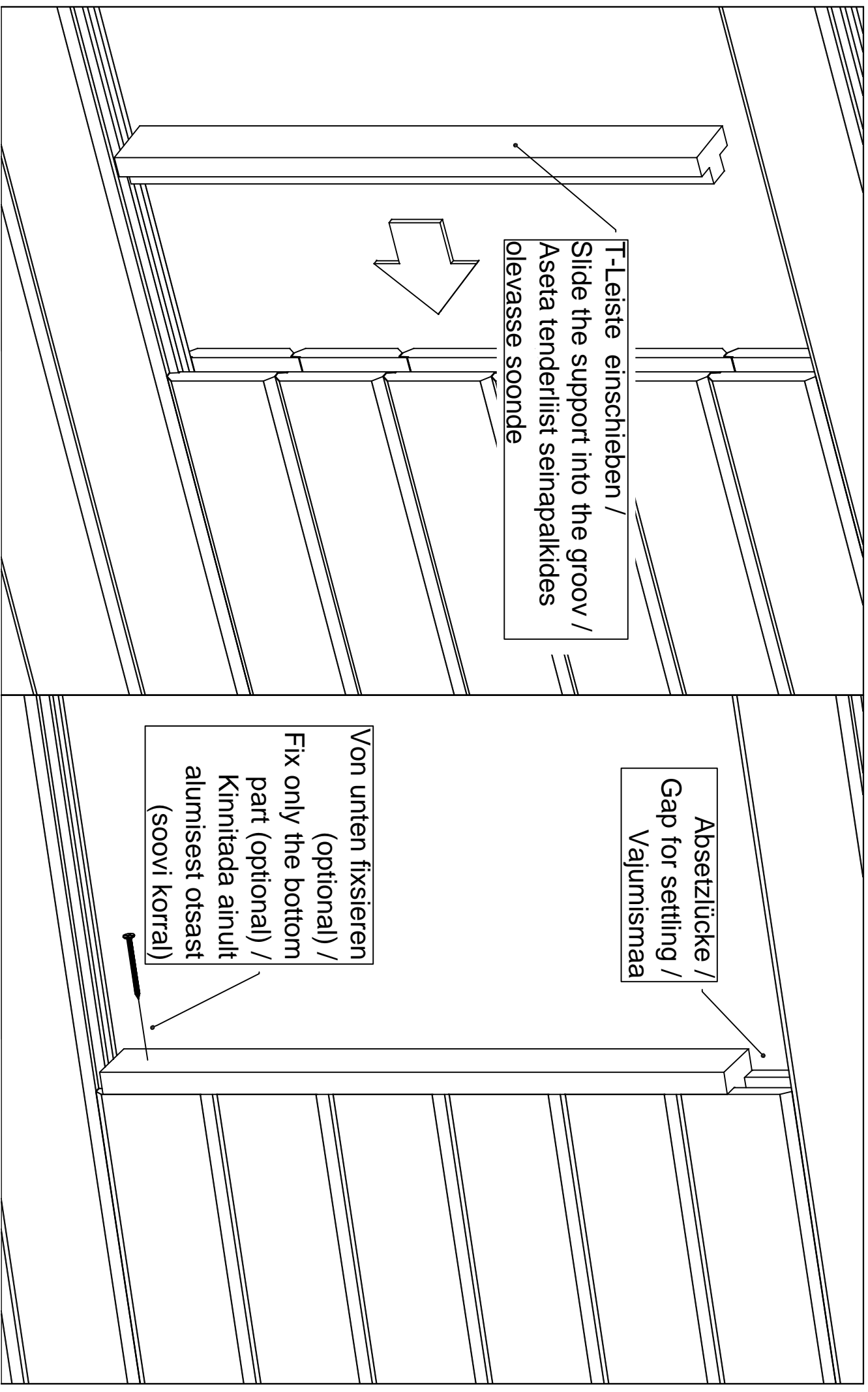

Akna tüüp / Fenster typ / Window type - A68
(GH+ / SH)

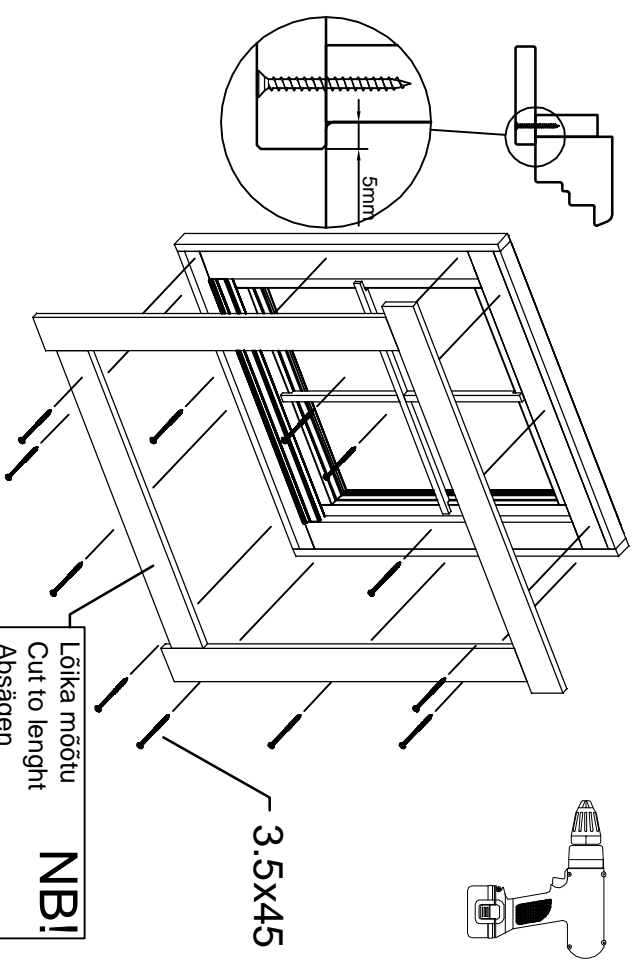
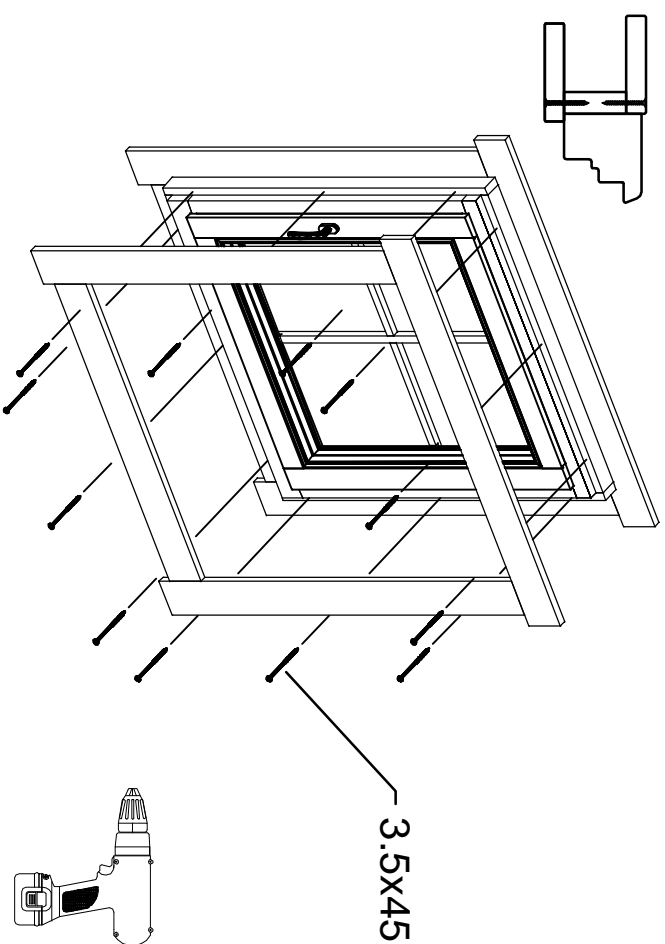
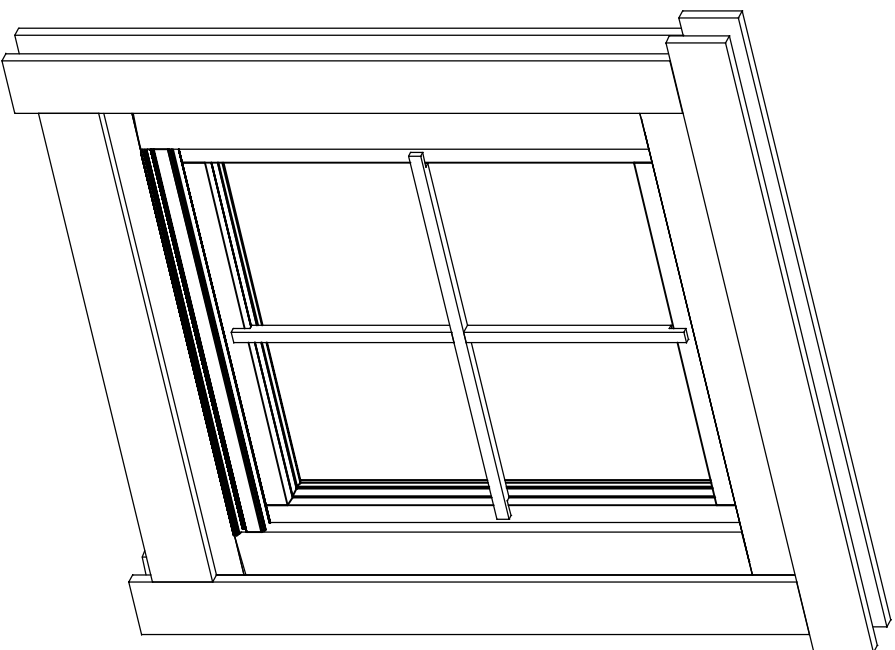

Lõika möötu
Cut to length!
Absägen
- 10-20mm

NB!

Vihmaliist / Rain strip / Wasserleiste

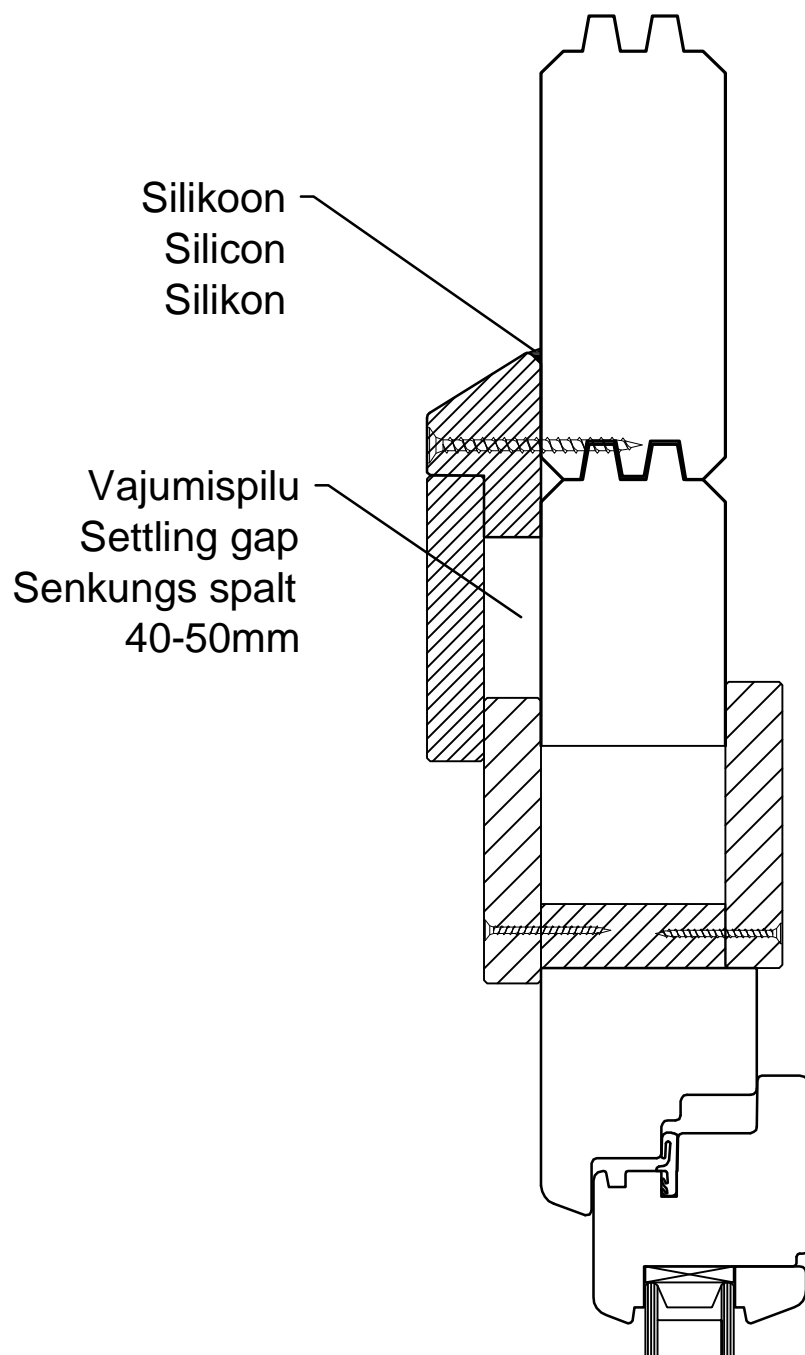

NB!

- Monteerida juhul kui ese on välja toodud maja spetsifikatsioonis!
- Install only if the item is listed in the house specification!
- Nur montieren wenn die Leiste in der Teileliste gezeigt ist!

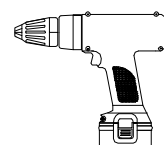

Ukse montaa 0 / Tür montage / Door assembly
(GH+ / SH)

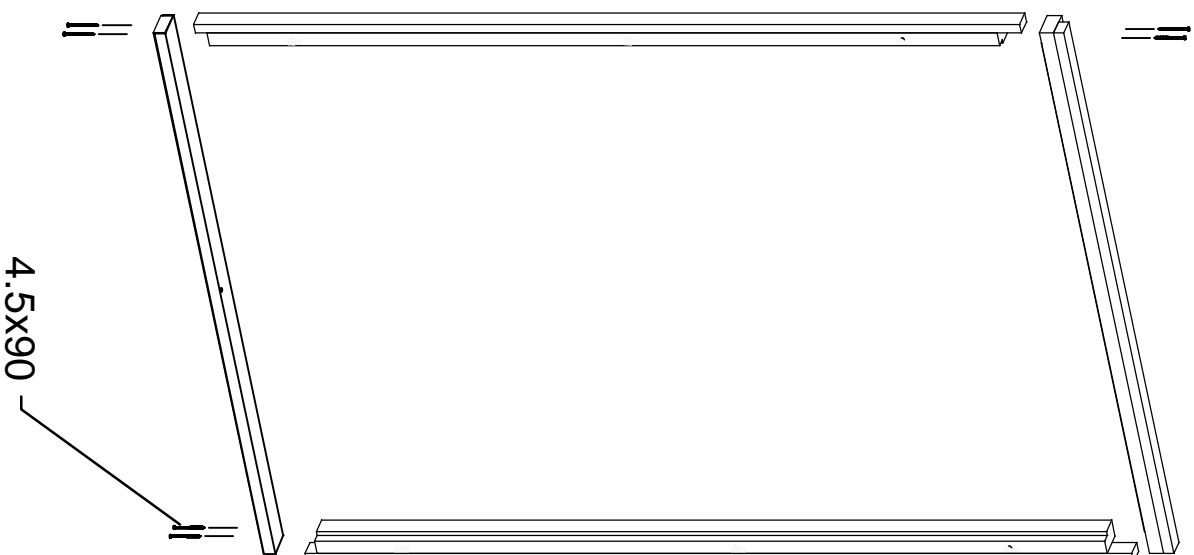
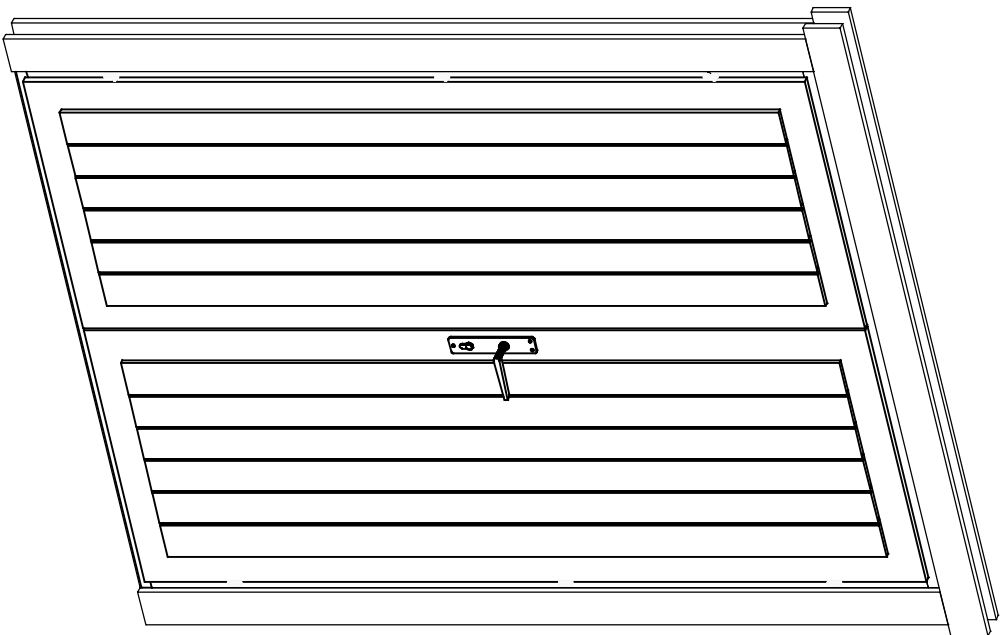

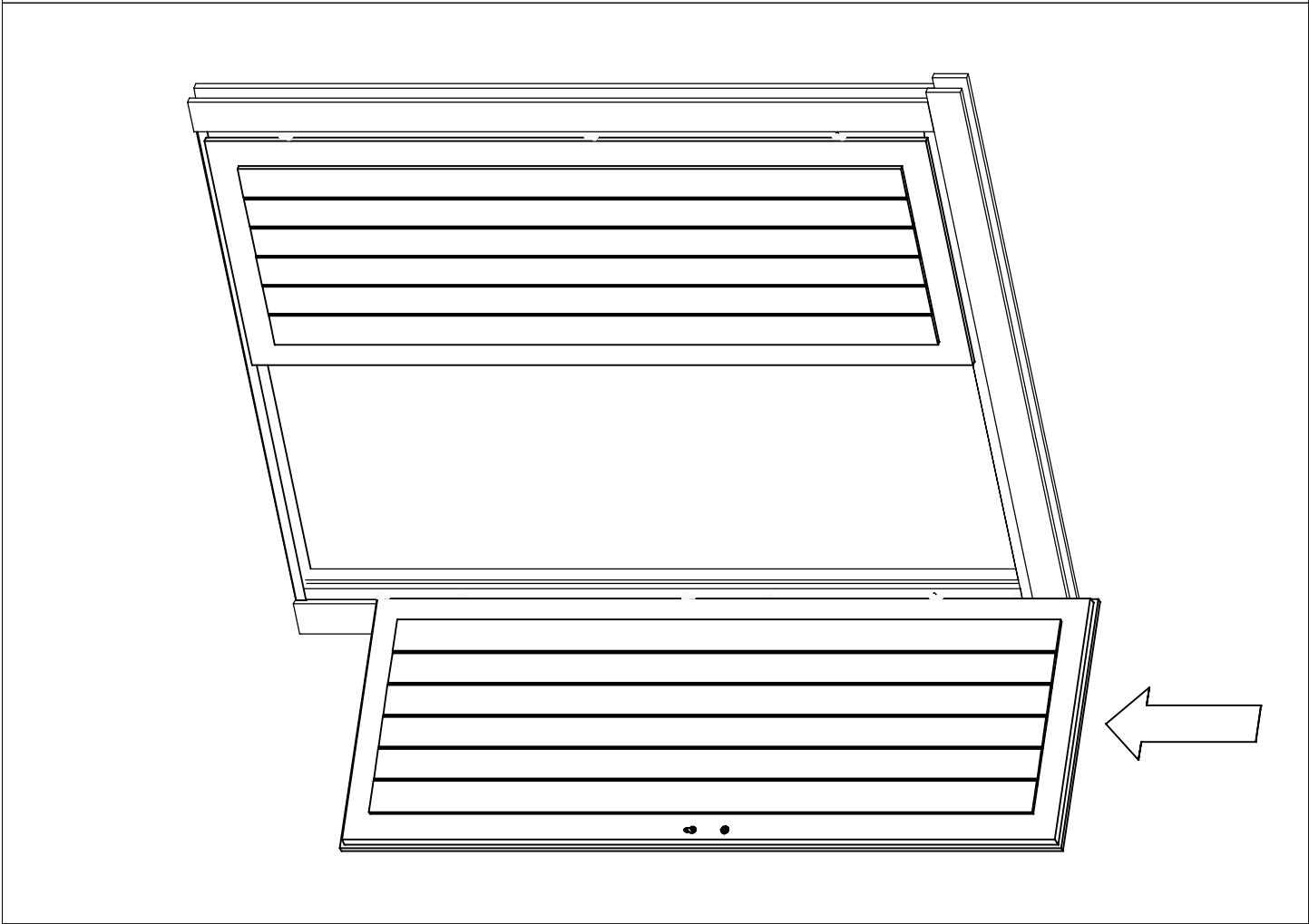
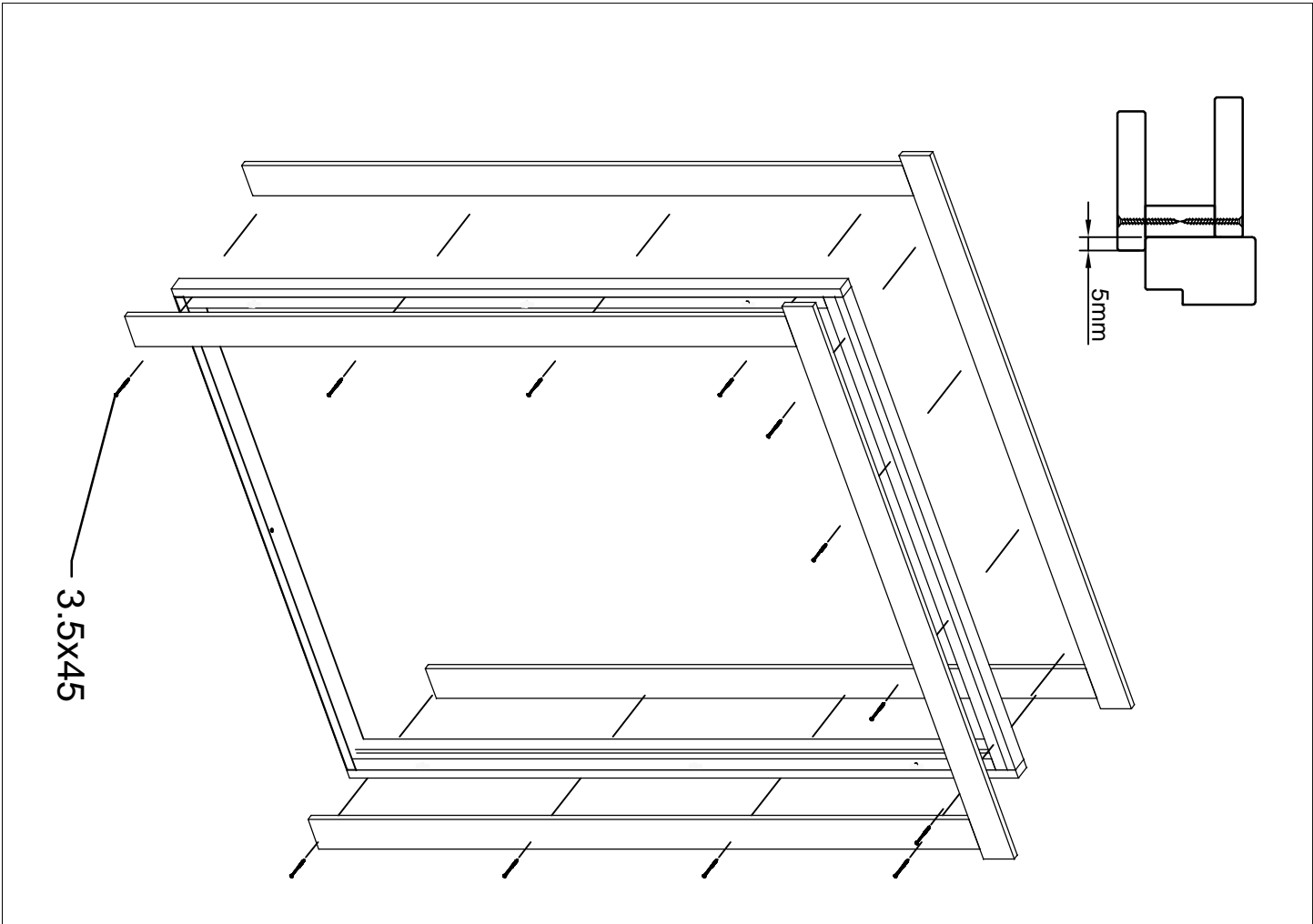

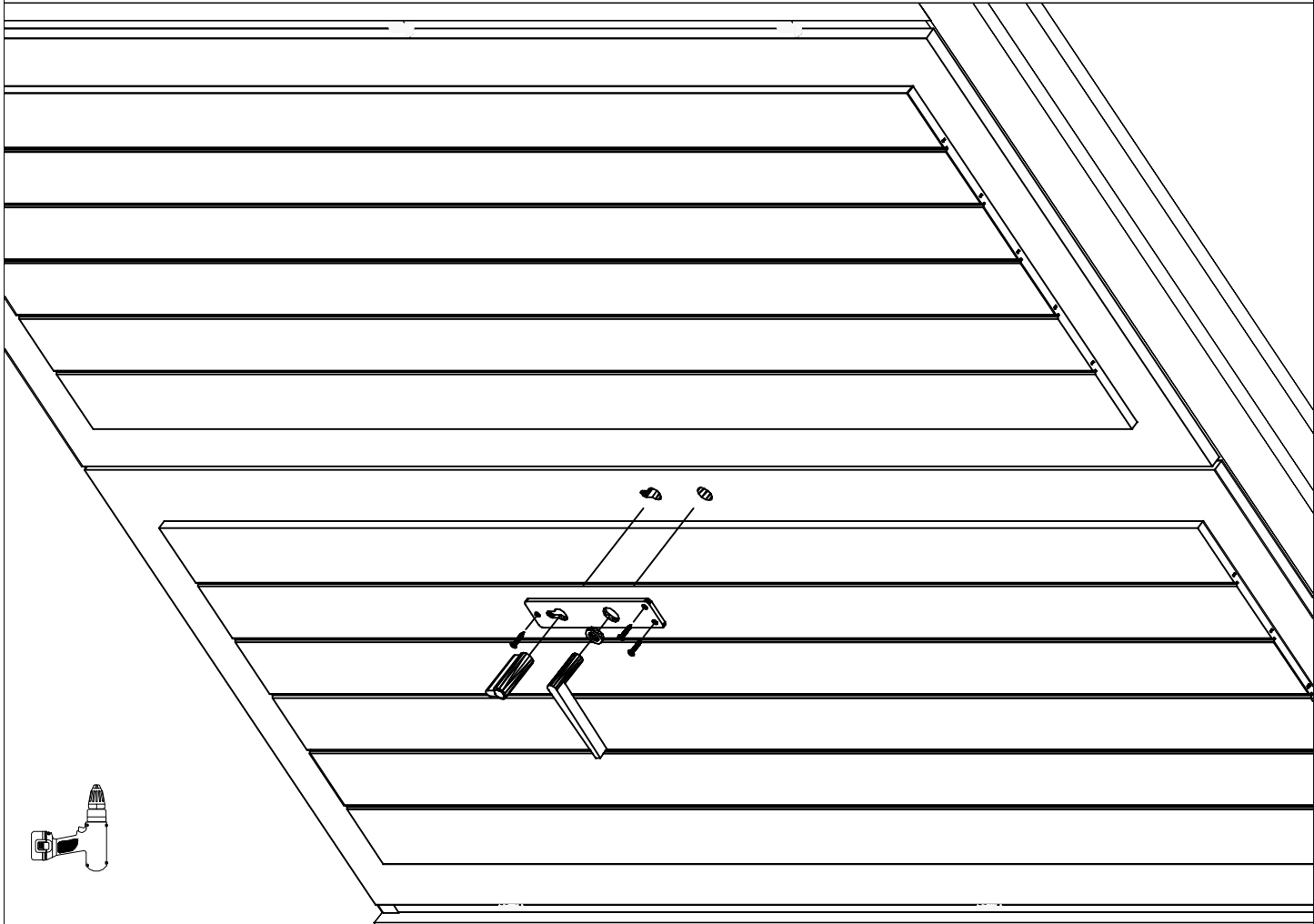
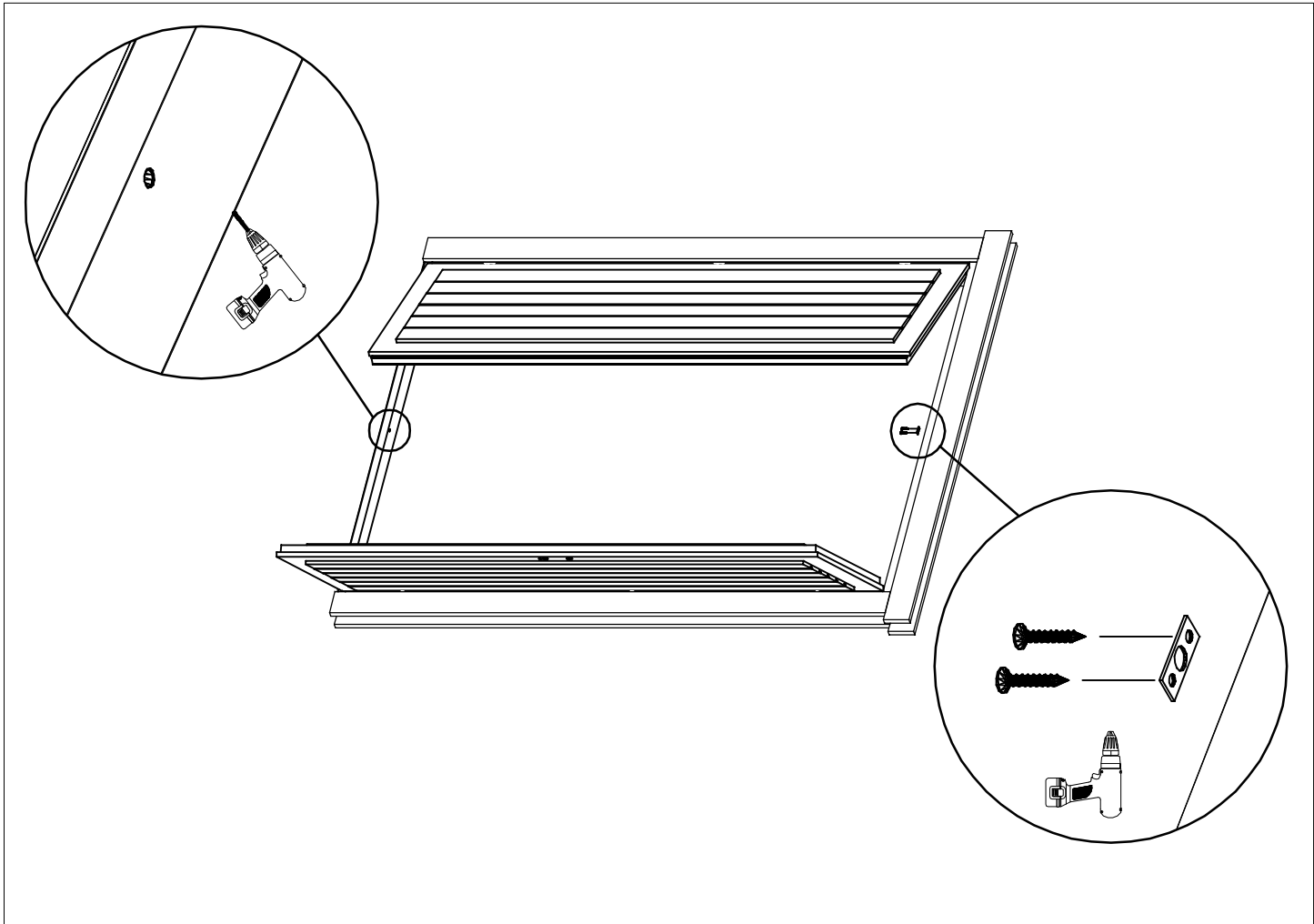

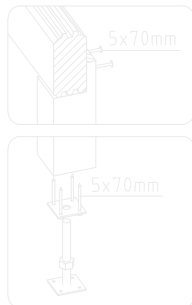
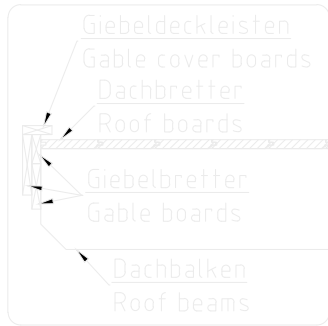

Wand/Wall A

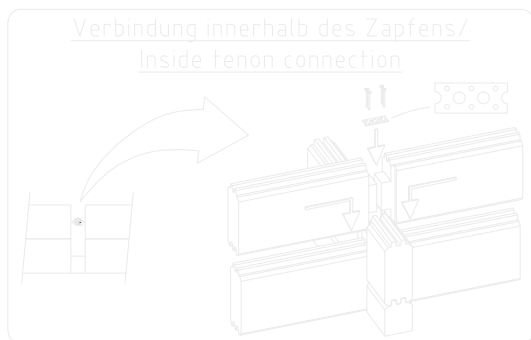
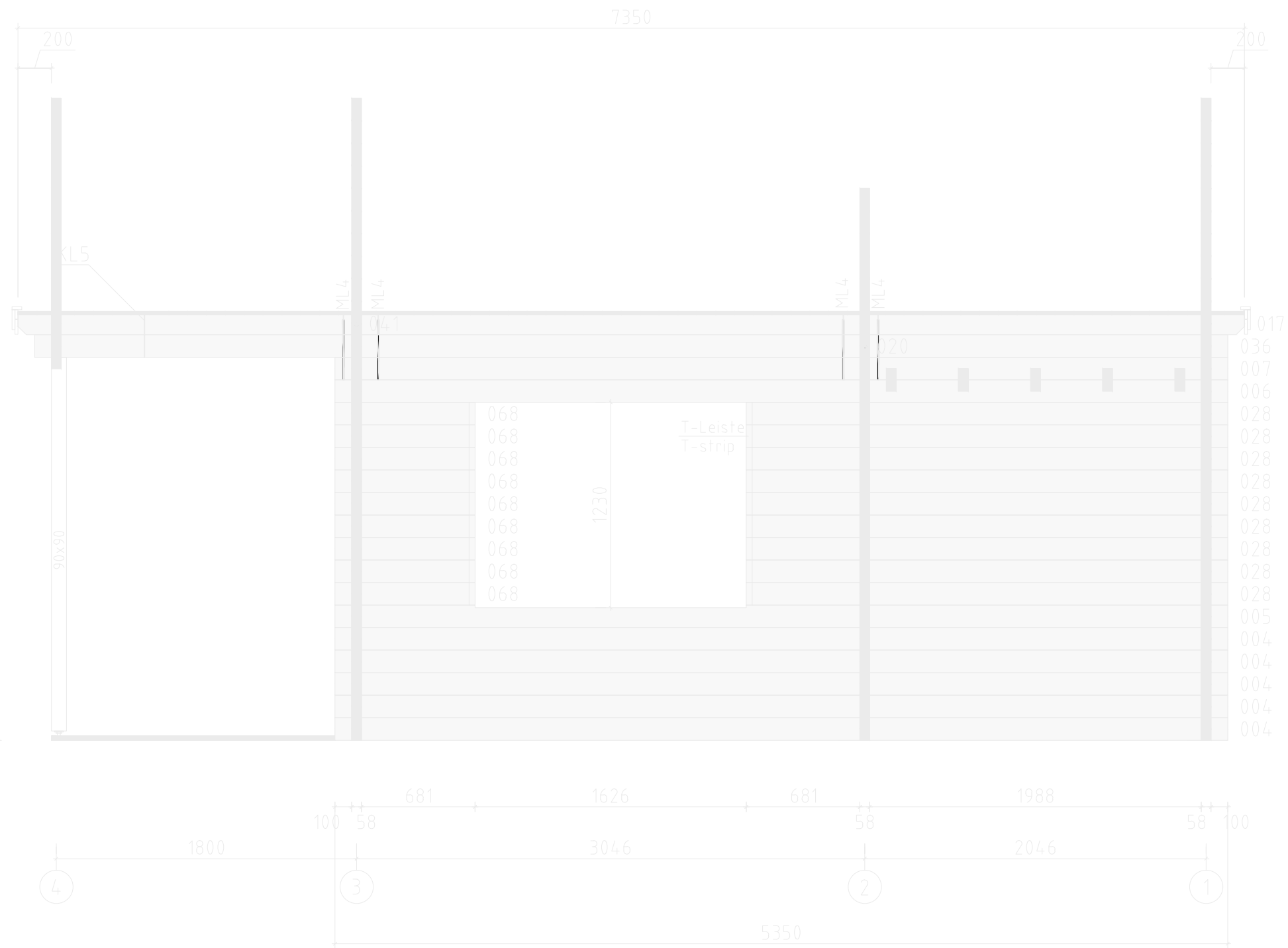

Name	Stockholm A 535x535+VD 58		
Zeichnung/Drawing	WAND/WALL A	Druck auf/print on	A4
Maßstab/Scale	1:40	Profil/Profile	5.8x13.5
		Datum/Date	21.05.2018

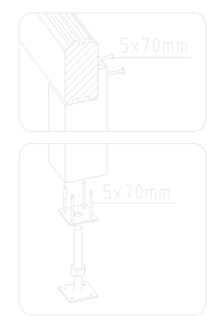
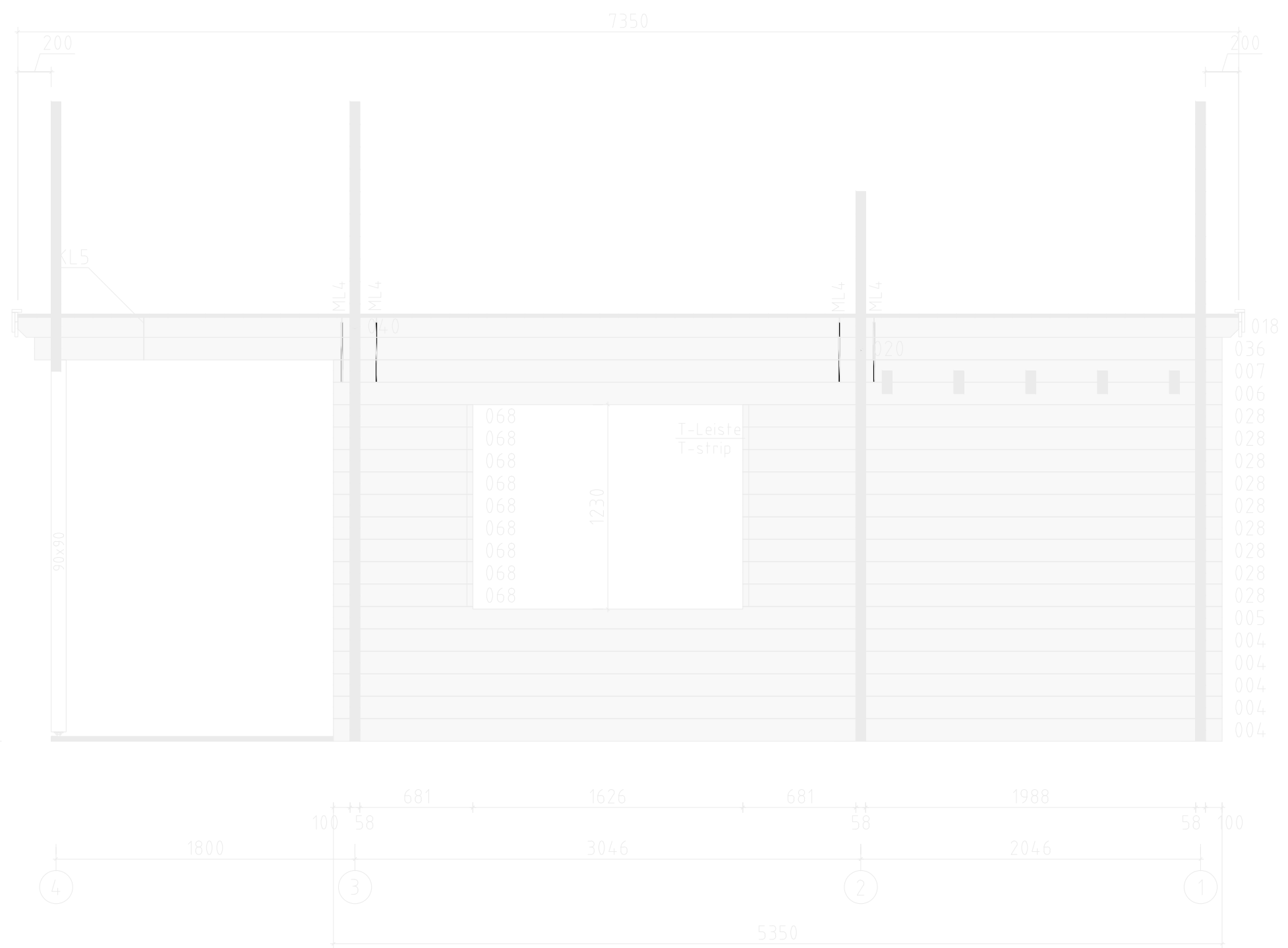

Wand/Wall C ↑

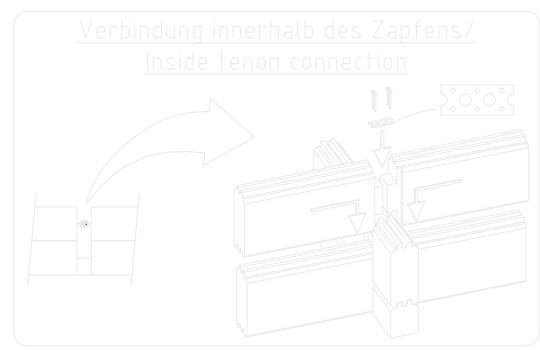

Name	Stockholm A 535x535+VD 58		
Zeichnung/Drawing	WAND/WALL C	Druck auf/print on	A4
Maßstab/Scale	1:40	Profil/Profile	5.8x13.5
		Datum/Date	21.05.2018

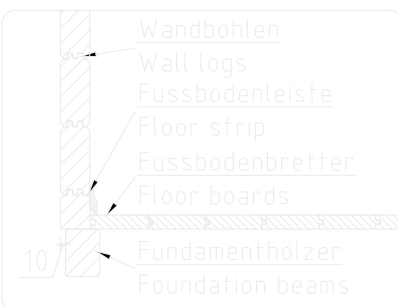
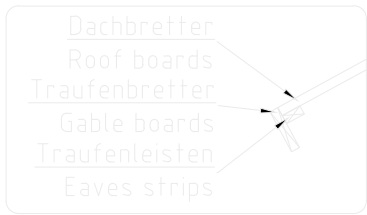

Name	Stockholm A 535x535+VD 58		
Zeichnung/Drawing	WAND/WALL 1	Druck auf/print on	A4
Maßstab/Scale	1:40	Profil/Profile	5.8x13.5
		Datum/Date	21.05.2018

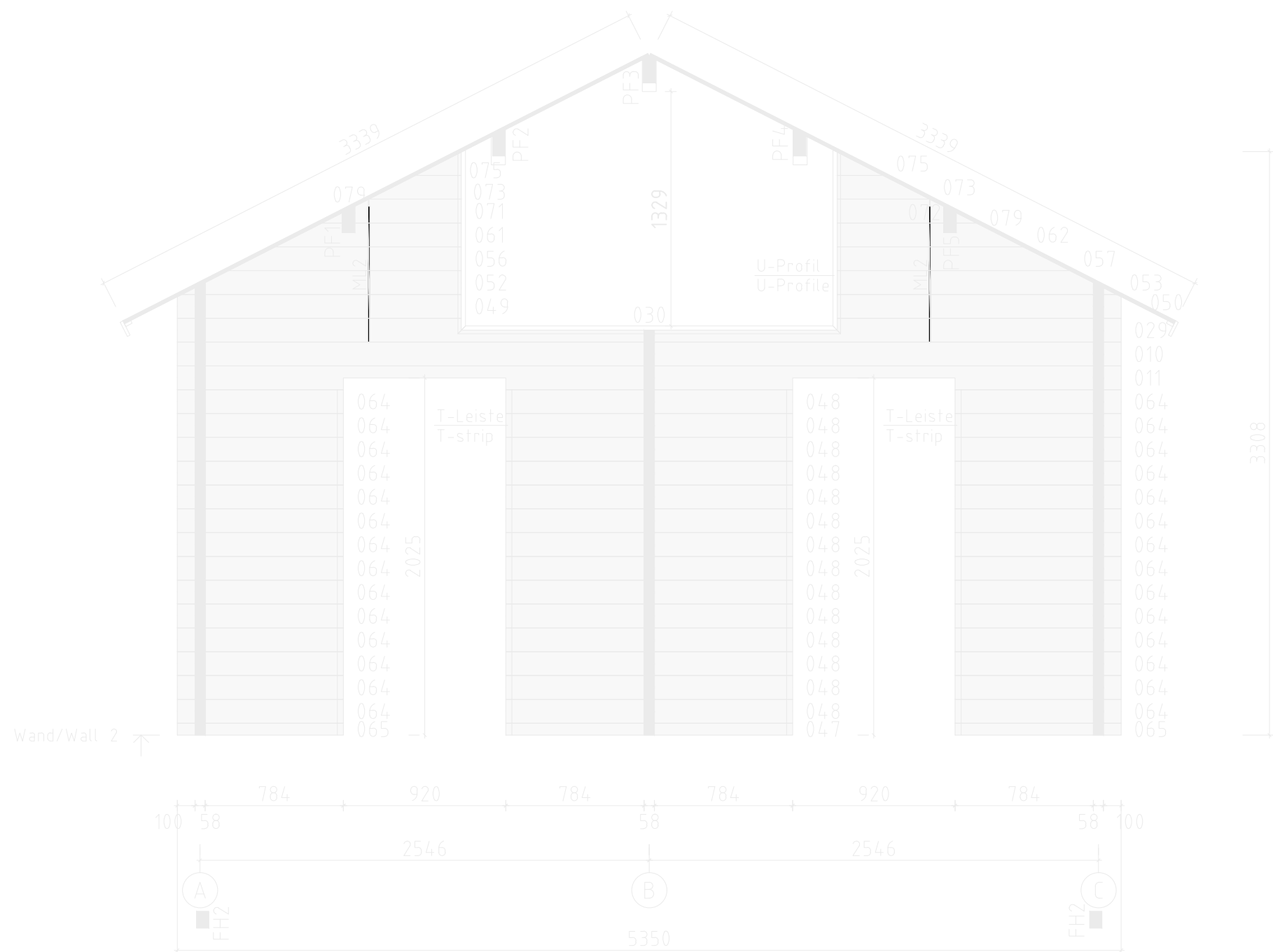

Name	Stockholm A 535x535+VD 58		
Zeichnung/Drawing	WAND/WALL 2	Druck auf/print on	A4
Maßstab/Scale	1:40	Profil/Profile	5.8x13.5
		Datum/Date	21.05.2018

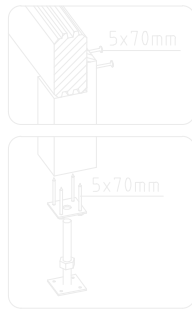
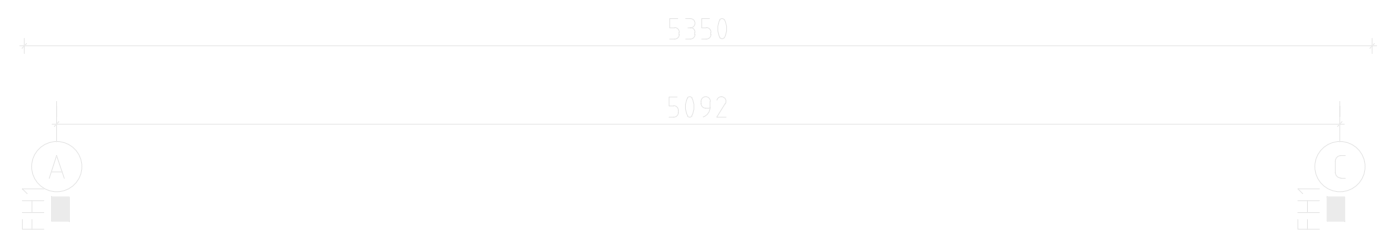

Wand/Wall 4



Name	Stockholm A 535x535+VD 58		
Zeichnung/Drawing	WAND/WALL 4	Druck auf/print on	A4
Maßstab/Scale	1:40	Profil/Profile	5.8x13.5
		Datum/Date	21.05.2018