

Name	Malaga 2 420x720_58		
Zeichnung/Drawing	3D		
Profil/Profile	5.8x13.5	Datum/Date	11.04.2022

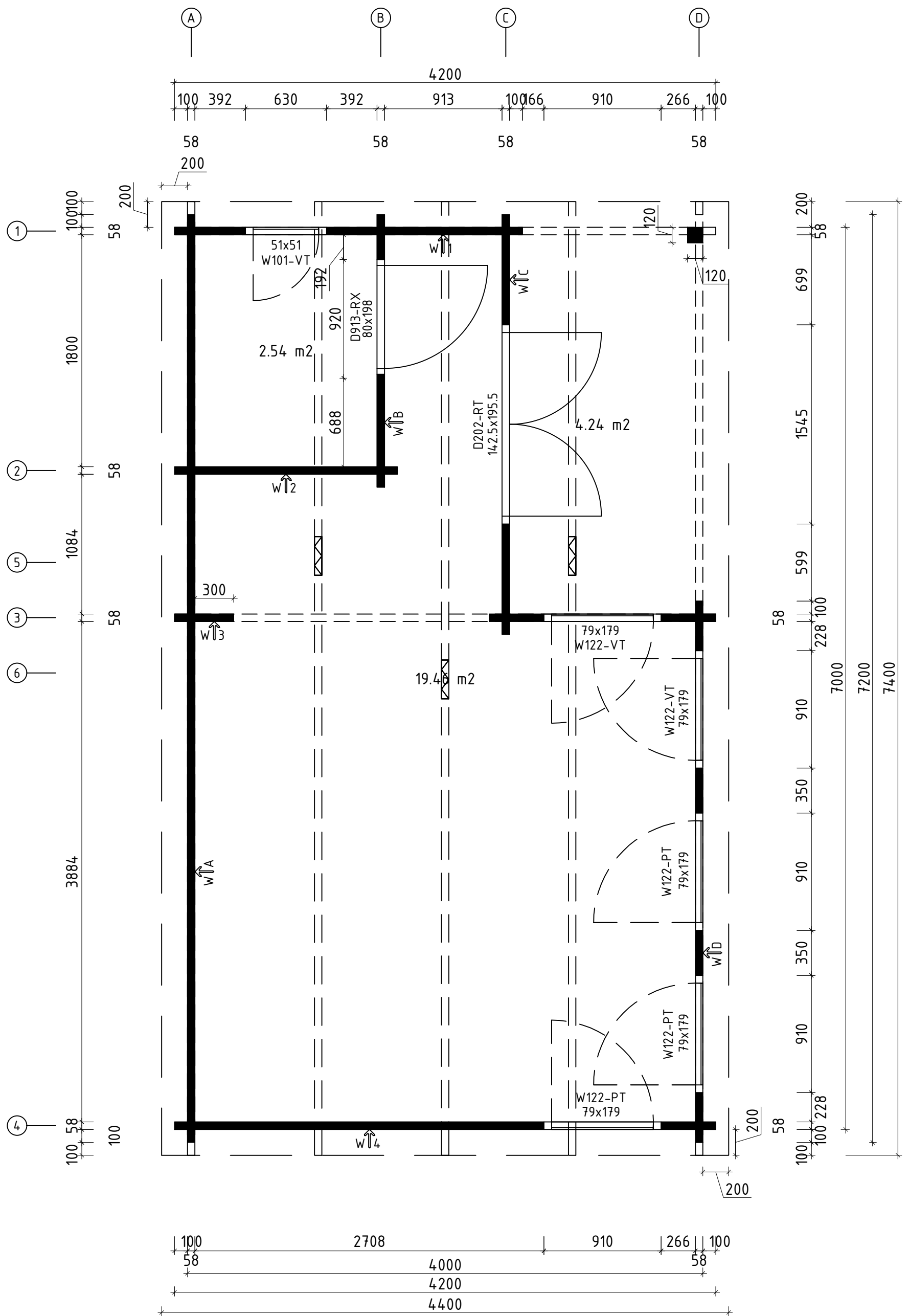







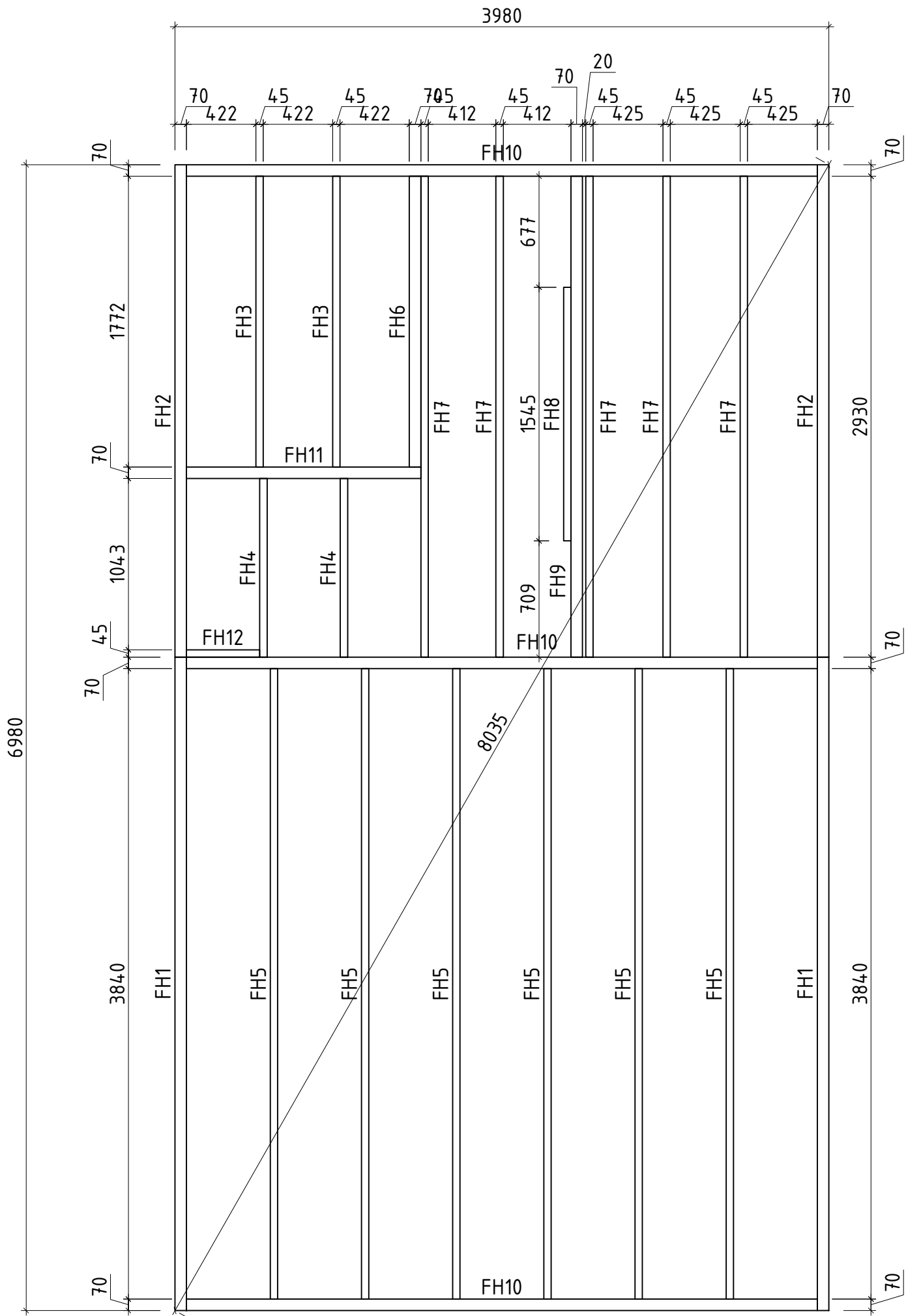
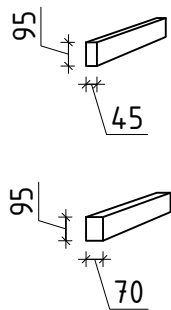

\* Fenster und Türen sind ohne Sprossen  
 Windows and doors are without muntins

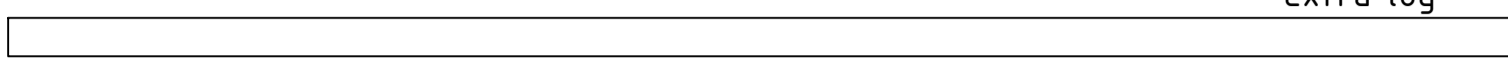
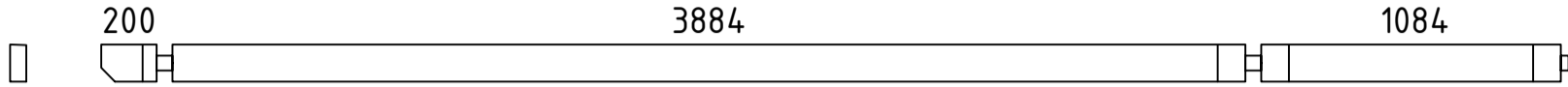
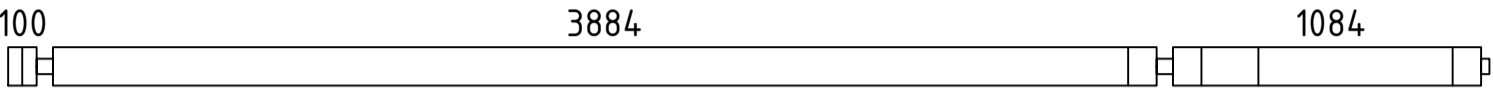
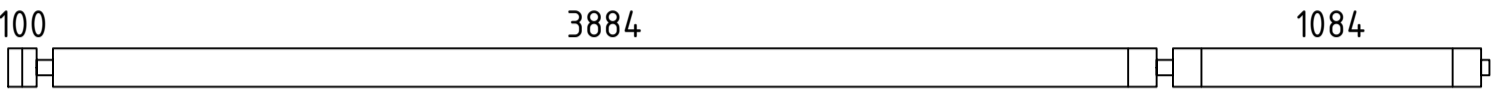

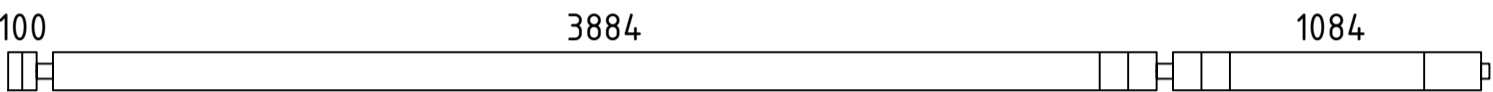

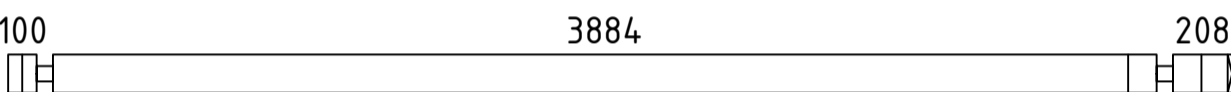
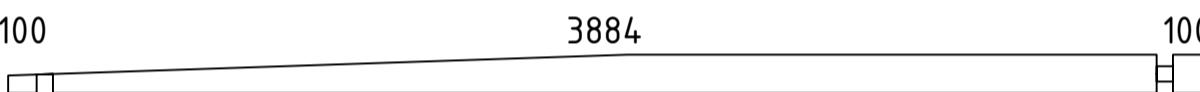

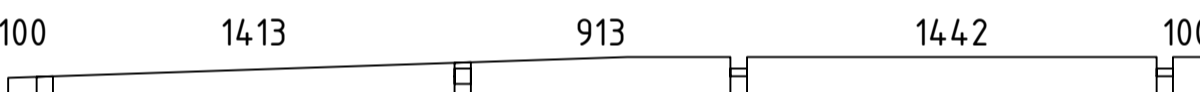
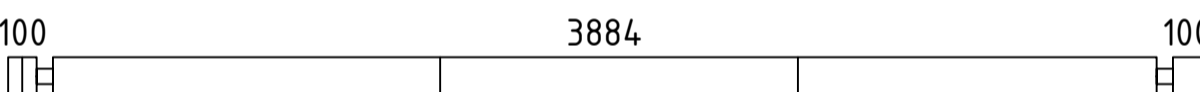
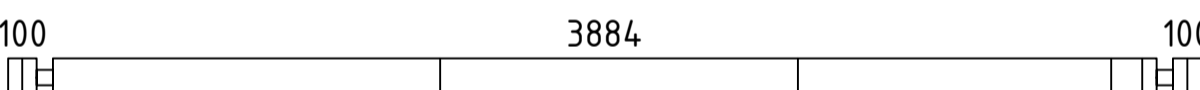
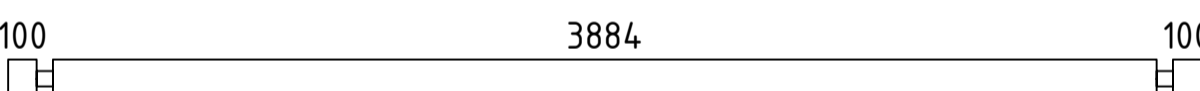
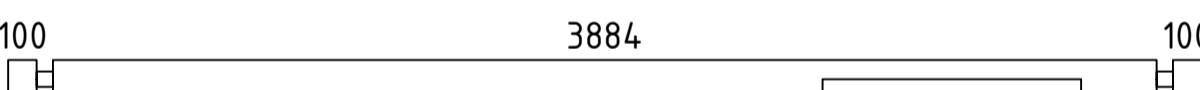
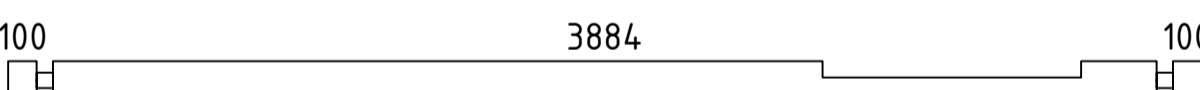
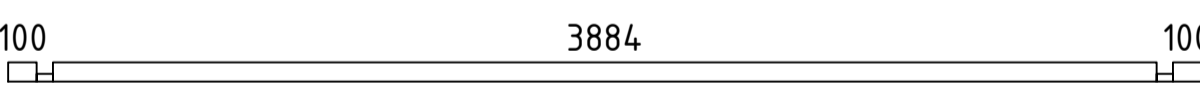
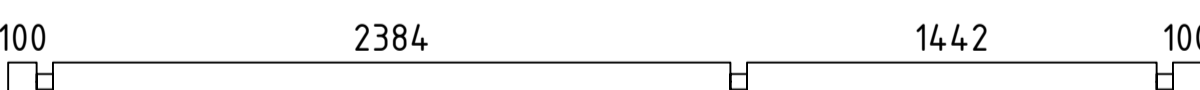
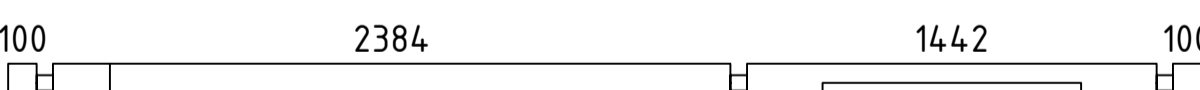
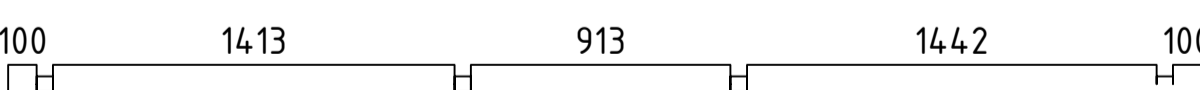

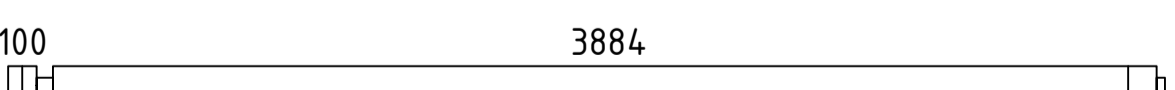
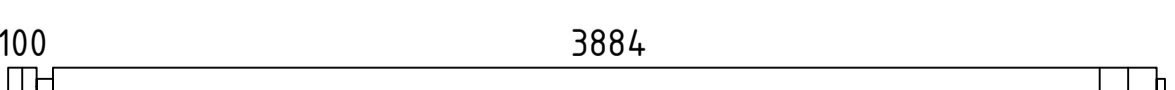
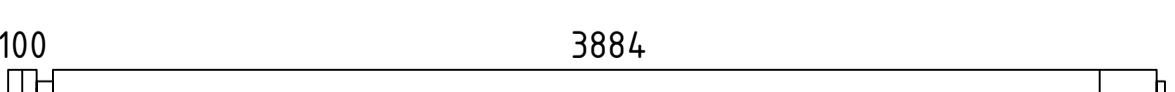
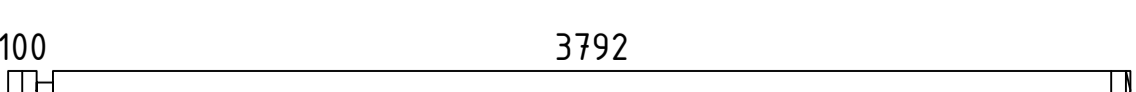

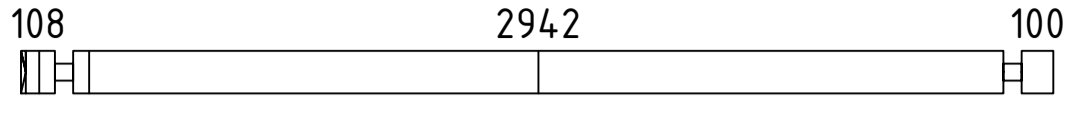
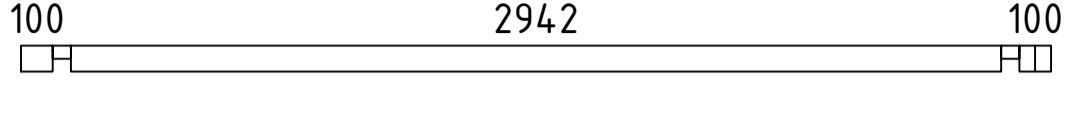
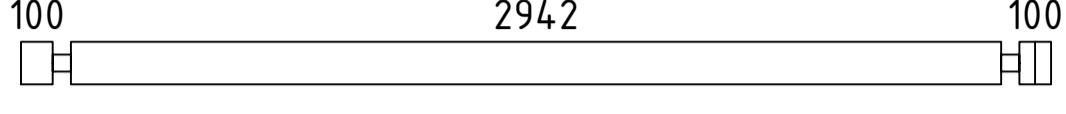
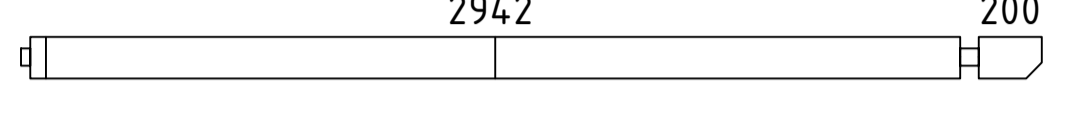
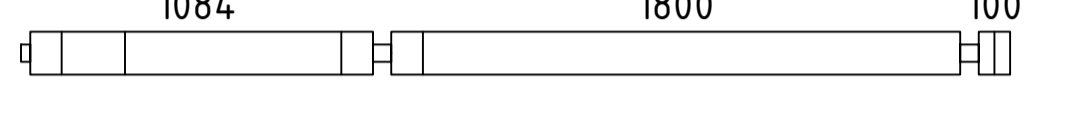
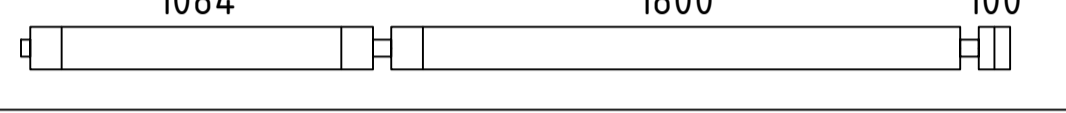
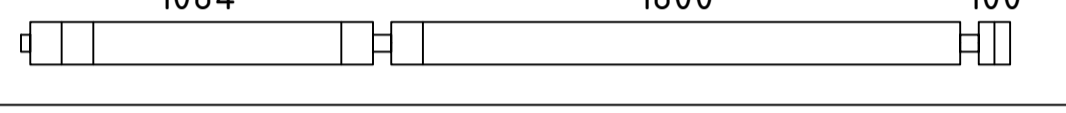
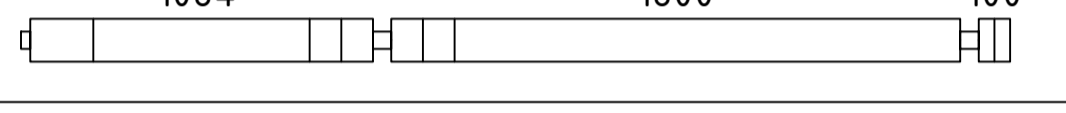
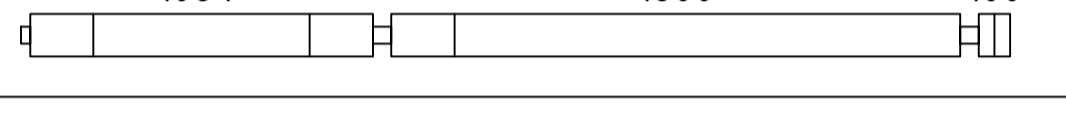
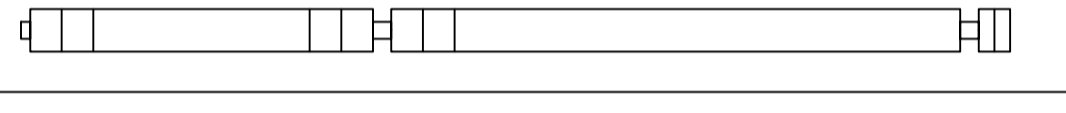
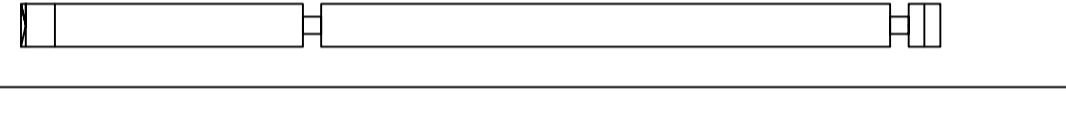
**Q5** – Qualitätsklasse für Fenster und Türen/  
 Quality class for windows and doors

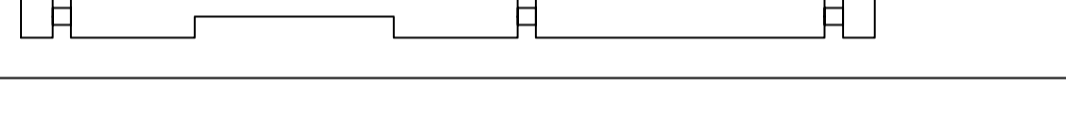
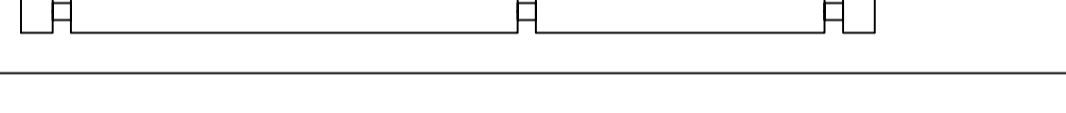
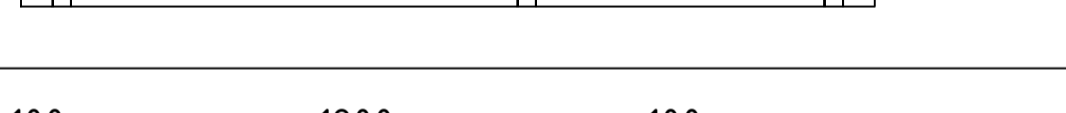

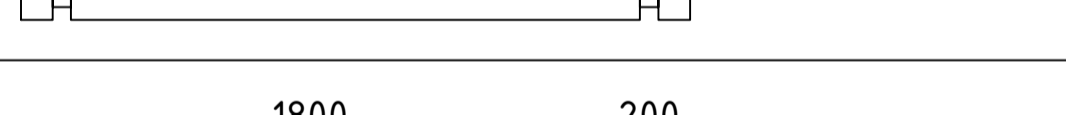
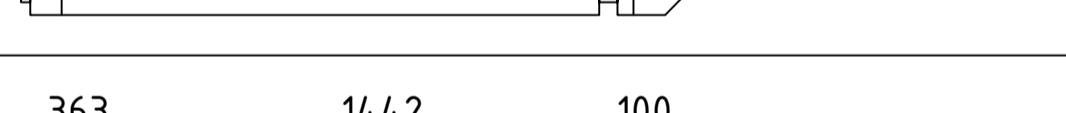

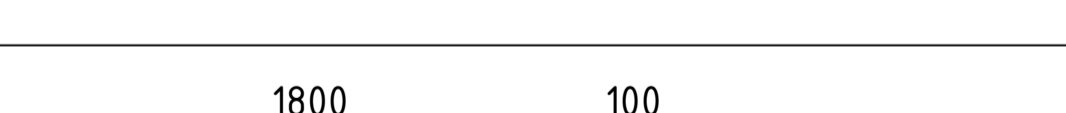

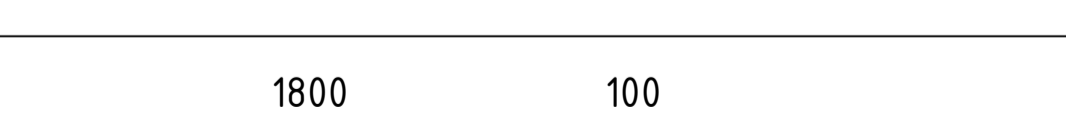
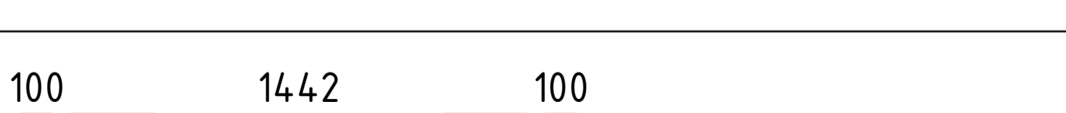
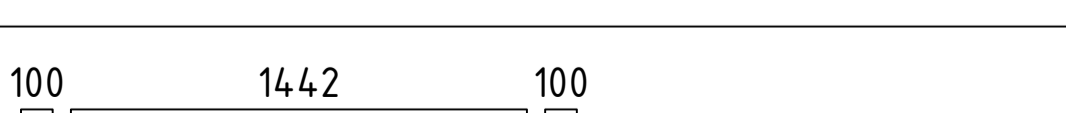



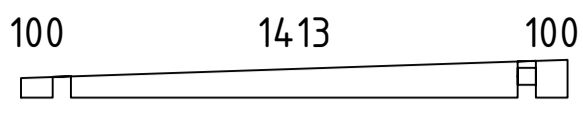
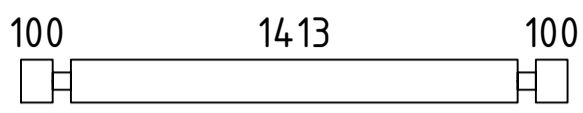
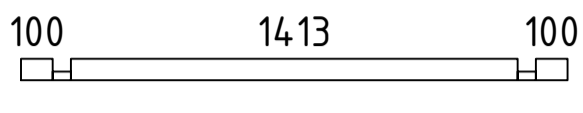
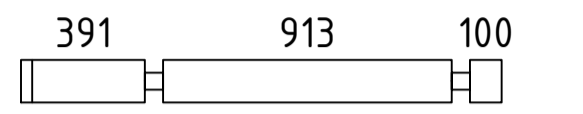

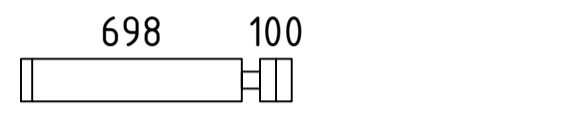
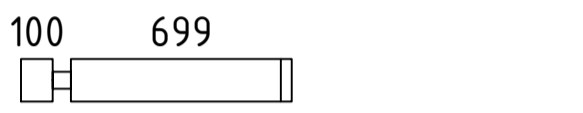

Name	Malaga 2 420x720_58		
Zeichnung/Drawing	Grundplan, Plan		
Profil/Profile	5.8x13.5	Datum/Date	11.04.2022









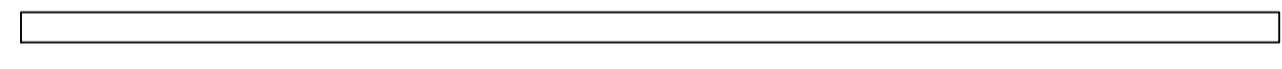
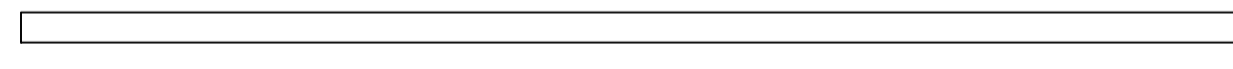
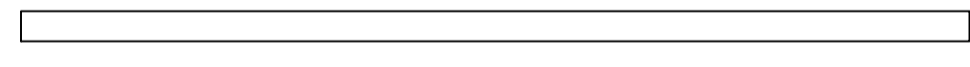
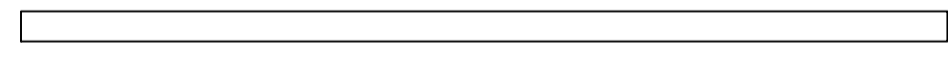
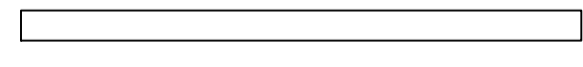
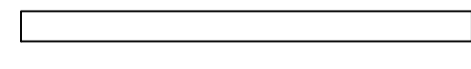
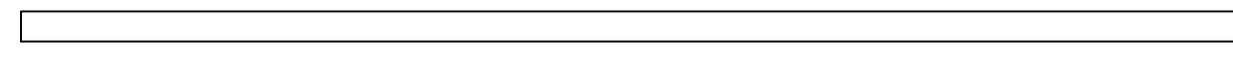

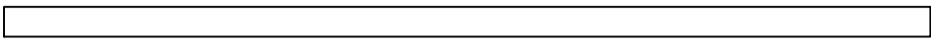
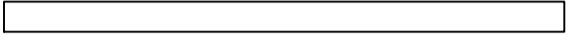
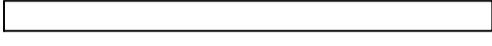

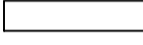
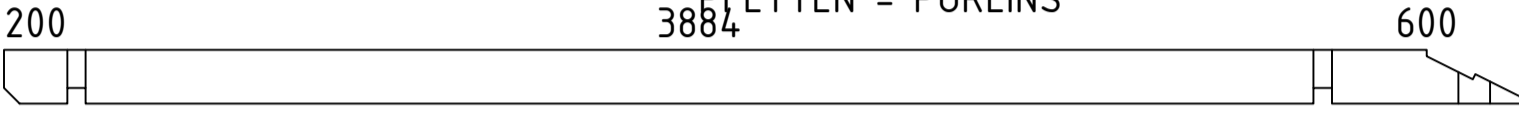
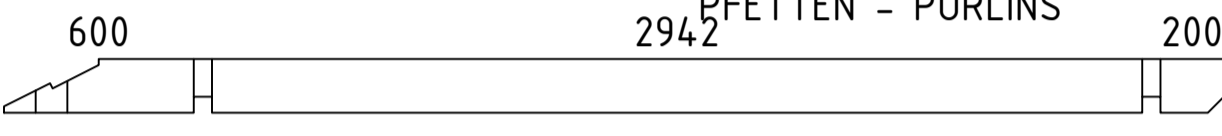
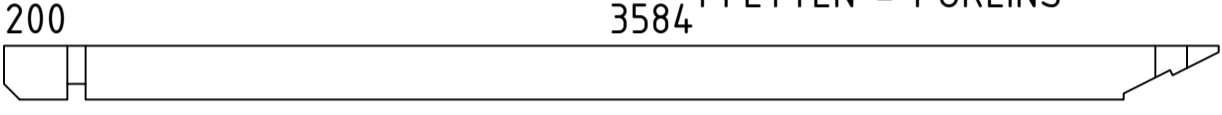
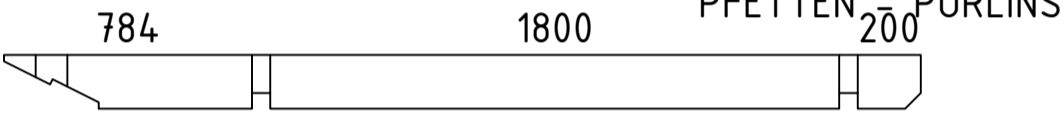

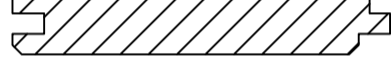







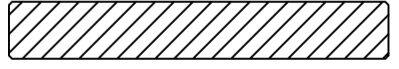
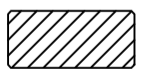

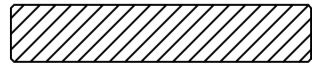

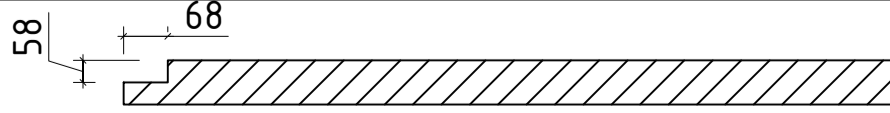





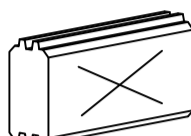
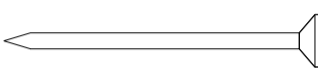
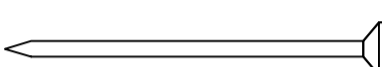

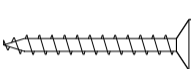

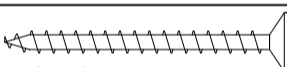

Name	Malaga 2 420x720_58		
Zeichnung/Drawing	Lagerholzplan_Foundation beams		
Profil/Profile	5.8x13.5	Datum/Date	11.04.2022

Pos	Teileliste/Specification Malaga 2 420x720_58	Stck. Pcs.	Profil Profile (mm)	Länge Length (mm)
	Achtung! Die Giebelbohlen können teilweise schon vormontiert sein! Bitte beachten - diese erscheinen nicht ganz so wie in der Teileliste beschrieben.			
	Notice! The gable pieces can be partly pre-assembled! Please notice - those differ from the description given in the specification list.			
000	extra log 	1	58x135	5313
001		1	58x135	5313
002		1	58x135	5213
003		2	58x135	5213
004		1	58x135	5213
005		1	58x135	5213
006		1	58x135	5213
007		1	58x135	5213
008		1	58x135	4307
009		1	58x135	4200
010		1	58x135	4200
011		1	58x135	4200
012		1	58x135	4200
013		1	58x135	4200
014		1	58x135	4200
015		1	58x135	4200
016		1	58x135	4200
017		1	58x68	4200
018		1	58x135	4200
019		1	58x135	4200
020		1	58x135	4200
021		1	58x132	4171
022		4	58x135	4071
023		2	58x135	4071
024		2	58x135	4071
025		1	58x135	3950
Kood	Malaga 2 420x720_58	Materjal	File	Leht 1/7



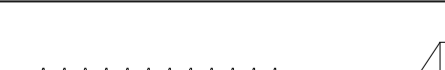

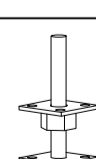
Pos	Teieliste/Specification Malaga 2 420x720_58	Stck. Pcs.	Profil Profile (mm)	Länge Length (mm)
026		1	58x135	3265
027		1	58x82	3258
028		2	58x135	3258
029		1	58x132	3229
030		1	58x135	3129
031		3	58x135	3129
032		1	58x135	3129
033		1	58x135	3129
034		1	58x135	3129
035		1	58x135	3129
036		1	58x135	2908
037		13	58x135	2866
038		1	58x135	2700
039		10	58x135	2700
040		1	58x68	2700
041		1	58x49	2116
042		2	58x135	2116
043		1	58x135	2087
044		2	58x68	2021
045		1	58x68	2021
046		3	58x135	1987
047		2	58x135	1987
048		2	58x135	1987
049		1	58x135	1758
050		1	58x68	1758

Pos	Teileliste/Specification Malaga 2 420x720_58	Stck. Pcs.	Profil Profile (mm)	Länge Length (mm)
051		1	58x120	1729
052		16	58x135	1729
053		1	58x68	1729
054		4	58x135	1520
055		15	58x135	876
056		15	58x135	856
057		15	58x135	856
058		4	58x135	550
059		7	58x135	458
060		4	58x135	458
061		3	58x135	458
062		1	58x68	458
063		39	58x135	424
064		14	58x135	385
065		14	58x135	385
066		15	58x135	350
067		20	58x135	350
068		8	58x135	350
FH1	FUNDAMENTHOLZ (imprägniert) - FOUNDATION BEAM (impregnated) 	2	70x95	3980
FH10	FUNDAMENTHOLZ (imprägniert) - FOUNDATION BEAM (impregnated) 	3	70x95	3840
FH2	FUNDAMENTHOLZ (imprägniert) - FOUNDATION BEAM (impregnated) 	2	70x95	3000
FH9	FUNDAMENTHOLZ (imprägniert) - FOUNDATION BEAM (impregnated) 	1	70x95	2930
FH6	FUNDAMENTHOLZ (imprägniert) - FOUNDATION BEAM (impregnated) 	1	70x95	1772
FH11	FUNDAMENTHOLZ (imprägniert) - FOUNDATION BEAM (impregnated) 	1	70x95	1427
FH5	FUNDAMENTHOLZ (imprägniert) - FOUNDATION BEAM (impregnated) 	6	45x95	3840
Kood	Malaga 2 420x720_58	Materjal	File	Leht 3/7

Pos	Teileliste/Specification Malaga 2 420x720_58		Stck. Pcs.	Profil Profile (mm)	Länge Length (mm)	
FH7	FUNDAMENTHOLZ (imprägniert) - FOUNDATION BEAM (impregnated) 		5	45x95	2930	
FH3	FUNDAMENTHOLZ (imprägniert) - FOUNDATION BEAM (impregnated) 		2	45x95	1772	
FH8	FUNDAMENTHOLZ (imprägniert) - FOUNDATION BEAM (impregnated) 		1	45x95	1545	
FH4	FUNDAMENTHOLZ (imprägniert) - FOUNDATION BEAM (impregnated) 		2	45x95	1088	
FH12	FUNDAMENTHOLZ (imprägniert) - FOUNDATION BEAM (impregnated) 		1	45x95	445	
PF1	PFETTEN - PURLINS 		2	58x170	4800	
PF4	PFETTEN - PURLINS 		1	58x170	3858	
PF3	PFETTEN - PURLINS 		1	58x170	3842	
PF2	PFETTEN - PURLINS 		1	58x170	2900	
PF5	PFETTEN - PURLINS 		1	58x170	2900	
	DACHBRETTEN - ROOF BOARDS 		66+1	113x18	4400	
	FUSSBODENBRETTEN - FLOOR BOARDS 		35+1	113x28	3880	
	FUSSBODENBRETTEN - FLOOR BOARDS 		10	113x28	2380	
	FUSSBODENBRETTEN - FLOOR BOARDS 		16	113x28	1410	
	FUSSBODENBRETTEN - FLOOR BOARDS 		16	113x28	910	
	TERRASSENBRETTEN (imprägniert) - TERRACE BOARDS (impregnated) 		24+1	120x28	1495	
	FUSSBODENLEISTEN - FLOOR STRIPS 		✓	14x55	30.0 lfm/rm	
	DECKENLEISTEN - CEILING STRIPS 		✓	15x28	34.0 lfm/rm	
G02-1	GIEBELBRETTEN - GABLE BOARDS 18x120 		✓	2	18x120	4420
G05-1	GIEBELDECKLEISTEN - GABLE COVER STRIPS 18x40 		✓	4	18x40	2200
T02-1	TRAUFENBRETTEN - EAVES BOARDS 18x120 			2	18x120	3718
T01-1	TRAUFENBRETTEN - EAVES BOARDS 18x95 			2	18x95	3700
T04-1	TRAUFENDECKLEISTEN - EAVES COVER STRIPS 18x40 		✓		18x40	8.0 lfm/rm
T06-1	TRAUFENLEISTEN - EAVES STRIPS 18x40 		✓		18x40	15.0 lfm/rm
TP1 20-1	STÜTZPFOSTE - SUPPORT POST 120x120 			1	120x120	2100
Kood	Malaga 2 420x720_58	Materjal	File		Leht 4/7	

Pos	Teileliste/Specification Malaga 2 420x720_58			Stck. Pcs.	Profil Profile (mm)	Länge Length (mm)
TL58-1	T-LEISTEN - T-STRIPS 58			2	45x58	490
TL58-2	T-LEISTEN - T-STRIPS 58			4	45x58	1705
TL58-3	T-LEISTEN - T-STRIPS 58			6	45x58	1840
TL58-4	T-LEISTEN - T-STRIPS 58			4	45x58	1975
SH	SCHLAGHÖLZER - MOUNTING PIECES			3		
NG2550	NÄGEL - NAILS 2.5x50 Dachbretter - Roof boards			660		
NG2560	NÄGEL - NAILS 2.5x60 Fussbodenbretter - Floor boards			921		
NG2560	NÄGEL - NAILS 2.5x60 Terrassenbretter - Terrace boards			192		
SR3030	Schrauben - Screws 3.0x30 Deckenleisten - Ceiling strips			68		
SR3030	Schrauben - Screws 3.0x30 Fussbodenleisten - Floor strips			58		
SR3030	Schrauben - Screws 3.0x30 Giebeldeckleisten - Gable cover strips			20		
SR3030	Schrauben - Screws 3.0x30 Traufendeckleisten strips			16		
SR3030	Schrauben - Screws 3.0x30 Traufenleisten - Eaves strips			32		
SR37	Schrauben - Screws 3.5x45 Tür/Fenster leisten - Door/Window strips			202		
SR3545	Schrauben - Screws 3.5x45 Giebelbretter - Gable boards			20		
SR3545	Schrauben - Screws 3.5x45 Traufenbretter - Eaves boards			32		
SR3545-001	Schrauben - Screws 3.5x45 Verbindungsstreifen strip			68		
SR44	Schrauben - Screws 4.0x60 Wasserleisten - Rain strips WL1			21		
SR50100	Schrauben - Screws 5.0x100 Fundamenthölzer - Foundation beams			104		
SR50100	Schrauben - Screws 5.0x100 Stützpfofte - Support post			6		
SR5070-002	Schrauben - Screws 5.0x70 Verstellbare pfoftenstütze - Post support			8		
VS	Verbindungsstreifen für verbinden der Wandbohlen - Connecting strip for connecting the wall parts			17		
VP3	Verstellbare Pfoftenstütze - Adjustable post support M20			1		
ML1	Metallstange - Metal bar			16	D10	900
ML2	Metallstange - Metal bar			4	D10	770
Kood	Malaga 2 420x720_58	Materjal	File	Leht 5/7		

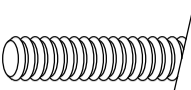
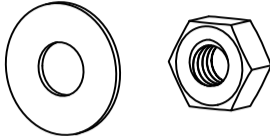
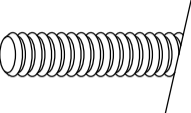
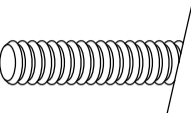
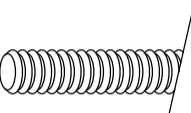
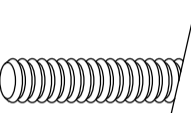
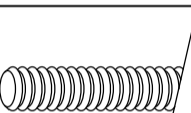

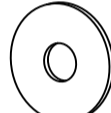
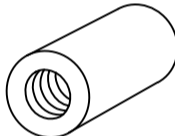
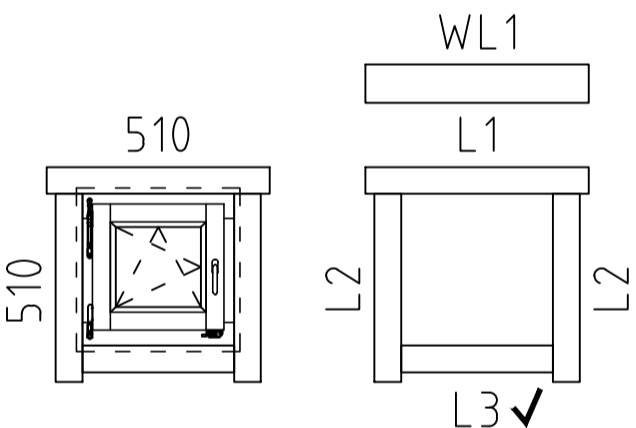
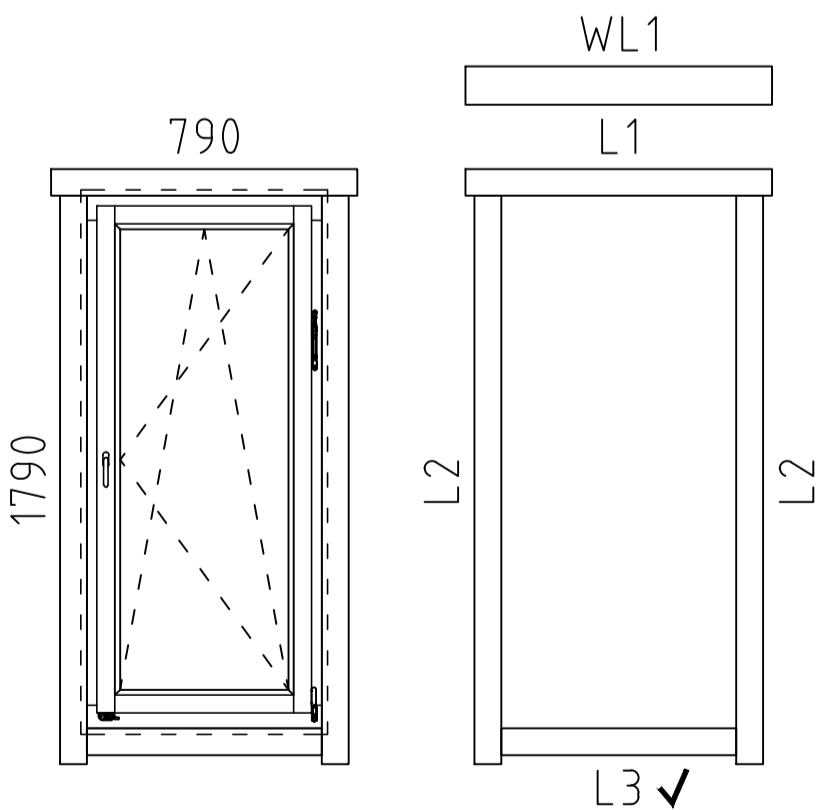
Pos	Teileliste/Specification Malaga 2 420x720_58	Stck. Pcs.	Profil Profile (mm)	Länge Length (mm)
ML3	Metallstange - Metal bar 	1	D10	700
ML4	Metallstange - Metal bar 	4	D10	360
KL-1	Gewindestange - Threaded rod M12- für die Pfetten - for purlins 	6		170
MUT26	Mutter - Nut M12 U-Scheibe - Washer Ø30- für die Pfetten - for purlins 	12		
KL1	Gewindestange - Threaded Rod M8 	4		2000
KL2	Gewindestange - Threaded Rod M8 	1		457
KL3	Gewindestange - Threaded Rod M8 	1		407
KL4	Gewindestange - Threaded Rod M8 	2		325
KL5	Gewindestange - Threaded Rod M8 	1		267
KV M UT M8	Mutter - Nut M8 	10		
KV S EIB M8X25	U-Scheibe - Washer M8 Ø25 	10		
KV MU TJ M8	Befestigungsmutter - Fixing nut M8 	4		
	<p>FENSTER/WINDOW Q5 W5-S58V-0XT-05100510</p> <p>W101-VT</p>  <p>510</p> <p>510</p> <p>WL1</p> <p>L1</p> <p>L2</p> <p>L2</p> <p>L3 ✓</p> <p>L1 18x90 L=750mm 2x L2 18x90 L=630mm 4x ✓ L3 18x90 L=510mm 2x WL1 36x129 L=750mm 1x</p>	1		
	<p>FENSTER/WINDOW Q5 W5-S58P-0XT-07901790</p> <p>W122-PT</p>  <p>790</p> <p>1790</p> <p>WL1</p> <p>L1</p> <p>L2</p> <p>L2</p> <p>L3 ✓</p> <p>L1 18x90 L=1030mm 2x L2 18x90 L=1910mm 4x L3 18x90 L=790mm 2x ✓ WL1 36x129 L=1030mm 1x</p>	3		
Kood	Malaga 2 420x720_58	Materjal	File	Leht 6/7

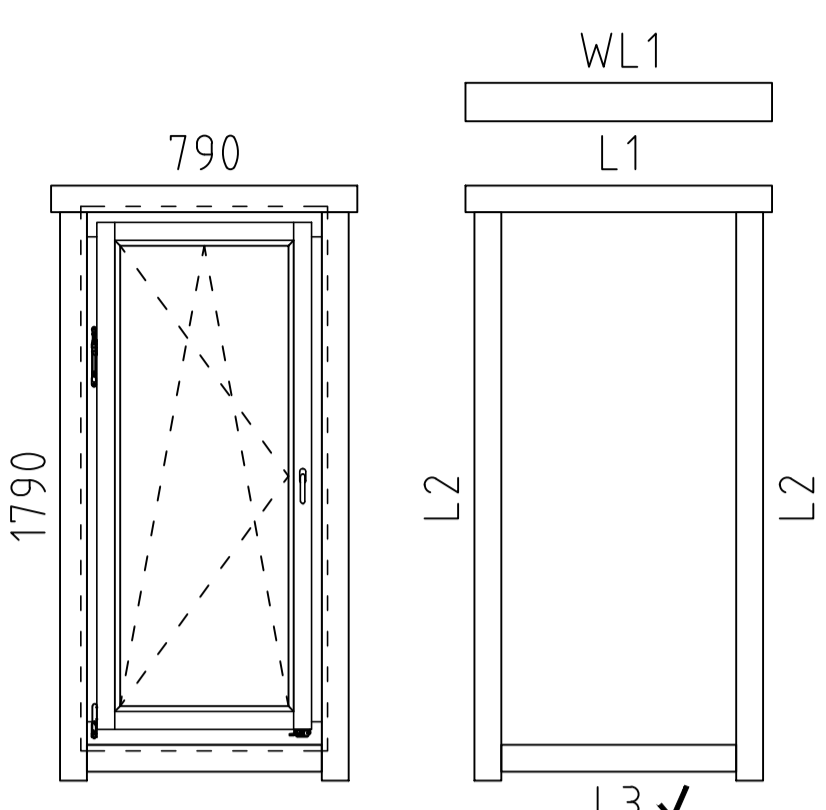
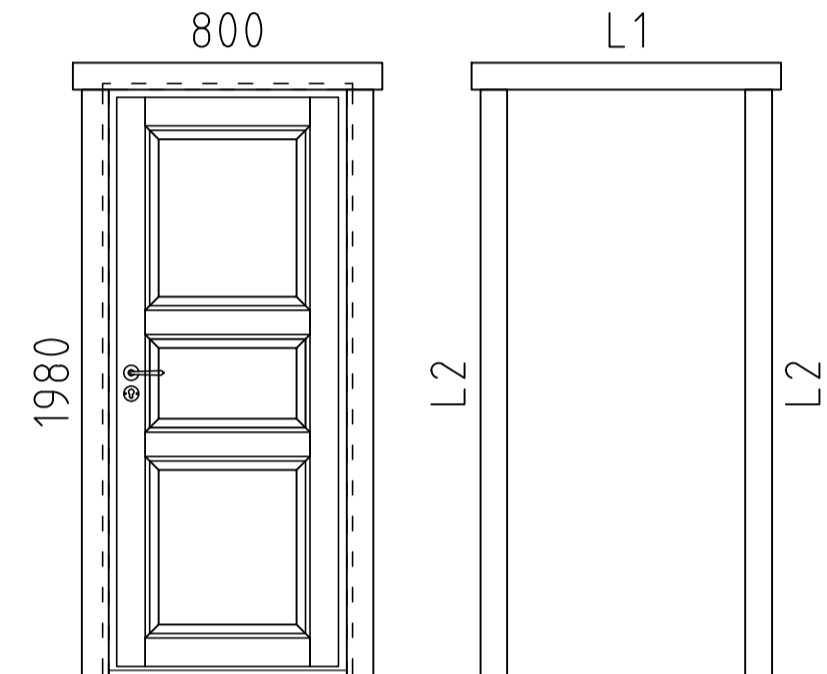
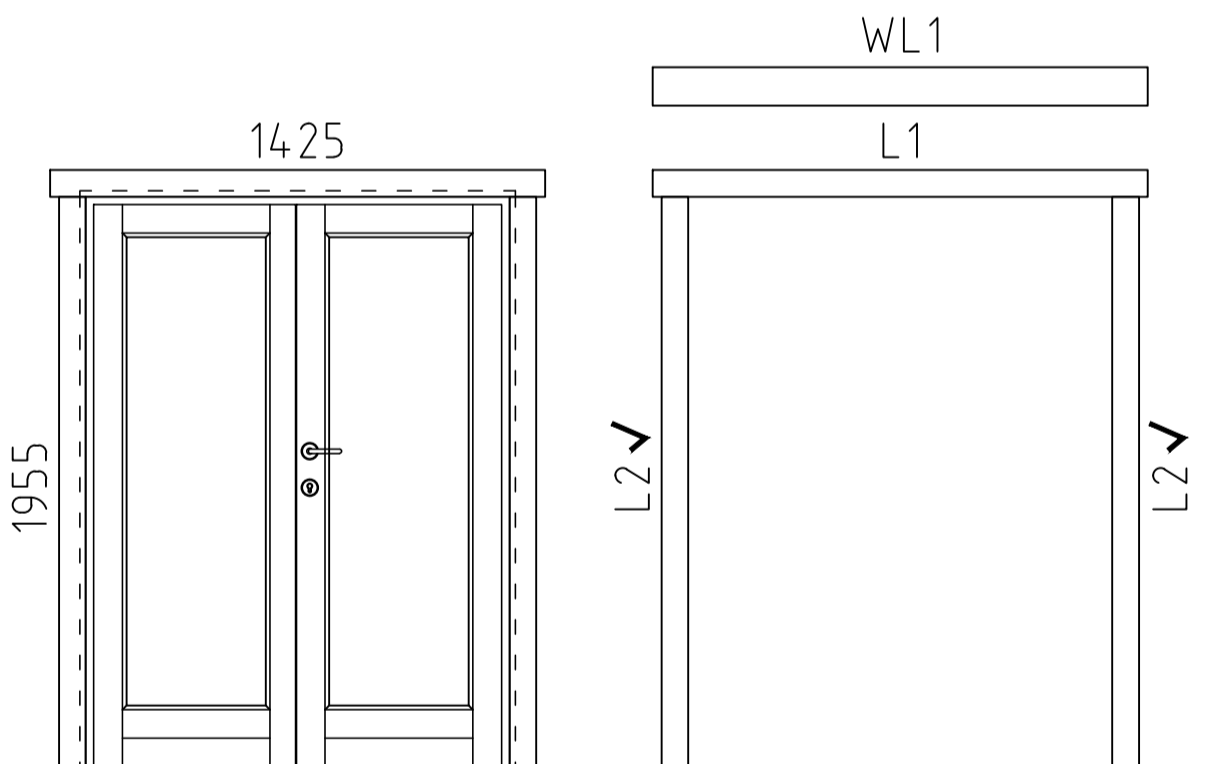
Pos	Teileliste/Specification Malaga 2 420x720_58	Stck. Pcs.	Profil Profile (mm)	Länge Length (mm)																
	<p style="text-align: center;"><b>FENSTER/WINDOW Q5</b> <b>W5-S58V-0XT-07901790</b></p>  <p style="text-align: center;">W122-VT</p> <table border="0"> <tr> <td>L1</td> <td>18x90</td> <td>L=1030mm</td> <td>2x</td> </tr> <tr> <td>L2</td> <td>18x90</td> <td>L=1910mm</td> <td>4x</td> </tr> <tr> <td>L3</td> <td>18x90</td> <td>L=790mm</td> <td>2x ✓</td> </tr> <tr> <td>WL1</td> <td>36x129</td> <td>L=1030mm</td> <td>1x</td> </tr> </table>	L1	18x90	L=1030mm	2x	L2	18x90	L=1910mm	4x	L3	18x90	L=790mm	2x ✓	WL1	36x129	L=1030mm	1x	2		
L1	18x90	L=1030mm	2x																	
L2	18x90	L=1910mm	4x																	
L3	18x90	L=790mm	2x ✓																	
WL1	36x129	L=1030mm	1x																	
	<p style="text-align: center;"><b>TÜR/DOOR</b> <b>D0-I58R-XXX-08001980</b></p>  <p style="text-align: center;">D913-RX</p> <table border="0"> <tr> <td>L1</td> <td>18x90</td> <td>L=1040mm</td> <td>2x</td> </tr> <tr> <td>L2</td> <td>18x90</td> <td>L=1980mm</td> <td>4x ✓</td> </tr> </table> <p style="text-align: center;">DIN rechts / right handed</p>	L1	18x90	L=1040mm	2x	L2	18x90	L=1980mm	4x ✓	1										
L1	18x90	L=1040mm	2x																	
L2	18x90	L=1980mm	4x ✓																	
	<p style="text-align: center;"><b>TÜR/DOOR Q6</b> <b>D5-D58R-0XT-14251955</b></p>  <p style="text-align: center;">D202-RT</p> <table border="0"> <tr> <td>L1</td> <td>18x90</td> <td>L=1665mm</td> <td>2x</td> </tr> <tr> <td>L2</td> <td>18x90</td> <td>L=1955mm</td> <td>4x ✓</td> </tr> <tr> <td>WL1</td> <td>36x129</td> <td>L=1665mm</td> <td>1x</td> </tr> </table> <p style="text-align: center;">DIN rechts / right handed</p>	L1	18x90	L=1665mm	2x	L2	18x90	L=1955mm	4x ✓	WL1	36x129	L=1665mm	1x	1						
L1	18x90	L=1665mm	2x																	
L2	18x90	L=1955mm	4x ✓																	
WL1	36x129	L=1665mm	1x																	
	<p>✓ - Bitte selber anpassen (falls nötig)! / Cut into length on site (if needed)!</p>																			

# Montageanleitung für T-Leisten / Installing the door and window supports / Tenderliistu paigaldusjuhend.

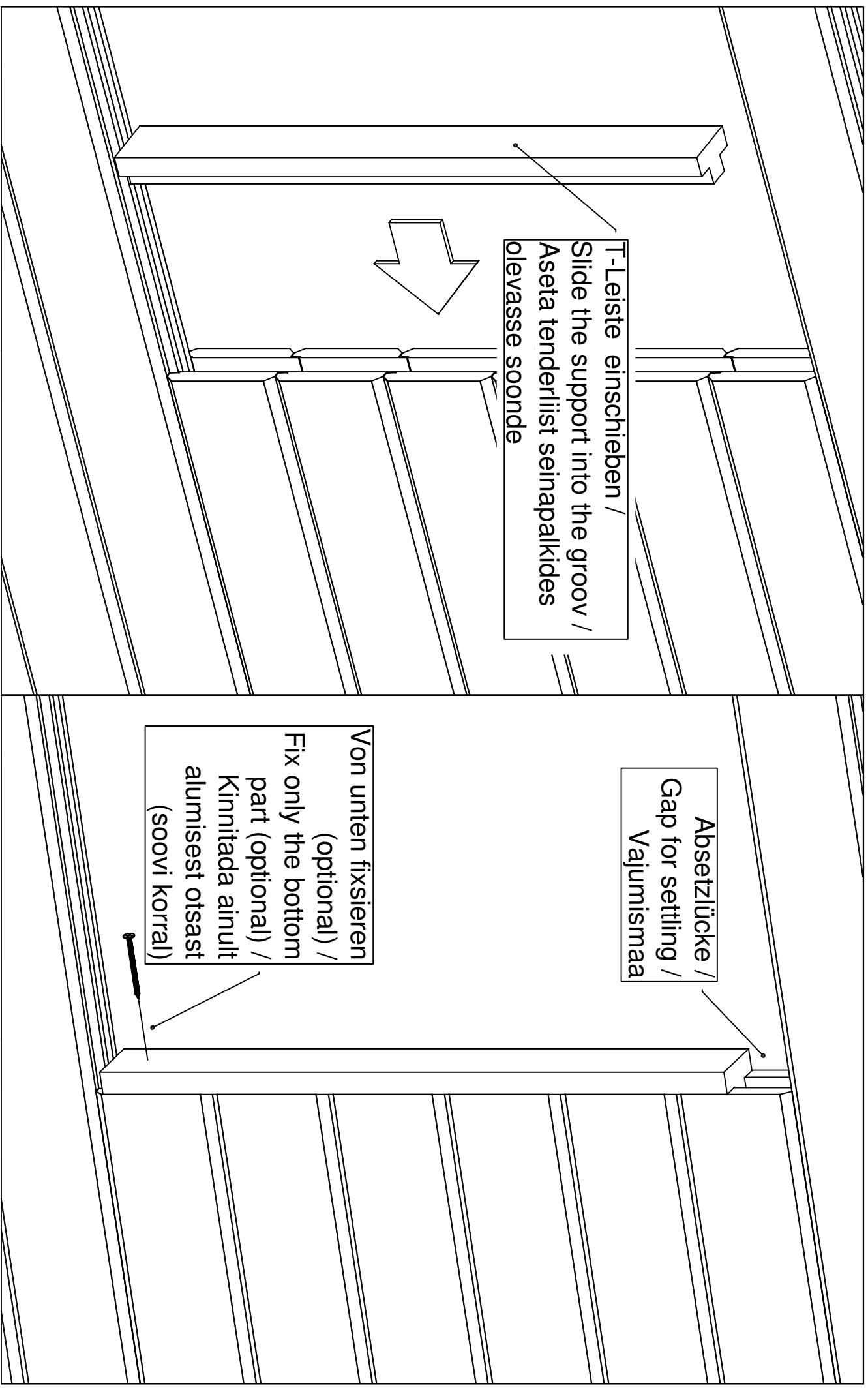

Aken	Q4-Q6	-	paigaldusjuhhis
Window	Q4-Q6	-	assembly instructions
Fenster	Q4-Q6	-	Montageanleitung

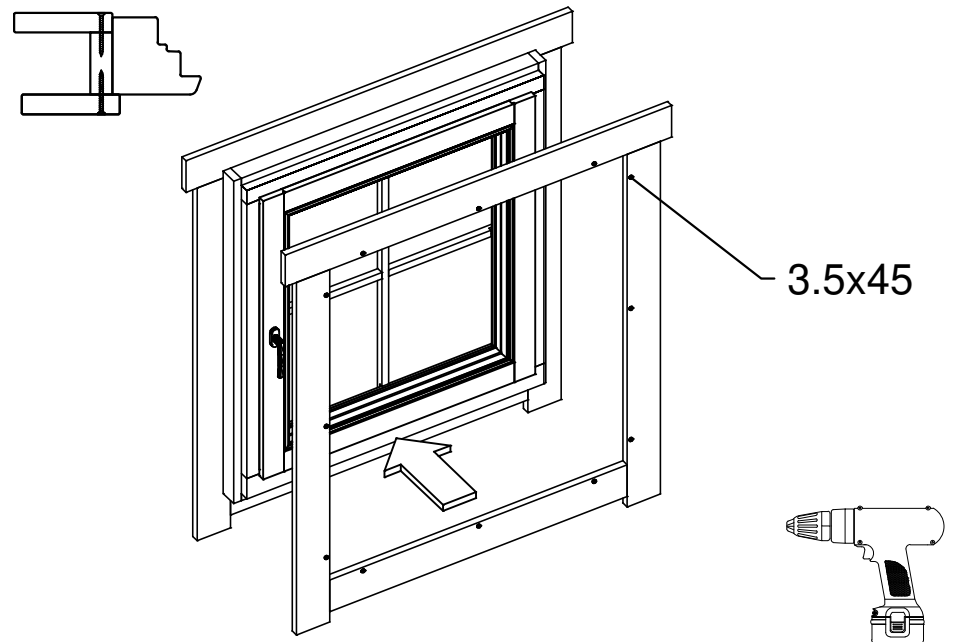
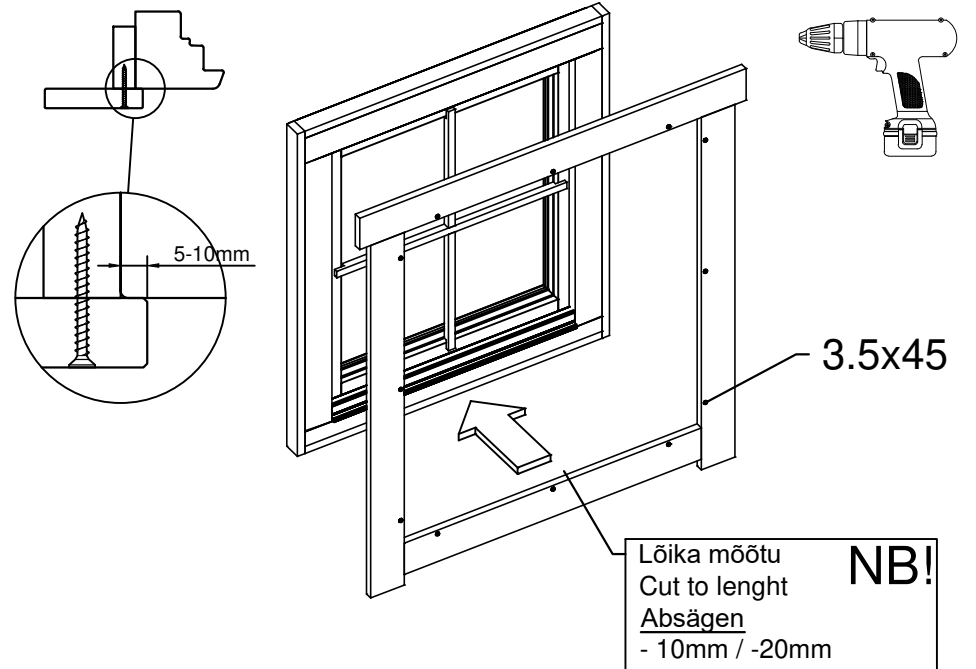
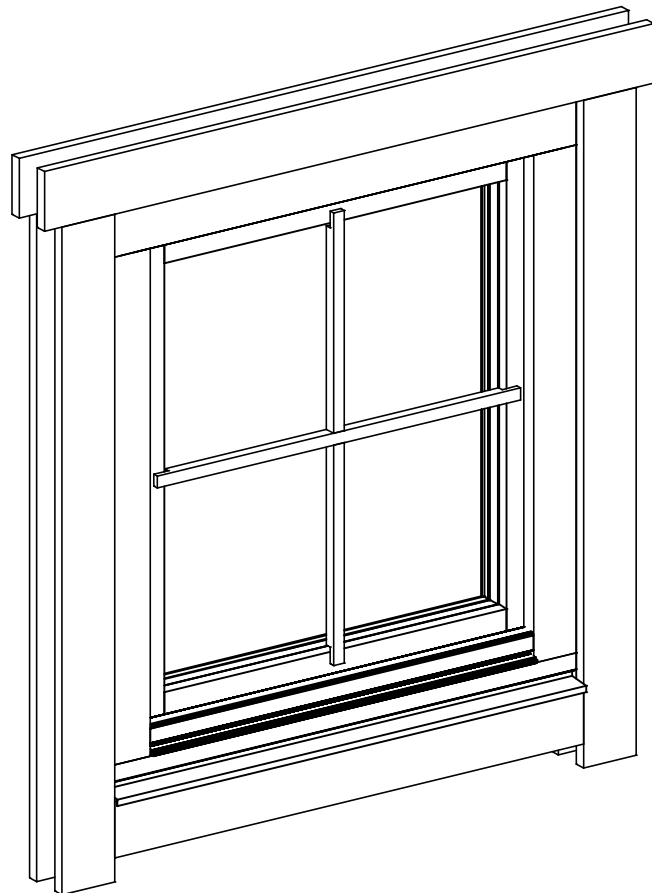

Vihmaliist / Rain strip / Wasserleiste

# Q5-Q6

\*Silikoon  
\*Silicon  
\*Silikon

\*Vajumispiilu  
\*Settling gap  
\*Senkungs spalt

ca 40-50mm

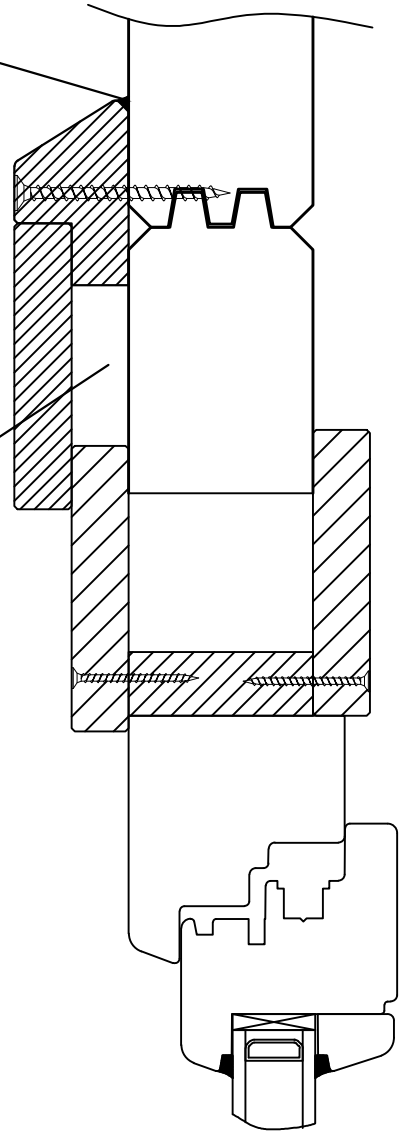
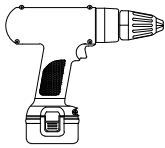

NB!

- Monteerida juhul kui ese on välja toodud maja spetsifikatsioonis!
- Install only if the item is listed in the house specification!
- Nur montieren wenn die Leiste in der Teilleiste gezeigt ist!

Veepilekk / Window sill / Fensterbank

4,2x16

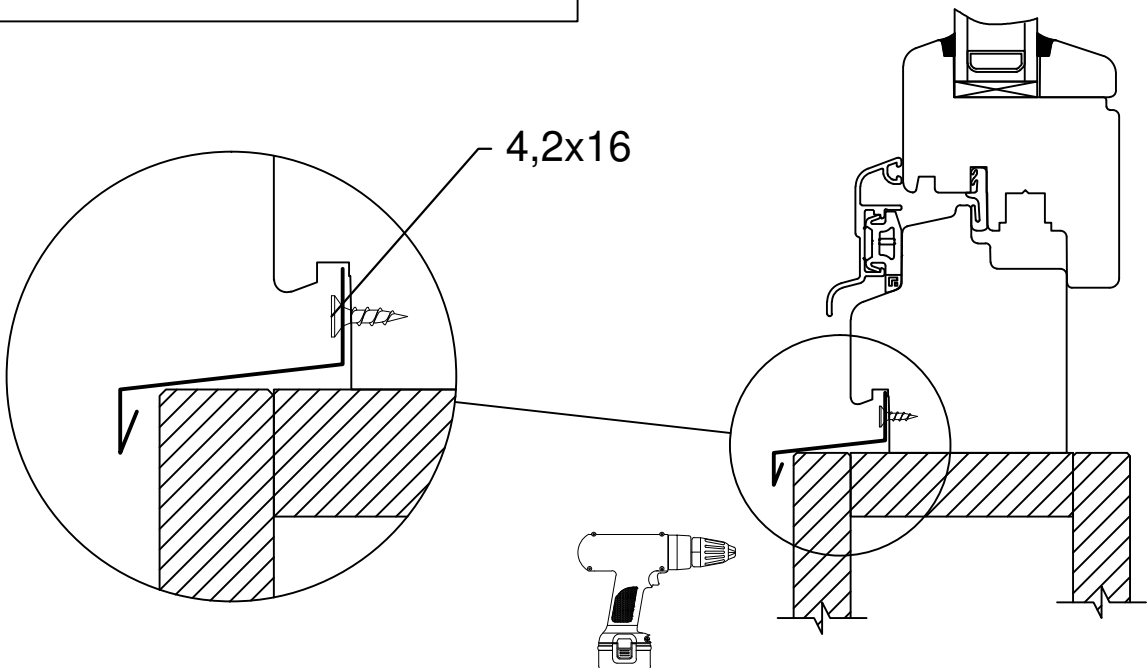

Ukse montaaž / Tür montage / Door assembly  
(GH+ / SH)

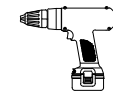
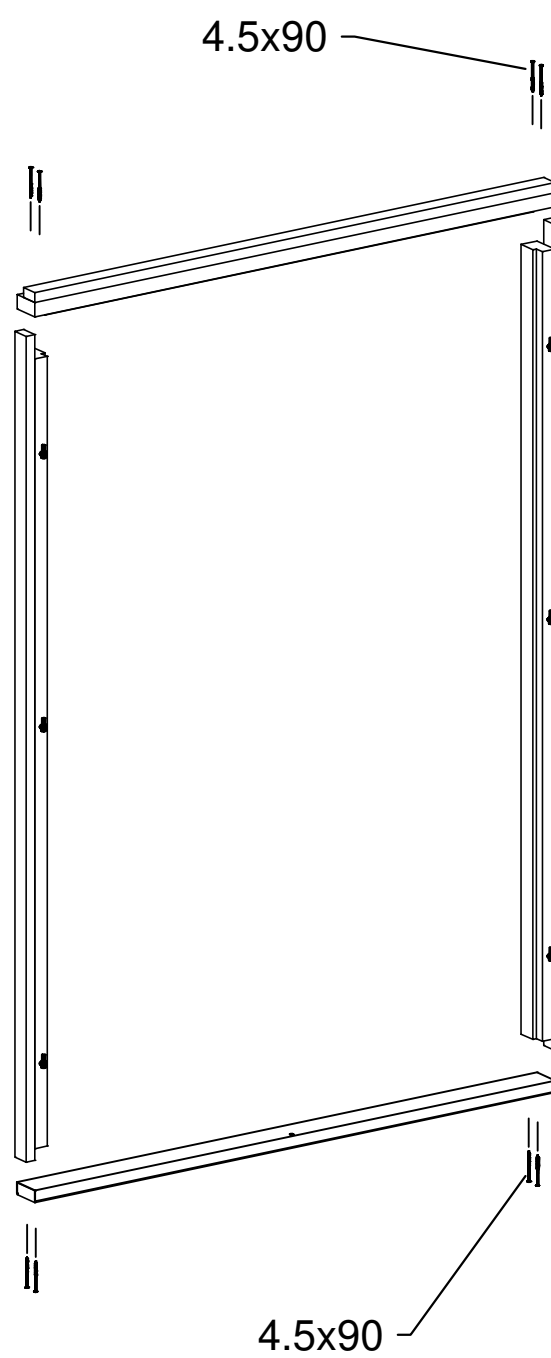
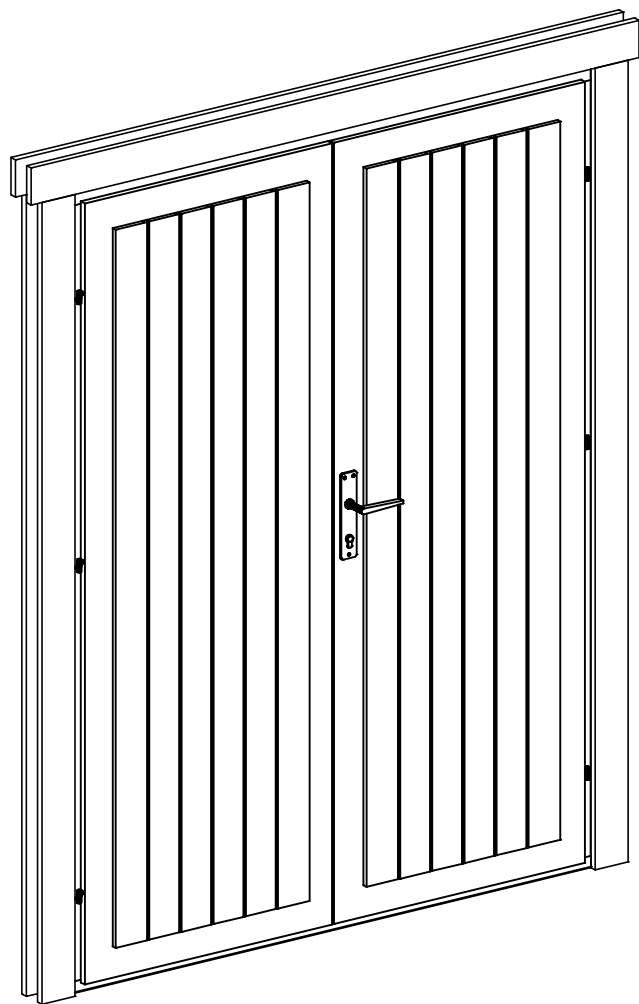

4.5x90

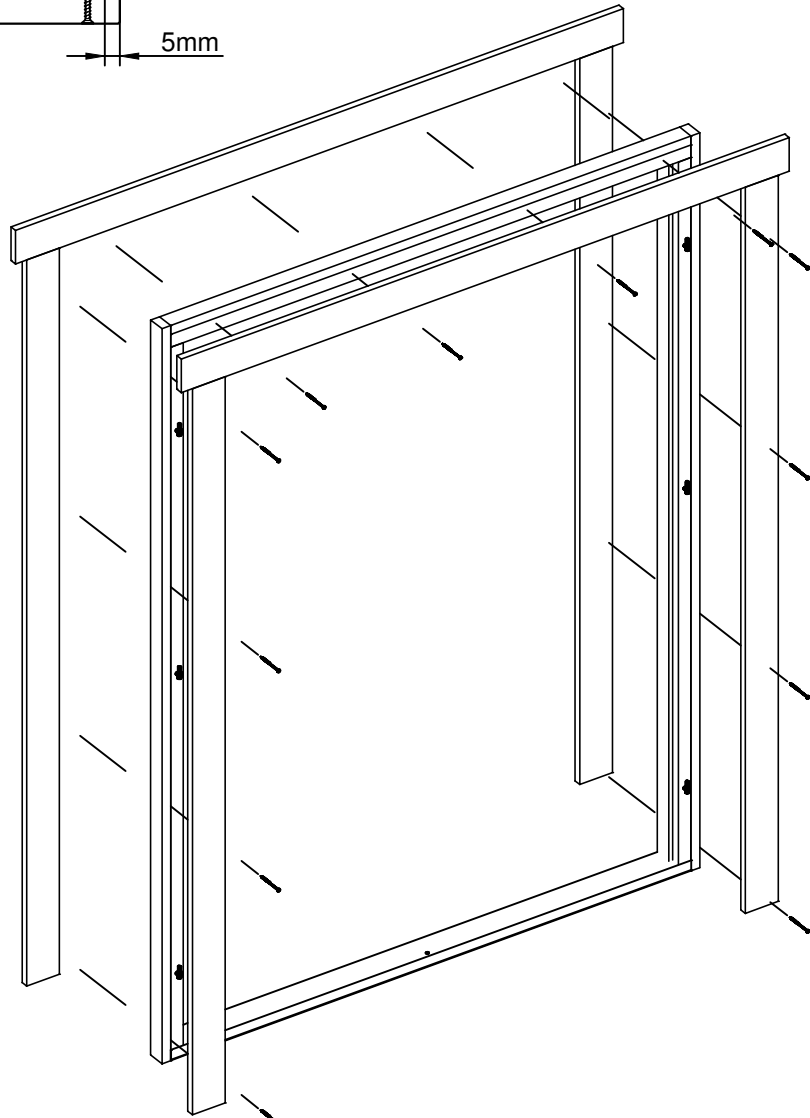
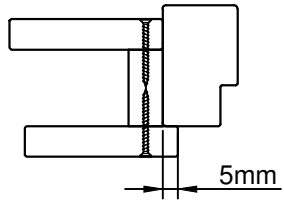

3.5x45



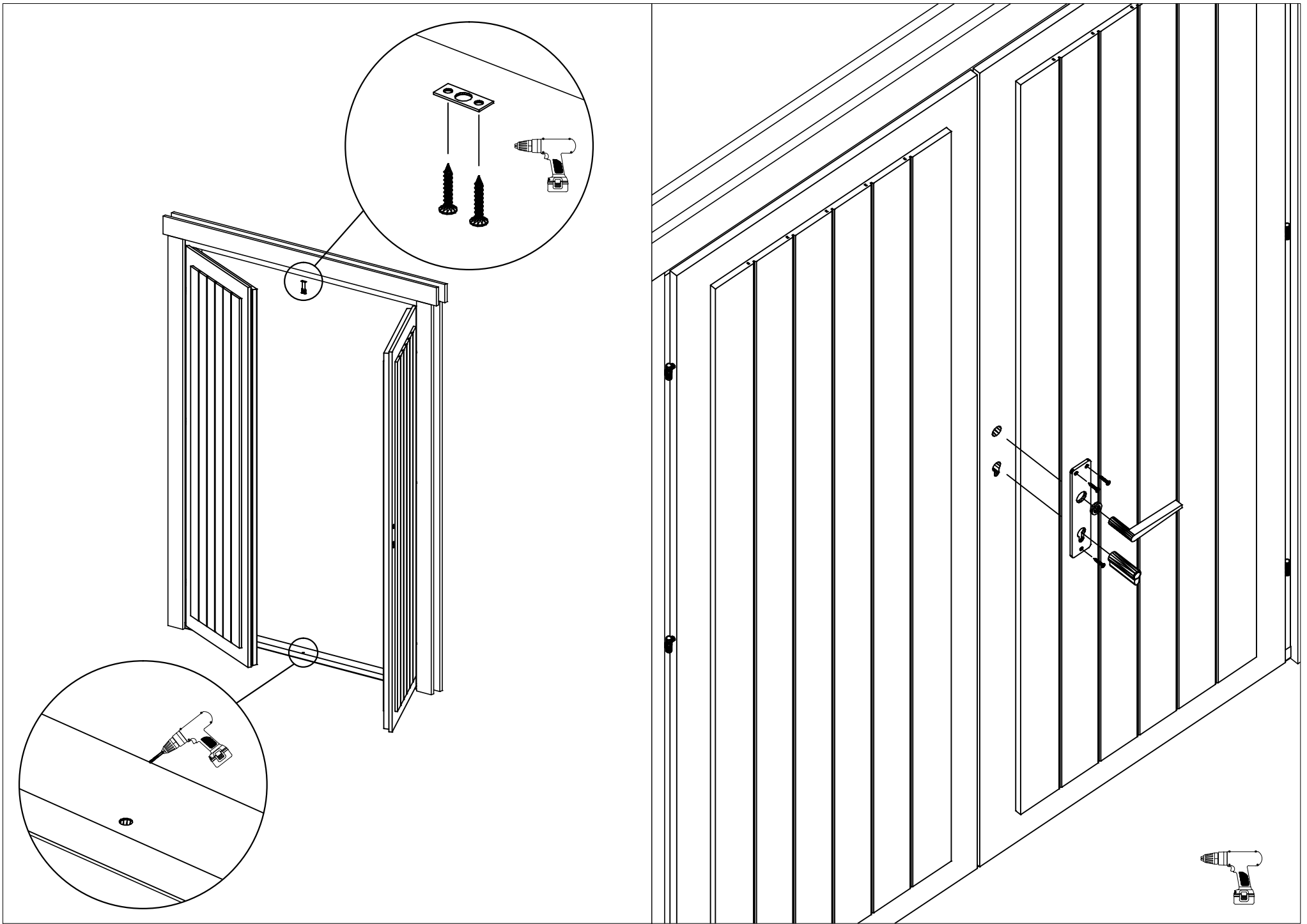



# Vihmaliist / Head flashing / Regenschutz

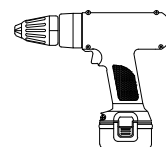
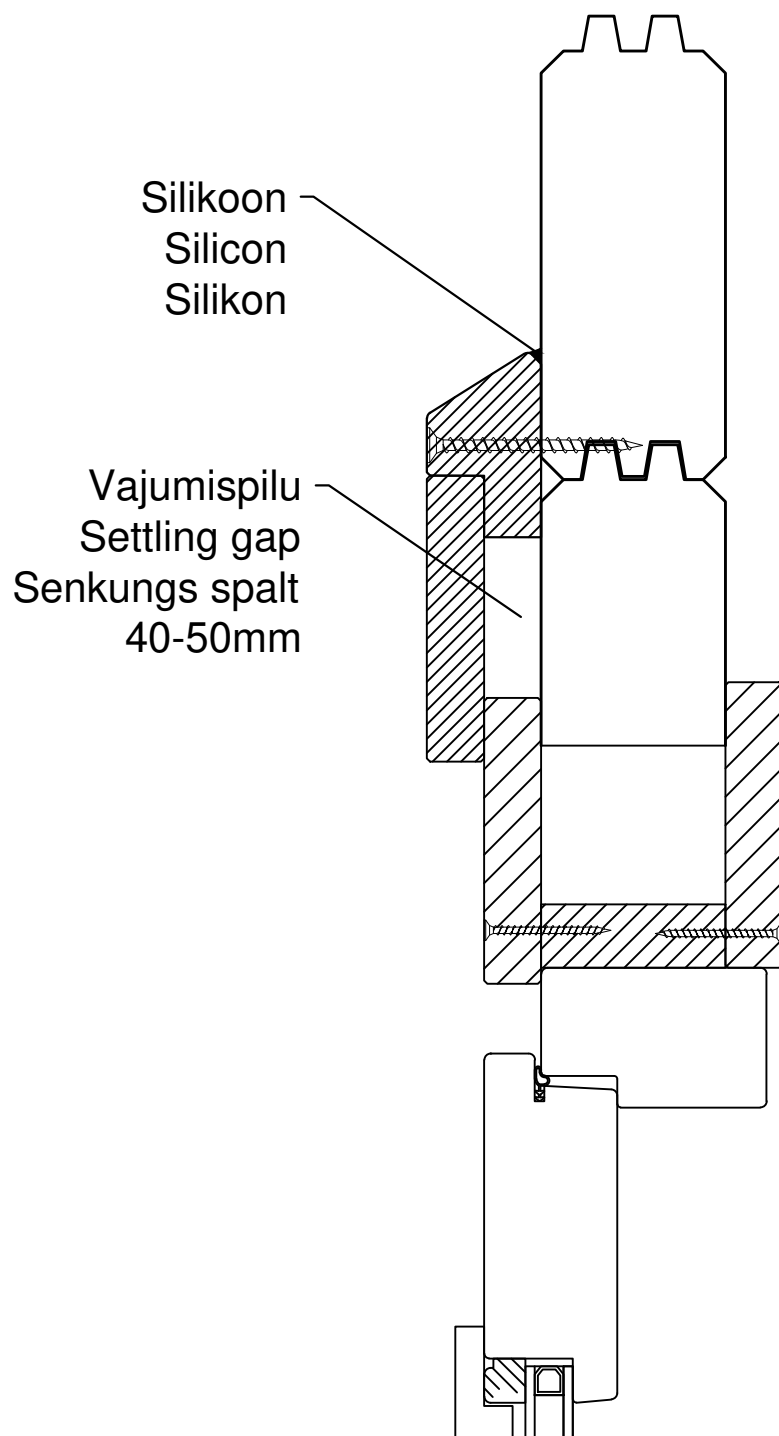

NB!

- Monteerida juhul kui ese on välja toodud maja spetsifikatsioonis!
- Install only if the item is listed in the house specification!
- Nur montieren wenn die Leiste in der Teilleiste gezeigt ist!

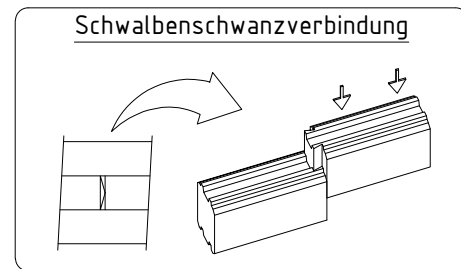
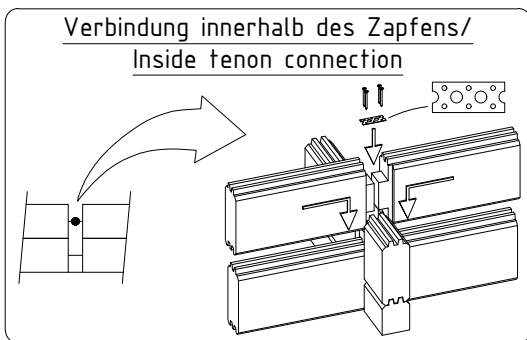
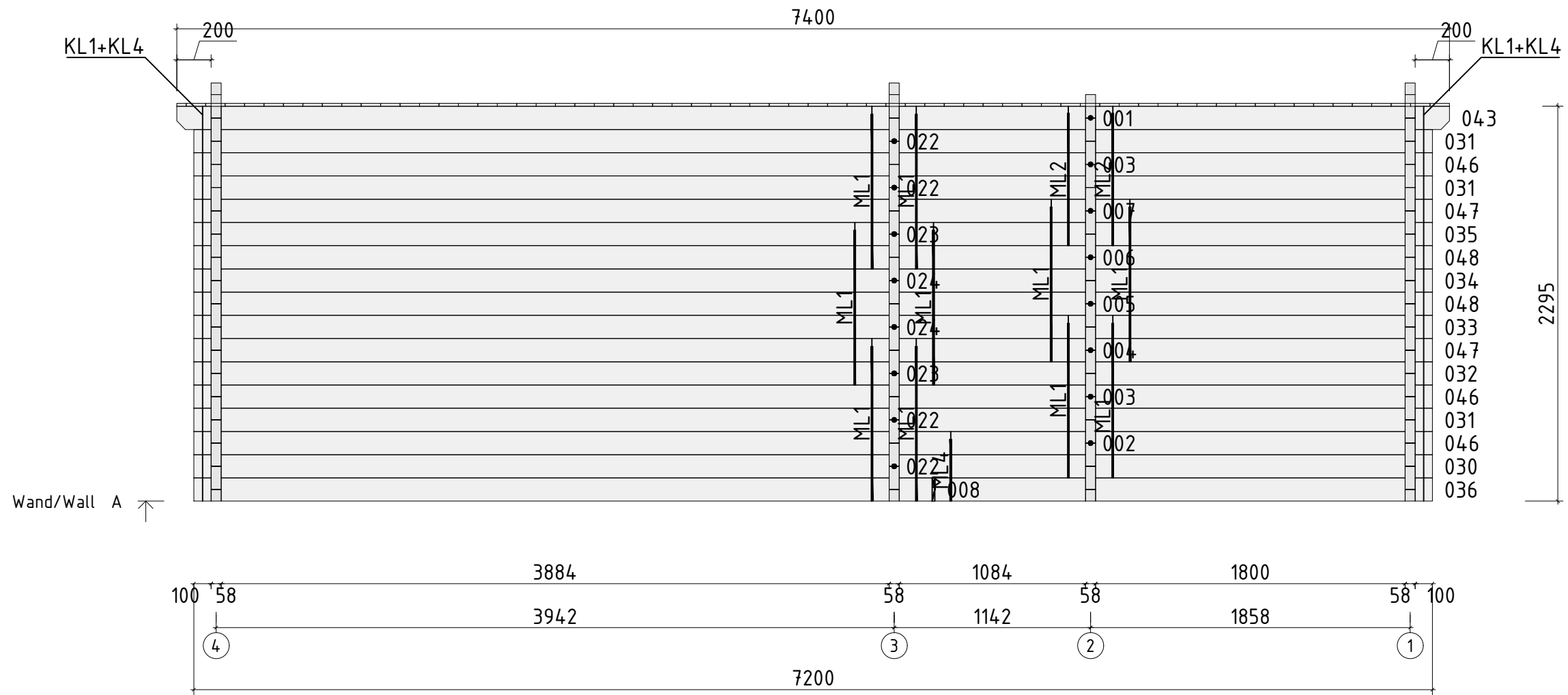

Name	Malaga 2 420x720_58		
Zeichnung/Drawing	WAND/WALL A		
Profil/Profile	5.8x13.5	Datum/Date	11.04.2022

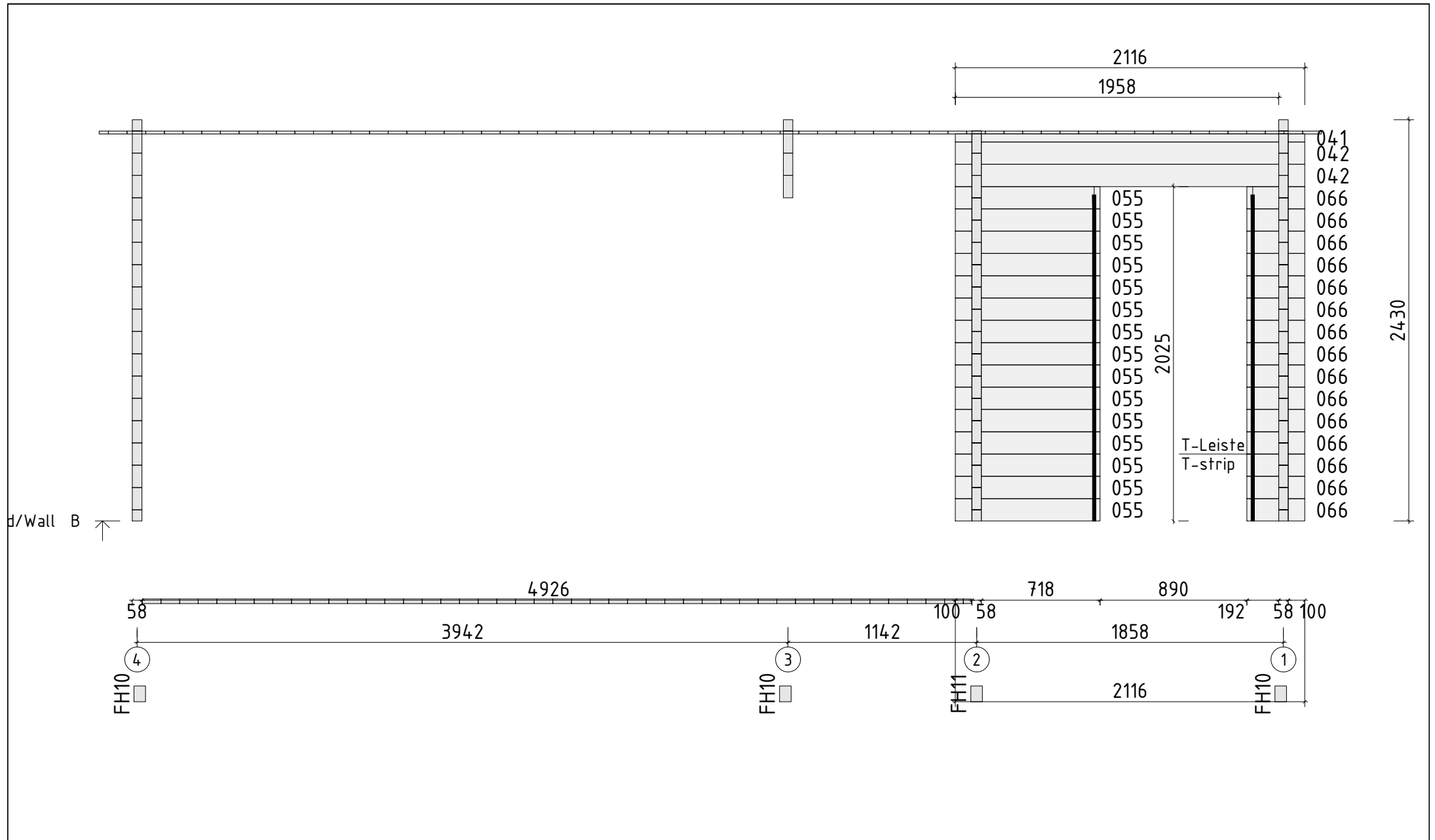

Name	Malaga 2 420x720_58		
Zeichnung/Drawing	WAND/WALL B		
Profil/Profile	5.8x13.5	Datum/Date	11.04.2022

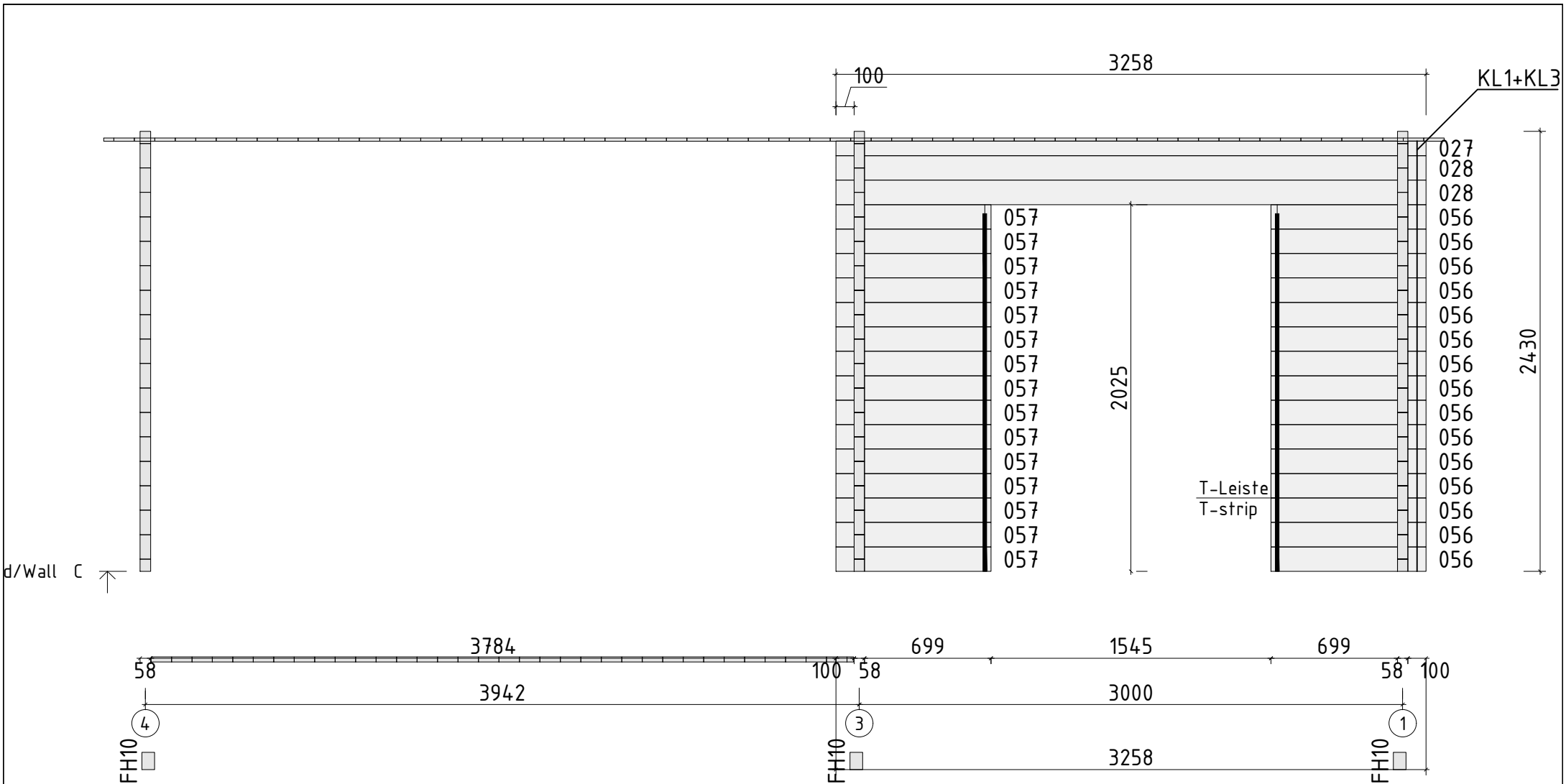

Name	Malaga 2 420x720_58		
Zeichnung/Drawing	WAND/WALL C		
Profil/Profile	5.8x13.5	Datum/Date	11.04.2022



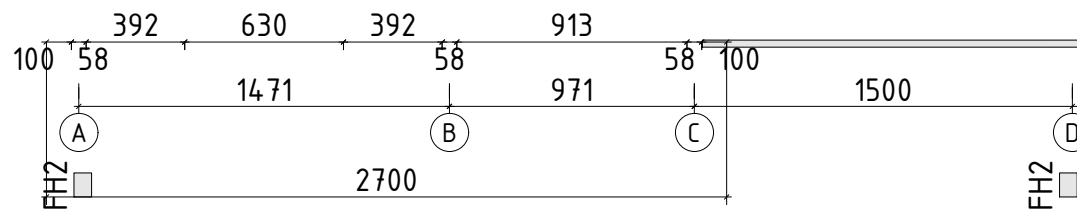
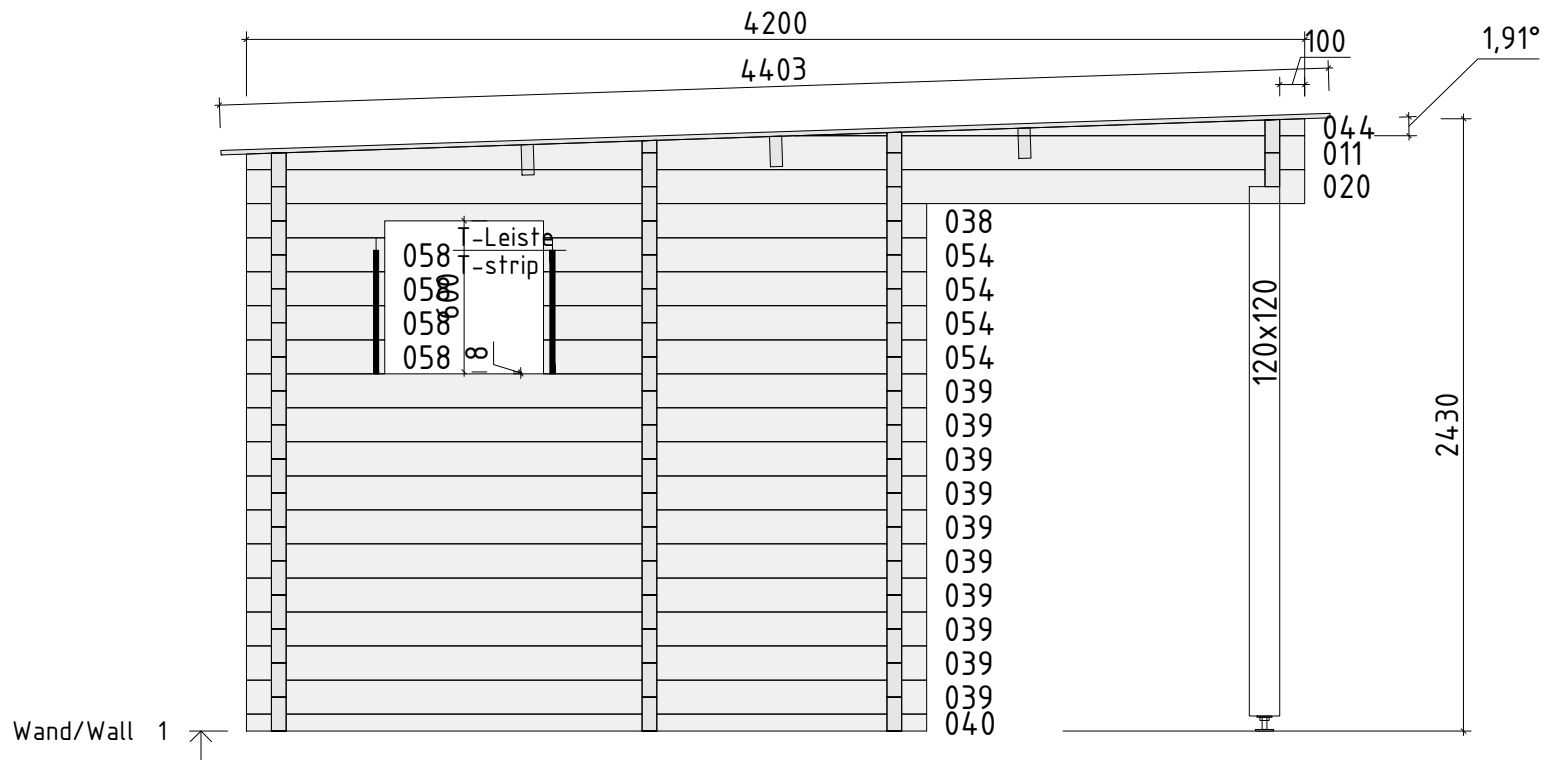

Name	Malaga 2 420x720_58		
Zeichnung/Drawing	WAND/WALL 1		
Profil/Profile	5.8x13.5	Datum/Date	11.04.2022

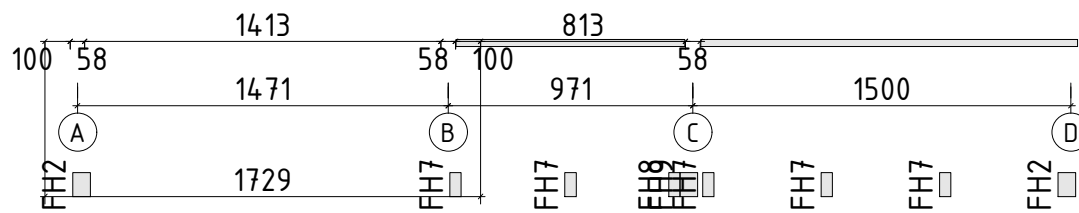
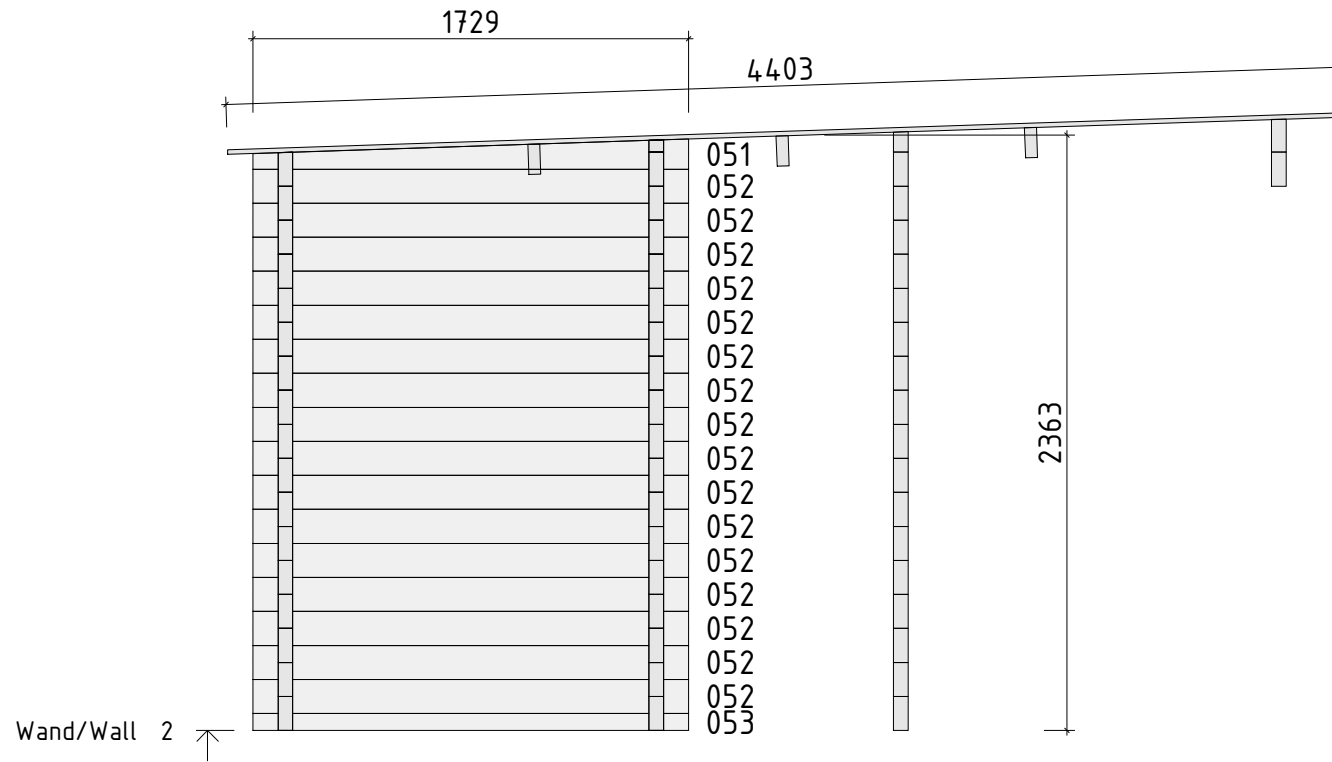

Name	Malaga 2 420x720_58		
Zeichnung/Drawing	WAND/WALL 2		
Profil/Profile	5.8x13.5	Datum/Date	11.04.2022





