

Name	Murcia 475x1120/70		
Zeichnung/Drawing	3D		
Maßstab/Scale	1:50	Profil/Profile	7.0x13.5
		Datum/Date	25.11.2020

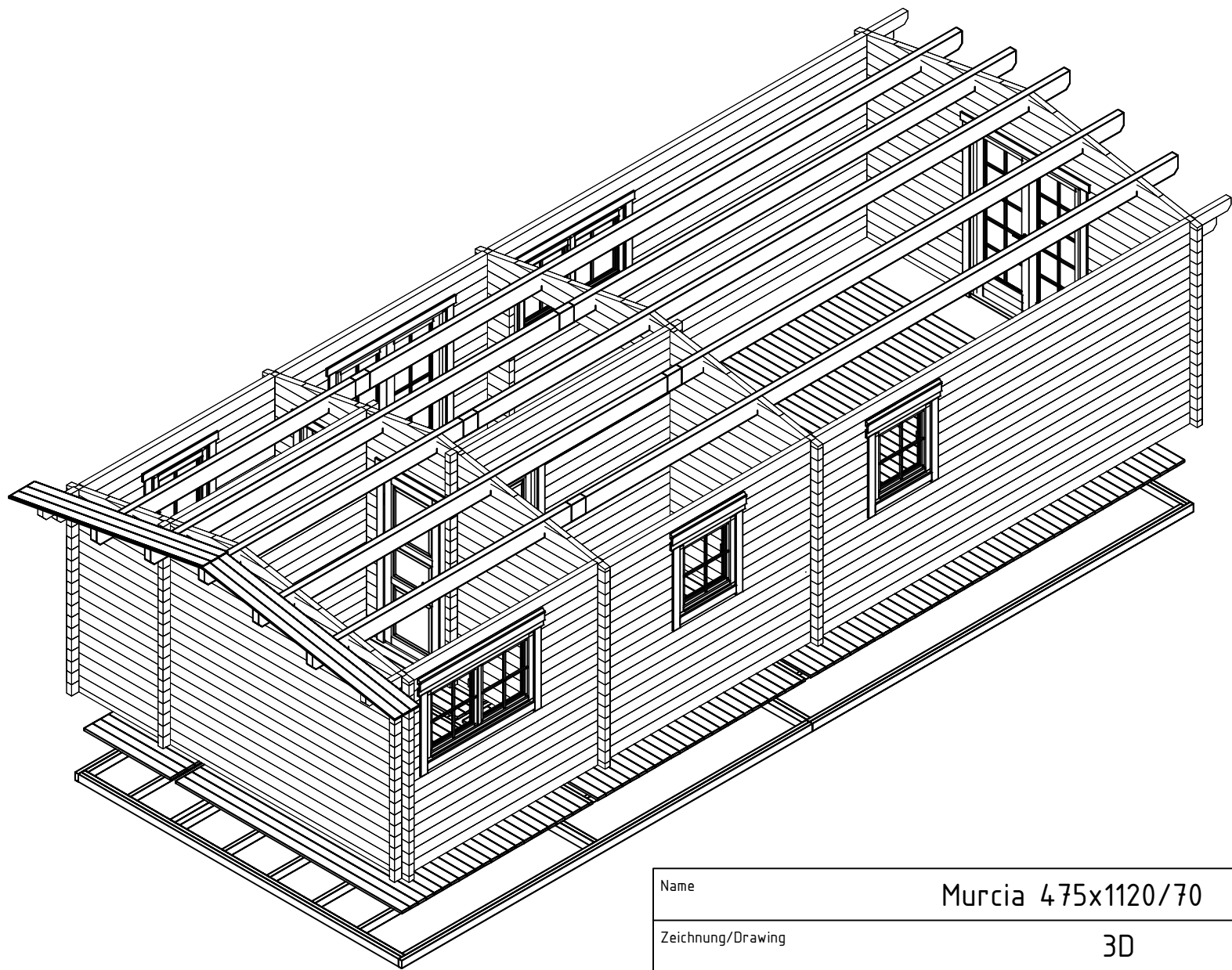

Name	Murcia 475x1120/70		
Zeichnung/Drawing	3D		
Maßstab/Scale	1:50	Profil/Profile	7.0x13.5
		Datum/Date	25.11.2020

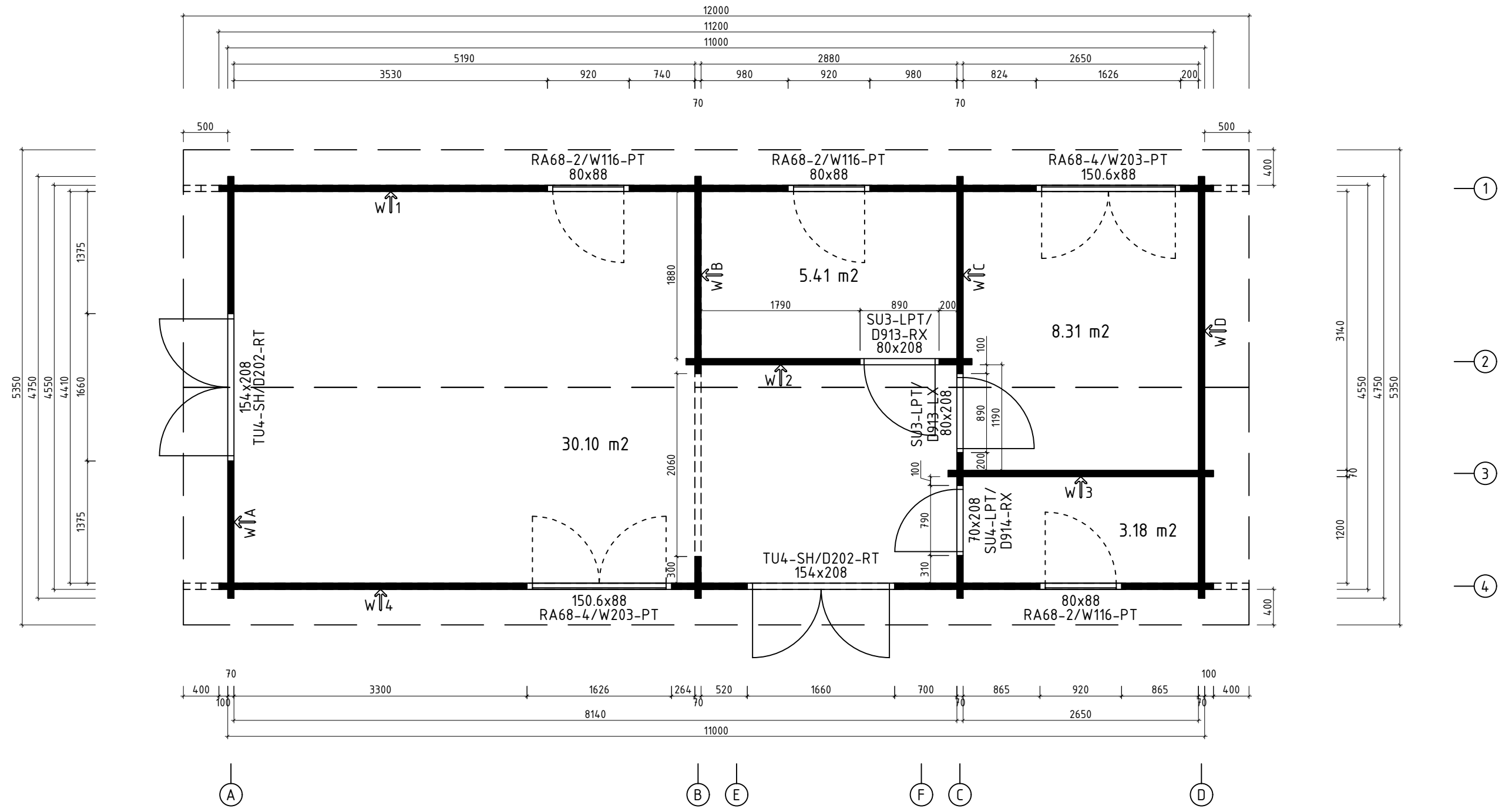

Q5 – Qualitätsklasse für Fenster und Türen

*Fenster und Türen sind mit Sprossen/
Windows and doors are with muntins

Name	Murcia 475x1120/70		
Zeichnung/Drawing	Grundplan; Plan		
Maßstab/Scale	1:50	Profil/Profile	7.0x13.5
		Datum/Date	25.11.2020

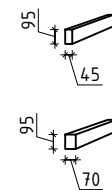
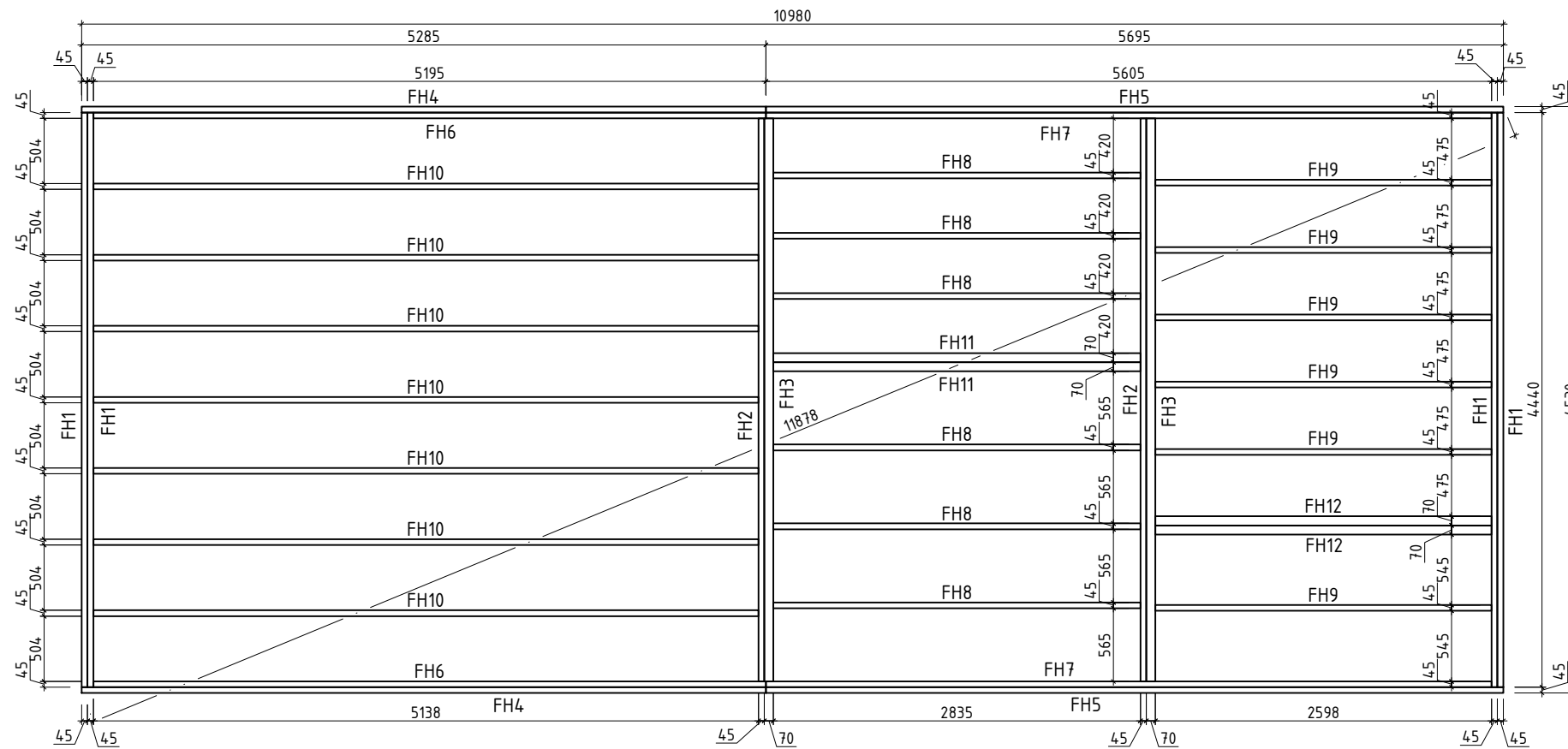

Name	Murcia 475x1120/70		
Zeichnung/Drawing	Lagerholzplan; Foundation beams		
Maßstab/Scale	1:50	Profil/Profile	7.0x13.5
		Datum/Date	25.11.2020

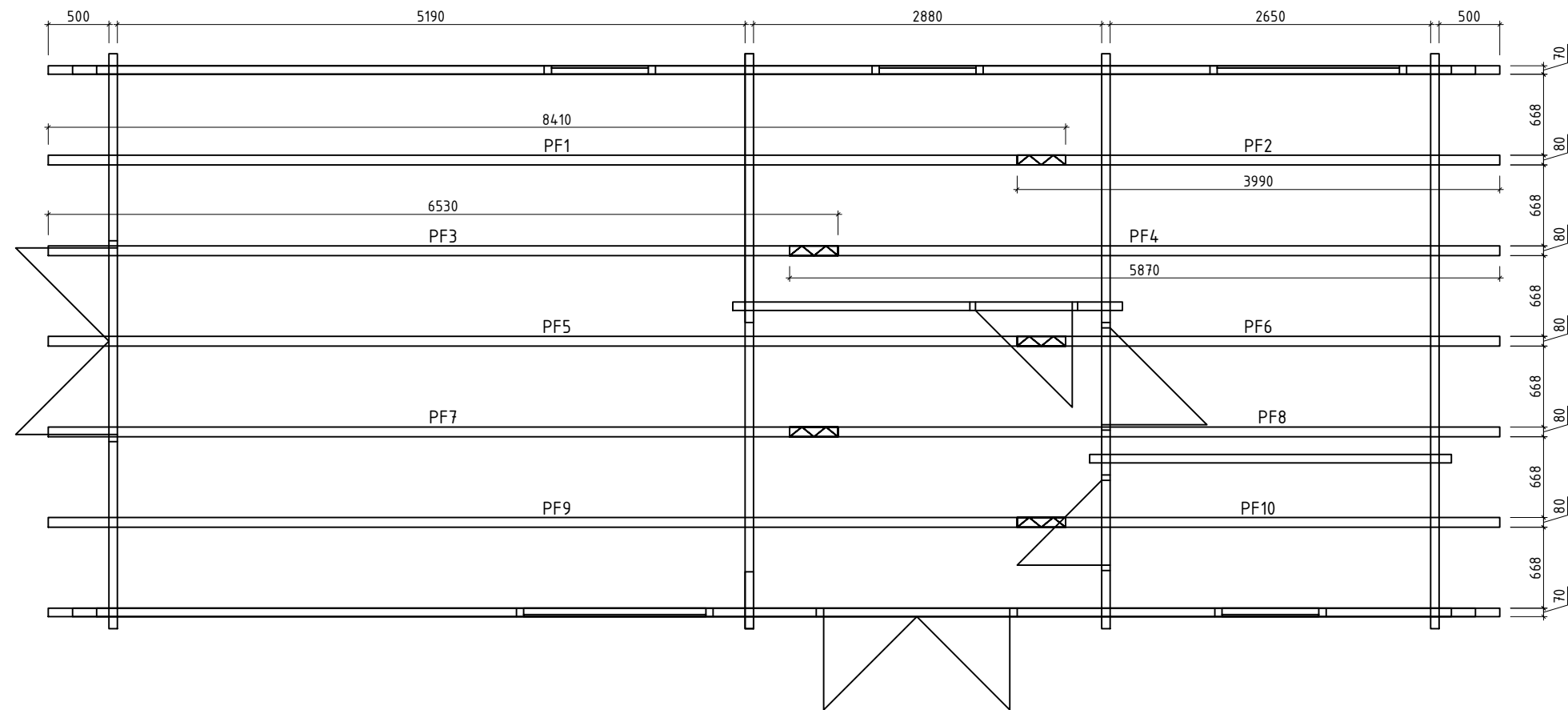



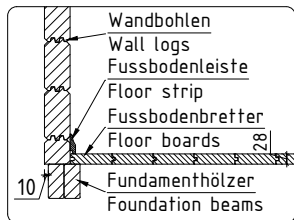
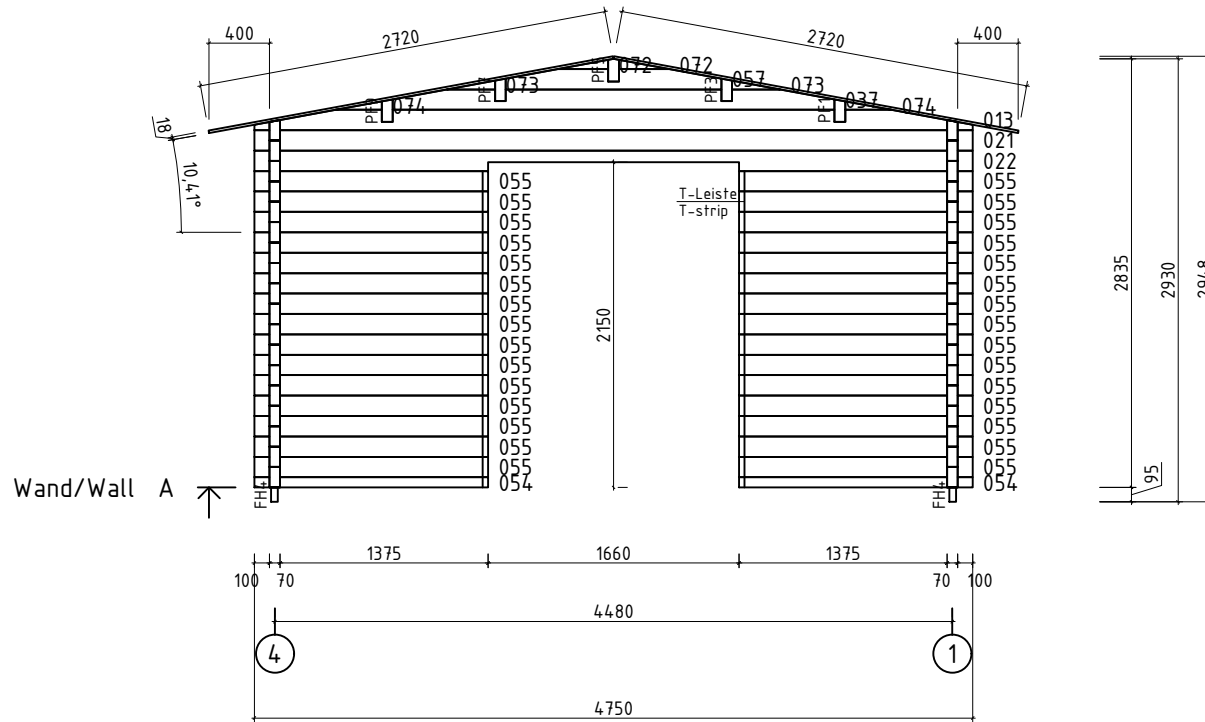
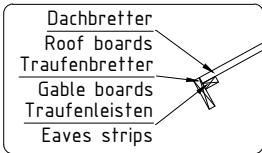

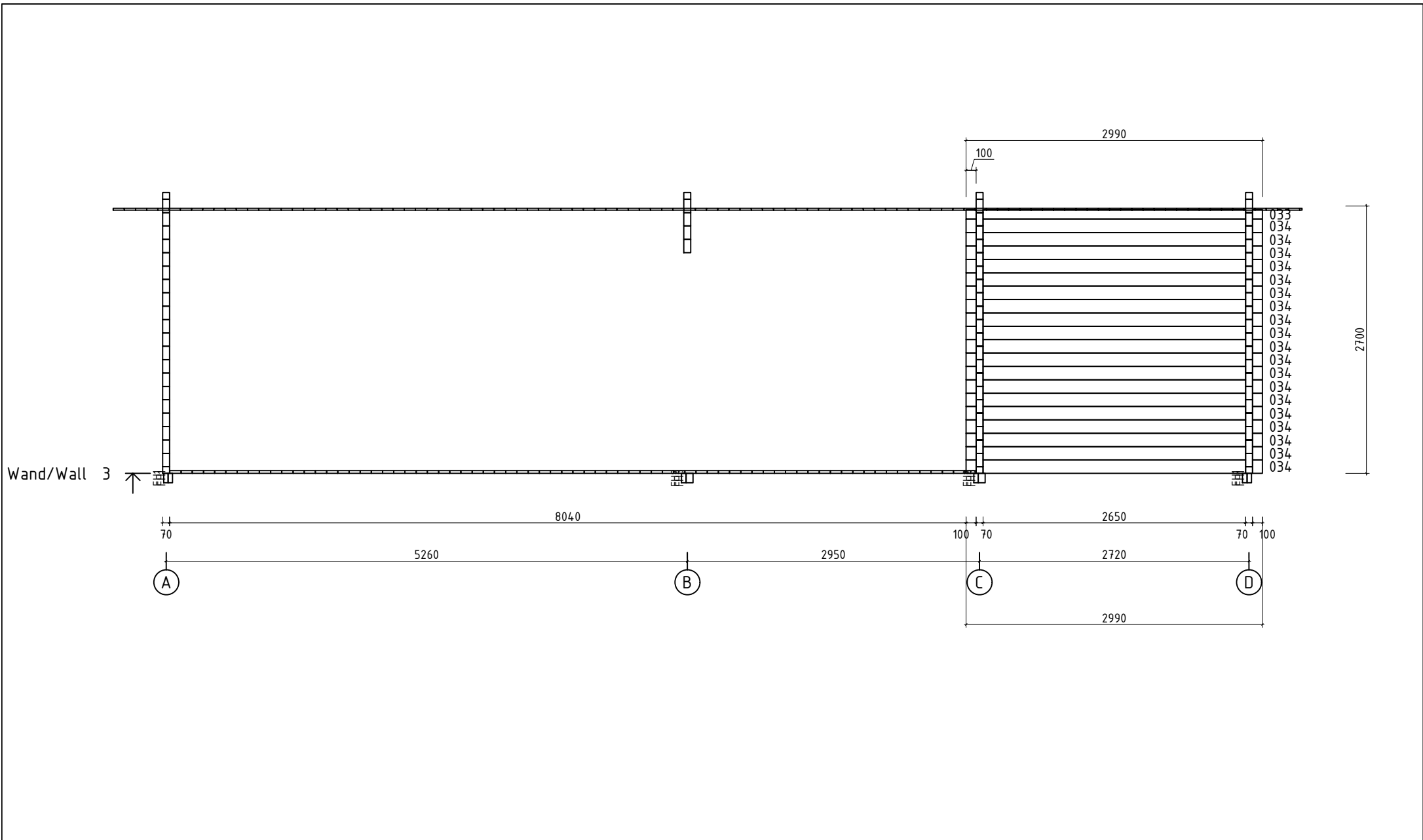

Name	Murcia 475x1120/70		
Zeichnung/Drawing	Pfetten; Purlins		
Maßstab/Scale	1:50	Profil/Profile	7.0x13.5
		Datum/Date	25.11.2020



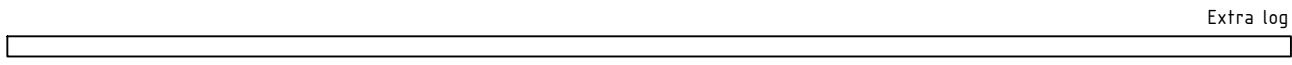
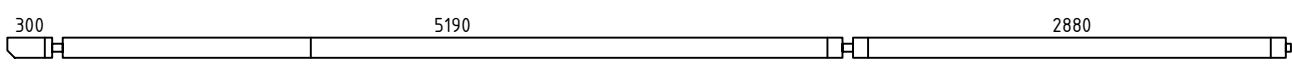
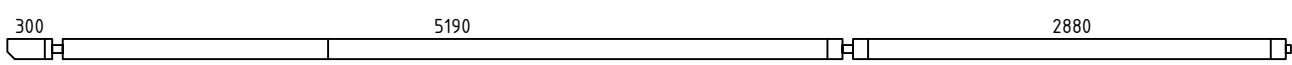
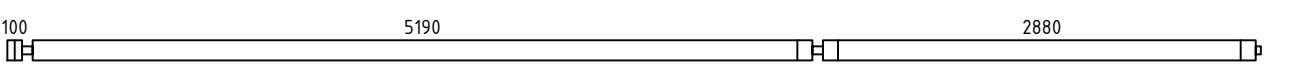
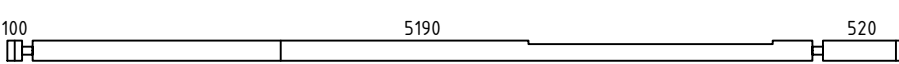
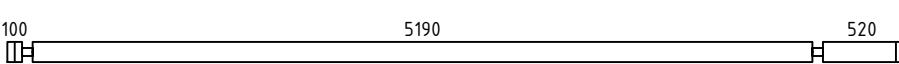

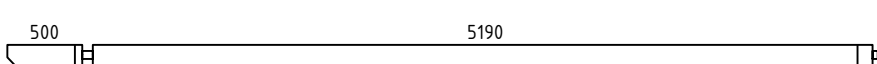
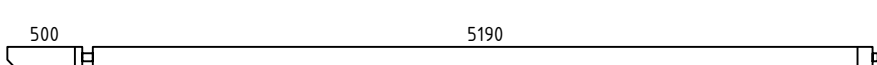
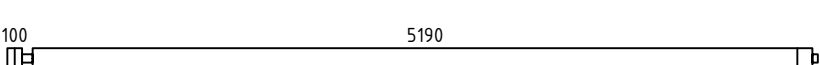
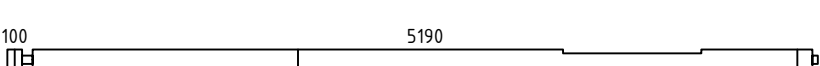
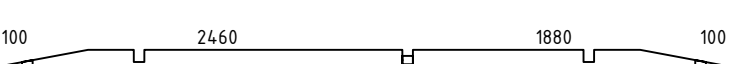
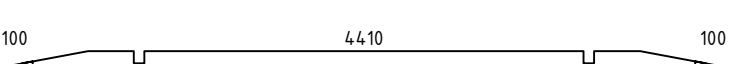

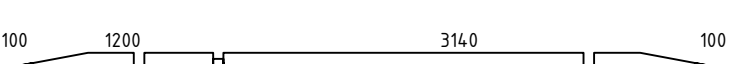
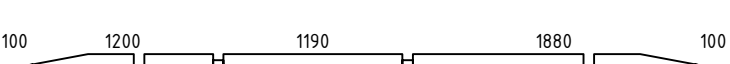
Name	Murcia 475x1120/70		
Zeichnung/Drawing	WAND/WALL A		
Maßstab/Scale	1:50	Profil/Profile	7.0x13.5
		Datum/Date	25.11.2020

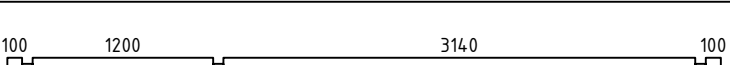
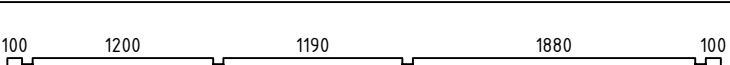
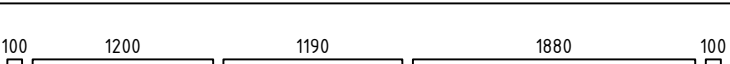
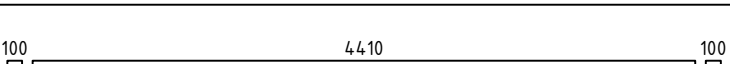
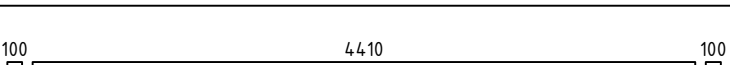
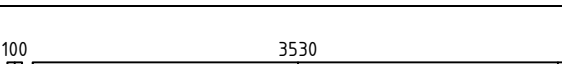

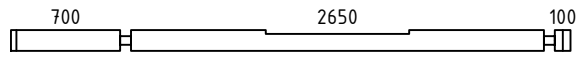
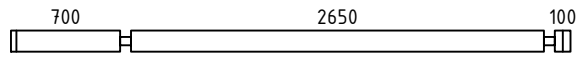
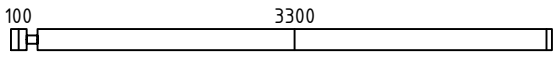
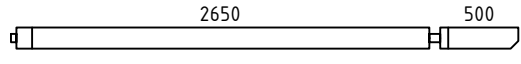
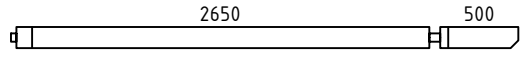
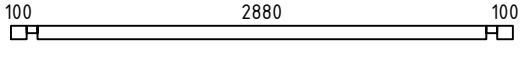
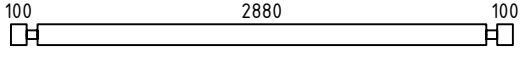
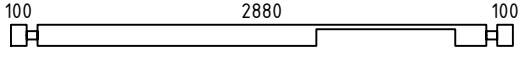
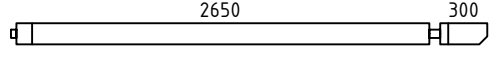
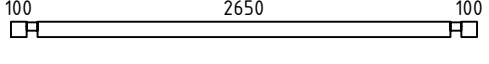
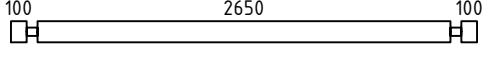
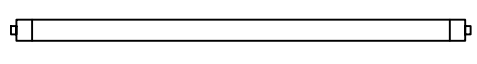
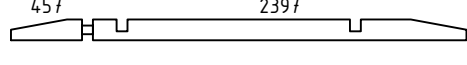
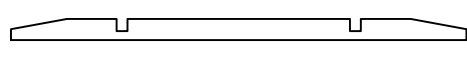
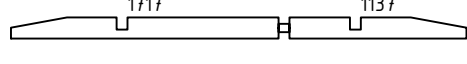
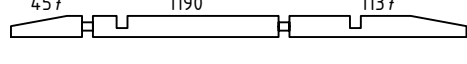
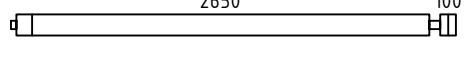
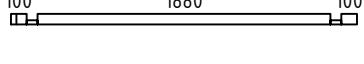
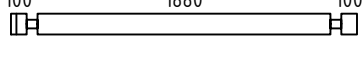
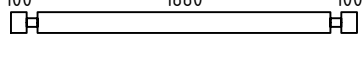
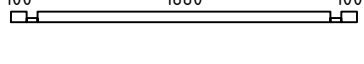
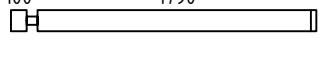
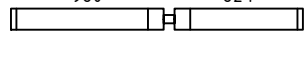
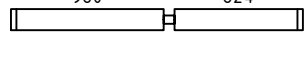
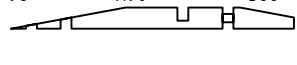

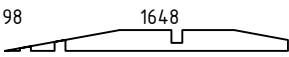
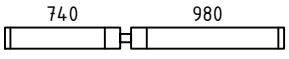
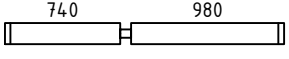
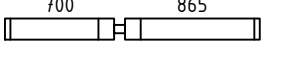
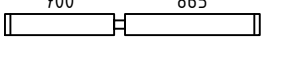
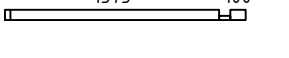
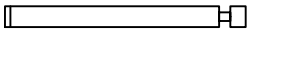
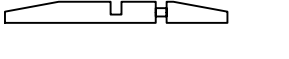
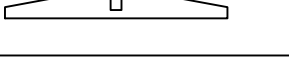
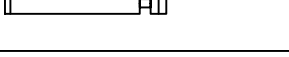
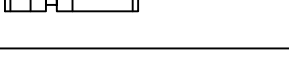
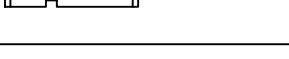
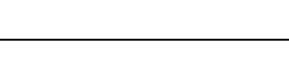
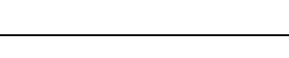
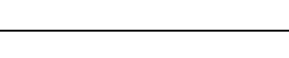
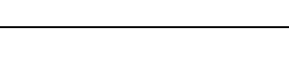
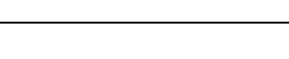
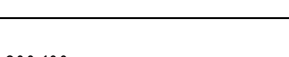
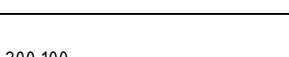

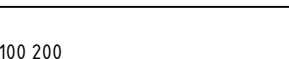
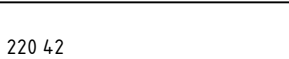

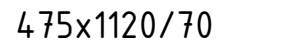

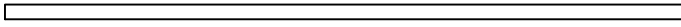
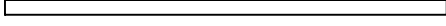

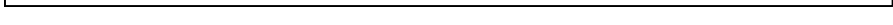
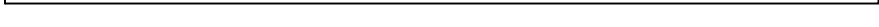



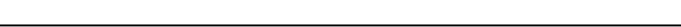

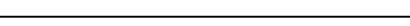
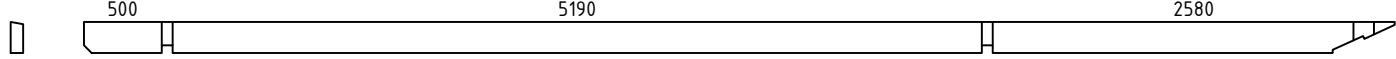
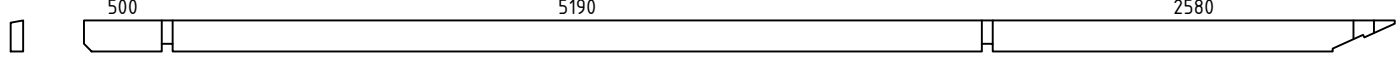
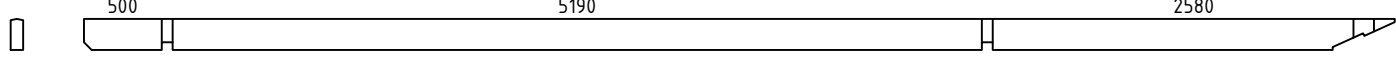
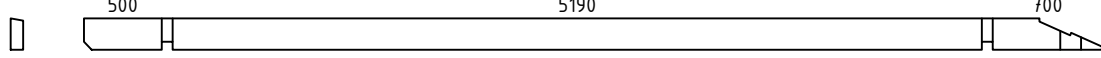
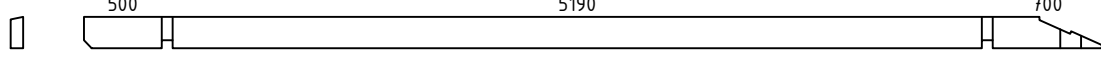
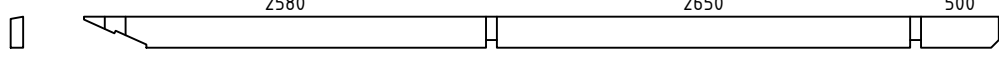
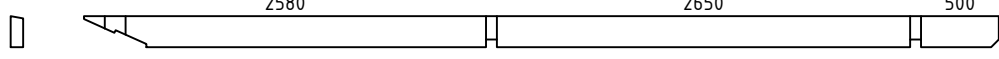
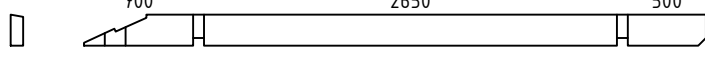
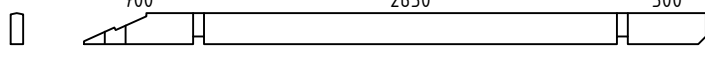
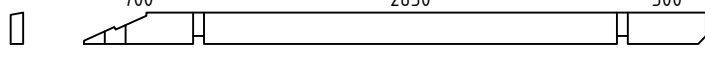



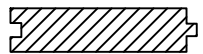
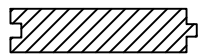
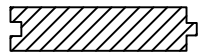
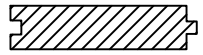



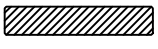

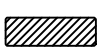
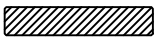

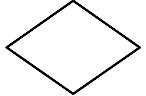

Name	Murcia 475x1120/70		
Zeichnung/Drawing	WAND/WALL 3		
Maßstab/Scale	1:50	Profil/Profile	7.0x13.5
		Datum/Date	25.11.2020





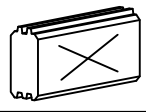

Pos	Teileliste/Specification Murcia 475x1120/70	Stck. Pcs.	Profil Profile (mm)	Länge Length (mm)
	Achtung! Die Giebelbohlen können teilweise schon vormontiert sein! Bitte beachten - diese erscheinen nicht ganz so wie in der Teileliste beschrieben.			
	Notice! The gable pieces can be partly pre-assembled! Please notice - those differ from the description given in the specification list.			
000		1	70x135	8545
001		1	70x135	8545
002		1	70x135	8545
003		4	70x135	8345
004		1	70x135	5950
005		8	70x135	5950
006		4	70x135	5805
007		1	70x135	5805
008		1	70x135	5795
009		1	70x135	5795
010		4	70x135	5395
011		1	70x135	5395
012		1	70x135	4750
013		1	70x135	4750
014		1	70x135	4750
015		1	70x135	4750
016		1	70x135	4750
017		17	70x135	4750
018		1	70x68	4750
019		1	70x135	4750
020		1	70x135	4750
021		1	70x135	4750
022		1	70x135	4750
023		7	70x135	3700
Kood	Murcia 475x1120/70	Materjal		Leht 1/7

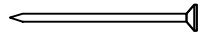
Pos	Teileliste/Specification Murcia 475x1120/70	Stck Pcs.	Profil Profile (mm)	Länge Length (mm)
024		1	70x135	3590
025		8	70x135	3590
026		7	70x135	3470
027		1	70x135	3255
028		1	70x135	3255
029		1	70x88	3220
030		4	70x135	3220
031		1	70x135	3220
032		2	70x135	3055
033		1	70x98	2990
034		19	70x135	2990
035		2	70x135	2950
036		1	70x135	2923
037		1	70x135	2923
038		1	70x135	2923
039		1	70x135	2923
040		4	70x135	2855
041		1	70x68	2220
042		15	70x135	2220
043		16	70x135	2220
044		1	70x68	2220
045		15	70x135	1960
046		1	70x135	1874
047		6	70x135	1874
048		1	70x135	1816
Kood	Murcia 475x1120/70	Materjal		Leht 2/7

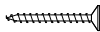
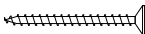
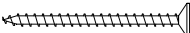
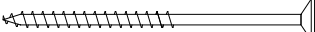
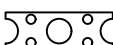
Pos	Teileliste/Specification Murcia 475x1120/70	Stck Pcs.	Profil Profile (mm)	Länge Length (mm)
049		1	70x135	1816
050		2	70x135	1790
051		5	70x135	1790
052		1	70x135	1635
053		6	70x135	1635
054		2	70x68	1545
055		30	70x135	1545
056		1	70x135	1427
057		1	70x135	1427
058		7	70x135	1035
059		1	70x135	854
060		6	70x135	854
061		1	70x68	480
062		15	70x135	480
063		9	70x135	470
064		4	70x135	470
065		3	70x135	470
066		1	70x68	470
067		7	70x135	370
068		15	70x135	370
069		1	70x68	370
070		15	70x135	370
071		2	70x61	332
072		6	70x61	332
073		6	70x59	319
Kood	Murcia 475x1120/70	Materjal		Leht 3/7

Pos	Teileliste/Specification Murcia 475x1120/70		Stck Pcs.	Profil Profile (mm)	Länge Length (mm)
074			8	70x56	306
FH3		FUNDAMENTHOLZ (imprägniert) - FOUNDATION BEAM (impregnated)	2	70x95	4350
FH11		FUNDAMENTHOLZ (imprägniert) - FOUNDATION BEAM (impregnated)	2	70x95	2835
FH12		FUNDAMENTHOLZ (imprägniert) - FOUNDATION BEAM (impregnated)	2	70x95	2597
FH5		FUNDAMENTHOLZ (imprägniert) - FOUNDATION BEAM (impregnated)	2	45x95	5695
FH7		FUNDAMENTHOLZ (imprägniert) - FOUNDATION BEAM (impregnated)	2	45x95	5605
FH4		FUNDAMENTHOLZ (imprägniert) - FOUNDATION BEAM (impregnated)	2	45x95	5285
FH6		FUNDAMENTHOLZ (imprägniert) - FOUNDATION BEAM (impregnated)	2	45x95	5195
FH10		FUNDAMENTHOLZ (imprägniert) - FOUNDATION BEAM (impregnated)	7	45x95	5138
FH1		FUNDAMENTHOLZ (imprägniert) - FOUNDATION BEAM (impregnated)	4	45x95	4440
FH2		FUNDAMENTHOLZ (imprägniert) - FOUNDATION BEAM (impregnated)	2	45x95	4350
FH8		FUNDAMENTHOLZ (imprägniert) - FOUNDATION BEAM (impregnated)	6	45x95	2835
FH9		FUNDAMENTHOLZ (imprägniert) - FOUNDATION BEAM (impregnated)	6	45x95	2597
PF1		PFETTEN - PURLINS	1	80x200	8410
PF9		PFETTEN - PURLINS	1	80x200	8410
PF5		PFETTEN - PURLINS	1	80x200	8410
PF3		PFETTEN - PURLINS	1	80x200	6530
PF7		PFETTEN - PURLINS	1	80x200	6530
PF8		PFETTEN - PURLINS	1	80x200	5870
PF4		PFETTEN - PURLINS	1	80x200	5870
PF2		PFETTEN - PURLINS	1	80x200	3990
PF6		PFETTEN - PURLINS	1	80x200	3990
PF10		PFETTEN - PURLINS	1	80x200	3990
	DACHBRETTER - ROOF BOARDS		214+3	113x18	2720
	FUSSBODENBRETTER - FLOOR BOARDS		46+2	113x28	4405
Kood	Murcia 475x1120/70		Materjal		Leht 4/7

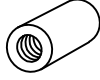
Pos	Teileliste/Specification Murcia 475x1120/70		Stck Pcs.	Profil Profile (mm)	Länge Length (mm)
	FUSSBODENBRETTER - FLOOR BOARDS		24	113x28	3135
	FUSSBODENBRETTER - FLOOR BOARDS		26	113x28	2455
	FUSSBODENBRETTER - FLOOR BOARDS		26	113x28	1875
	FUSSBODENBRETTER - FLOOR BOARDS		24	113x28	1195
	ABDECKLEISTEN für Decke (innen) - COVER STRIPS for ceiling (inside)	 ✓		15x28	70,0 lfm/rm
	FUSSBODENLEISTEN - FLOOR STRIPS	 ✓		14x55	58,0 lfm/rm
G02-1	GIEBELBRETTER - GABLE BOARDS 18x120	 10,4° ✓	4	18x120	2800
G01-1	GIEBELBRETTER - GABLE BOARDS 18x95	 10,4° ✓	4	18x95	2800
G06-1	GIEBELDECKLEISTEN - GABLE COVER STRIPS 18x58	 ✓	4	18x58	2800
G08-1	GIEBELLEISTEN - GABLE STRIPS 18x58	 10,4° ✓	4	18x58	2800
T01-1	TRAUFENBRETTER - EAVES BOARDS 18x95		4	18x95	6000
T06-1	TRAUFENLEISTEN - EAVES STRIPS 18x40	 ✓		18x40	25,0 lfm/rm
GS	GIEBELSEGMENT - GABLE DIAMOND		2		
TL70-1	T-LEISTEN - T-STRIPS 70		10	45x70	895
TL70-2	T-LEISTEN - T-STRIPS 70		2	45x70	1975
TL70-3	T-LEISTEN - T-STRIPS 70		6	45x70	2045
TL70-4	T-LEISTEN - T-STRIPS 70		2	45x70	2110
ML1	Metallstange - Metal bar		1	D10	970
ML2	Metallstange - Metal bar		2	D10	900
ML3	Metallstange - Metal bar		8	D10	630
ML4	Metallstange - Metal bar		4	D10	500
ML5	Metallstange - Metal bar		8	D10	360
SH	SCHLAGHÖLZER - MOUNTING PIECES		3		
NG04	NÄGEL - NAILS 2.5x50 Dachbretter - Roof boards		1712		
NG05	NÄGEL - NAILS 2.5x60 Fussbodenbretter - Floor boards		1892		
Kood	Murcia 475x1120/70		Materjal		Leht 5/7

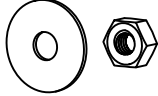
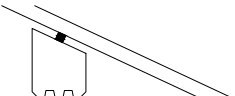
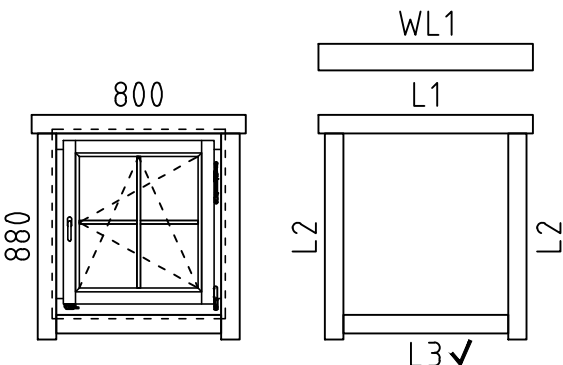
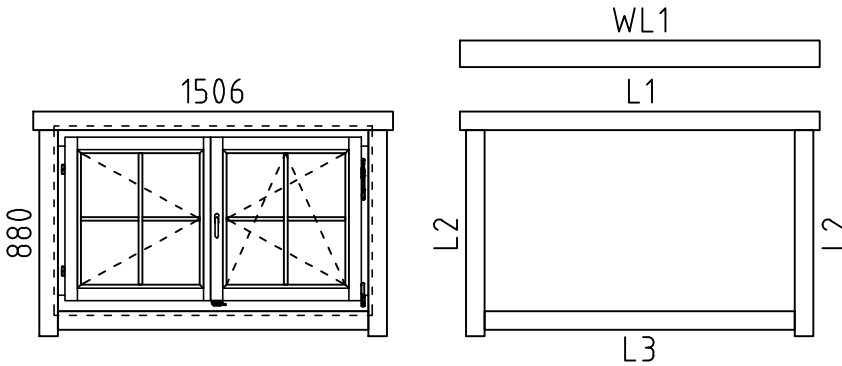
Pos	Teileliste/Specification Murcia 475x1120/70		Stck Pcs.	Profil Profile (mm)	Länge Length (mm)
SR32	Schrauben - Screws 3.0x30	Fussbodenleisten - Floor strips Traufenleisten - Eaves strips 40x18 Abdeckleisten - Cover strips		306	
SR37	Schrauben - Screws 3.5x45	Giebelbretter - Gable boards Giebeldeckleiste - Gable cover strips Giebelsegment - Gable diamond Traufenbretter - Eaves boards Tür/Fensterleisten - Door/Window strips Verbindungsstreifen - Connecting strips		474	
SR44	Schrauben - Screws 4.0x60	Wasserleiste - Rain strip WL1		25	
SR57	Schrauben - Screws 5.0x100	Fundamenthölzer - Foundation beams		156	
VS	Verbindungsstreifen für verbinden der Wandbohlen - Connecting strip for connecting the wall parts			15	
KL1	Gewindestange - Threaded Rod M8			4	2000
KL2	Gewindestange - Threaded Rod M8			4	460
KV M UT M8	Mutter - Nut M8			8	
KV S EIB M8X25	U-Scheibe - Washer M8 Ø25			8	
KV MU TJ M8	Befestigungsmutter - Fixing nut M8			4	
KL-1	Gewindestange - Threaded rod M12- für die Pfetten - for purlins			10	200
MUT28	Mutter - Nut M12 U-Scheibe - Washer Ø40- für die Pfetten - for purlins			20	
DBA ND-1	DICHTUNGSBAND (letzte Bohlenkranz Seitenwänder) - SEAL TAPE (upper log on sidewalls)				24,5 lfm/rm
	<p>FENSTER/WINDOW <u>Q5</u> W5-S70P-04T-08000880</p>  <p style="text-align: right;">RA68-2 / W116-PT</p> <p>L1 18x90 L=1040mm 2x L2 18x90 L=1000mm 4x L3 18x90 L=800mm 2x ✓ WL1 36x129 L=1040mm 1x</p>		3		
	<p>FENSTER/WINDOW <u>Q5</u> W5-D70P-04T-15060880</p>  <p style="text-align: right;">RA68-4 / W203-PT</p> <p>L1 18x90 L=1745mm 2x L2 18x90 L=1000mm 4x L3 18x90 L=1505mm 2x ✓ WL1 36x129 L=1745mm 1x</p>		2		
Kood	Murcia 475x1120/70			Materjal	Leht 6/7

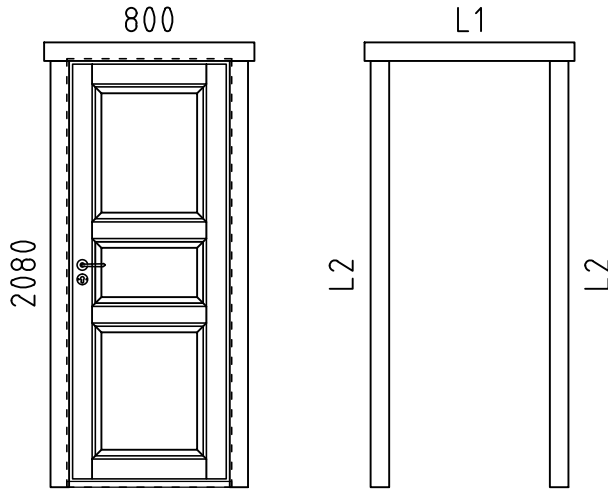
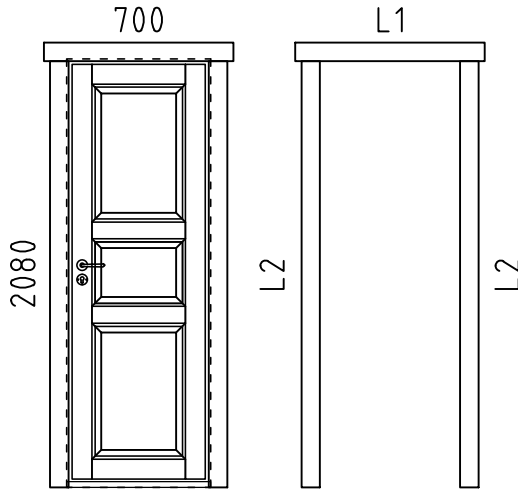
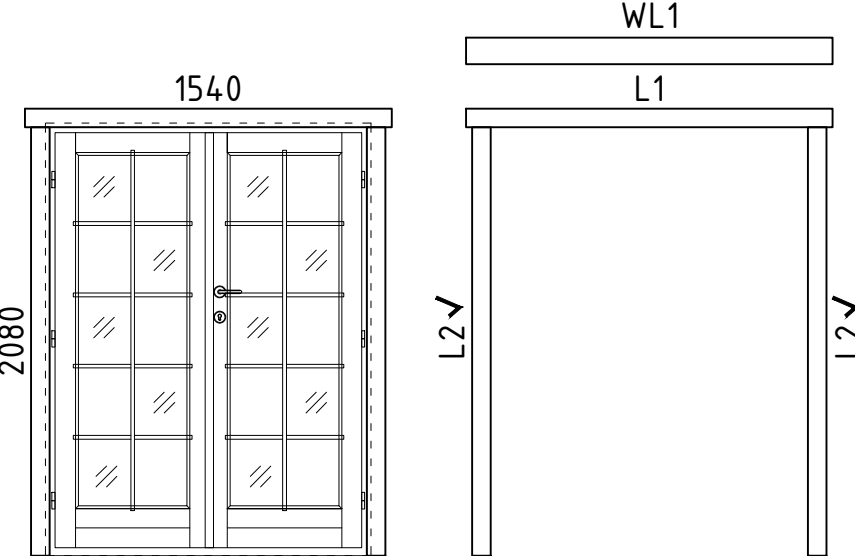
Pos	Teileliste/Specification Murcia 475x1120/70	Stck Pcs.	Profil Profile (mm)	Länge Length (mm)
	<p>TÜR/DOOR <u>Q5</u></p> <p style="text-align: right;">D0-I70R-XXX-08002080 D0-I70L-XXX-08002080</p>  <p>SU3_LPT / 1xD913-RX, 1xD913-LX</p> <p>L1 18x90 L=1020mm 2× L2 18x90 L=2070mm 4× ✓</p> <p>DIN 1xrechts; right handed, 1xlinks; left handed</p>	2		
	<p>TÜR/DOOR <u>Q5</u></p> <p style="text-align: right;">D0-I70R-XXX-07002080</p>  <p>SU4_LPT / D914-RX</p> <p>L1 18x90 L=920mm 2× L2 18x90 L=2070mm 4× ✓</p> <p>DIN rechts; right handed</p>	1		
	<p>TÜR/DOOR <u>Q5</u></p> <p style="text-align: right;">D5-D70R-01T-14251955</p>  <p>TU4-SH / D202-RT</p> <p>L1 18x90 L=1780mm 2* L2 18x90 L=2080mm 4*✓ WL1 36x129 L=1780mm 1*</p> <p>DIN rechts; right handed</p>	2		
	<p>✓ - Bitte selber anpassen (falls nötig)! / Cut into length on site (if needed)!</p>			
Kood	Murcia 475x1120/70	Materjal	Leht	7/7

Montageanleitung für T-Leisten / Installing the door and window supports / Tenderliistu paigaldusjuhend.

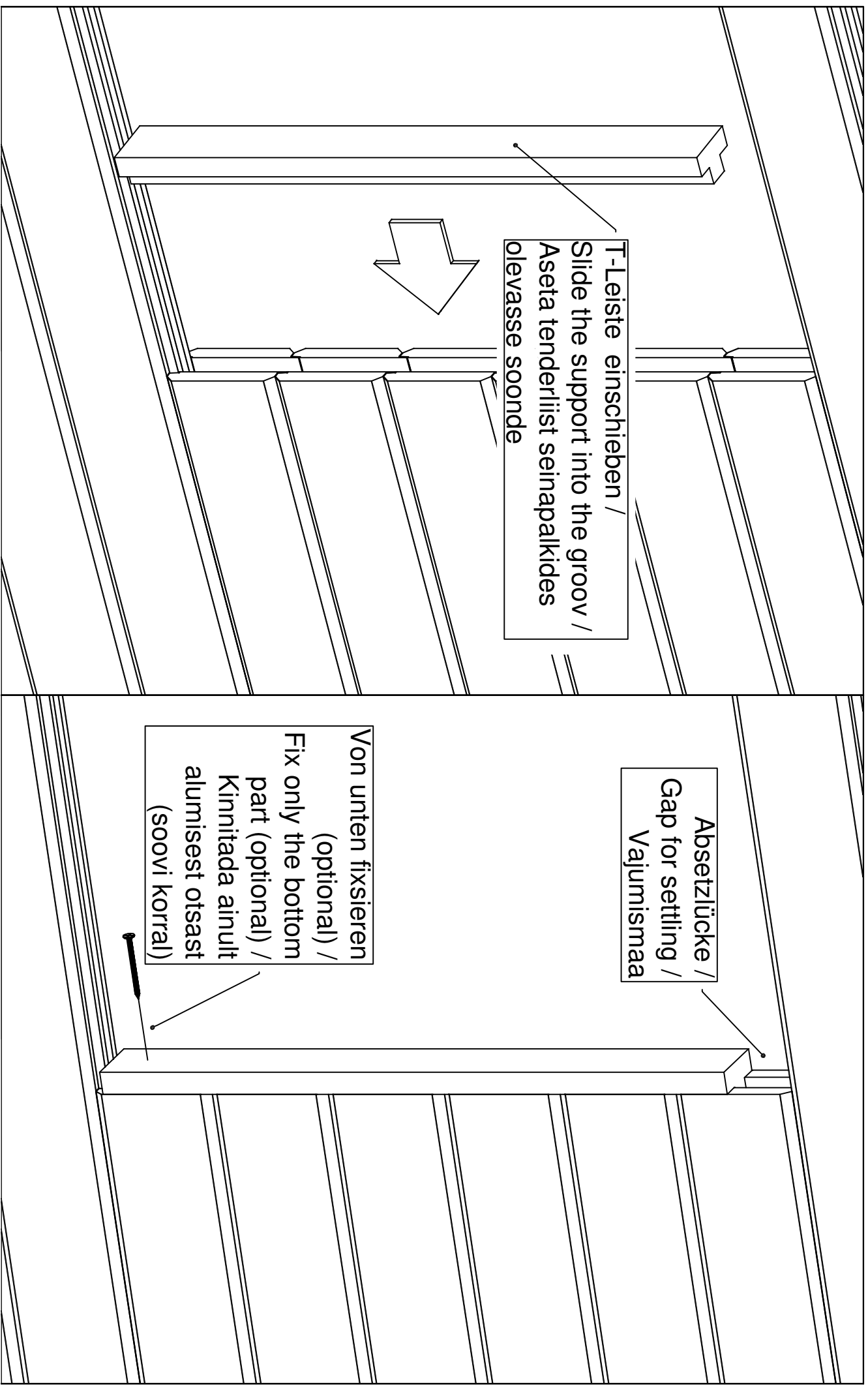

Aken	Q4-Q6	-	paigaldusjuhhis
Window	Q4-Q6	-	assembly instructions
Fenster	Q4-Q6	-	Montageanleitung

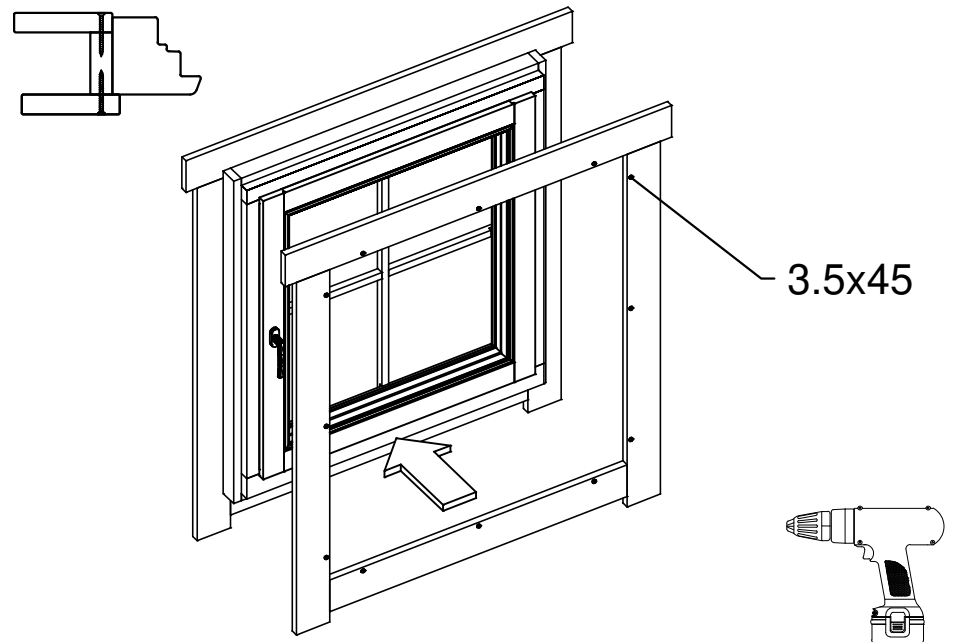
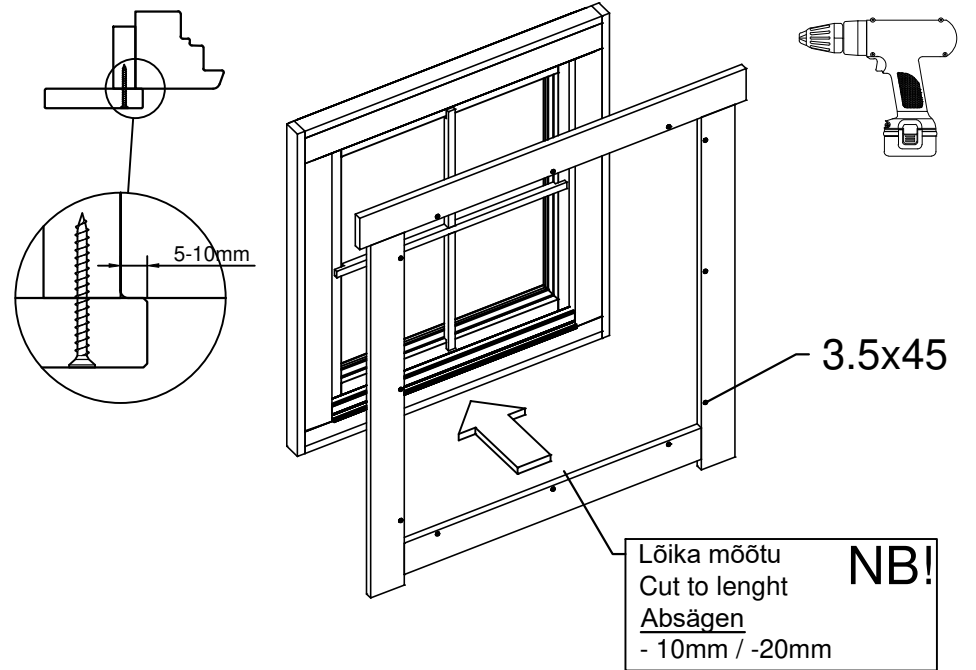
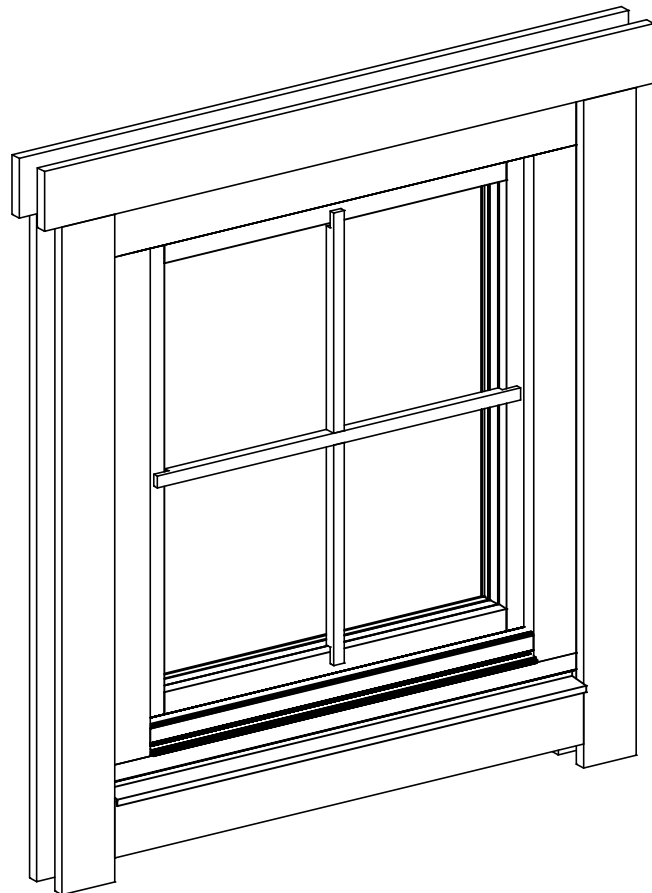

Vihmaliist / Rain strip / Wasserleiste

Q5-Q6

*Silikoon
*Silicon
*Silikon

*Vajumispiilu
*Settling gap
*Senkungs spalt

ca 40-50mm

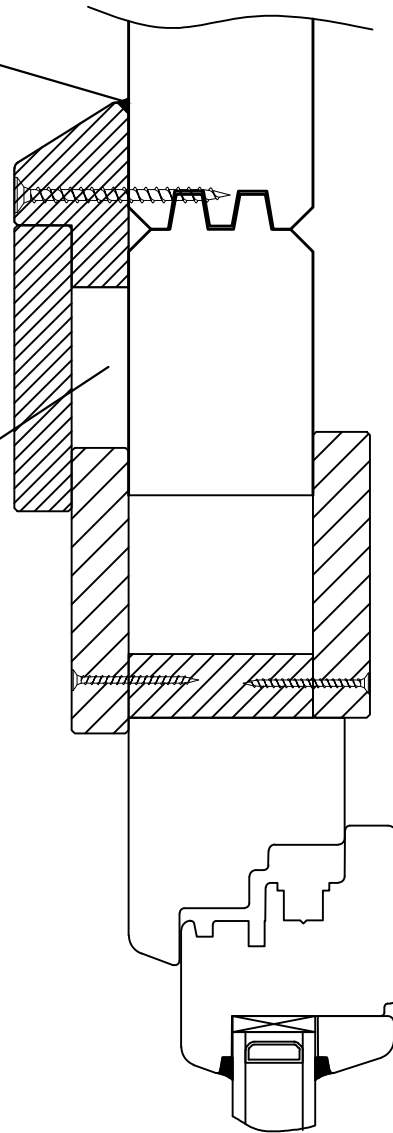
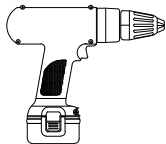

NB!

- Monteerida juhul kui ese on välja toodud maja spetsifikatsioonis!
- Install only if the item is listed in the house specification!
- Nur montieren wenn die Leiste in der Teilleiste gezeigt ist!

Veepilekk / Window sill / Fensterbank

4,2x16

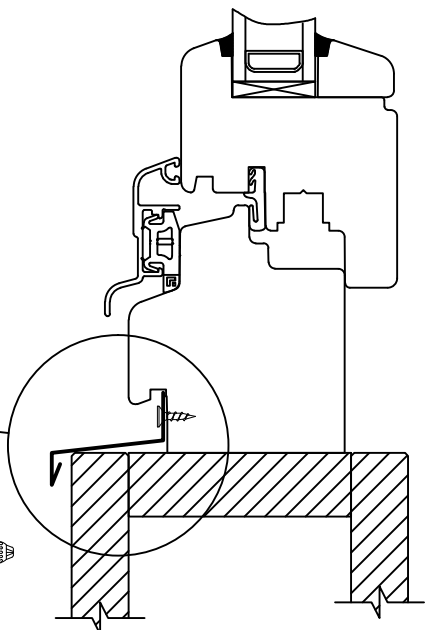
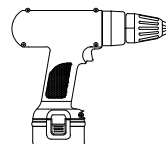
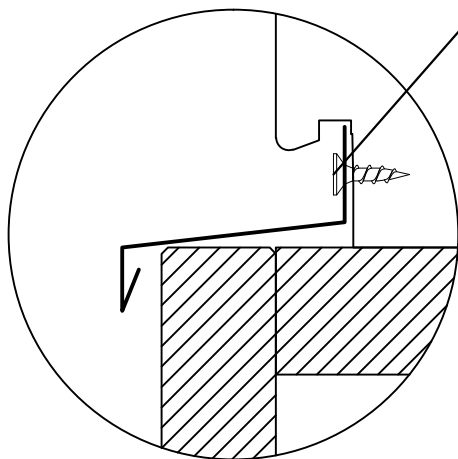

Ukse montaaž / Tür montage / Door assembly
(GH+ / SH)

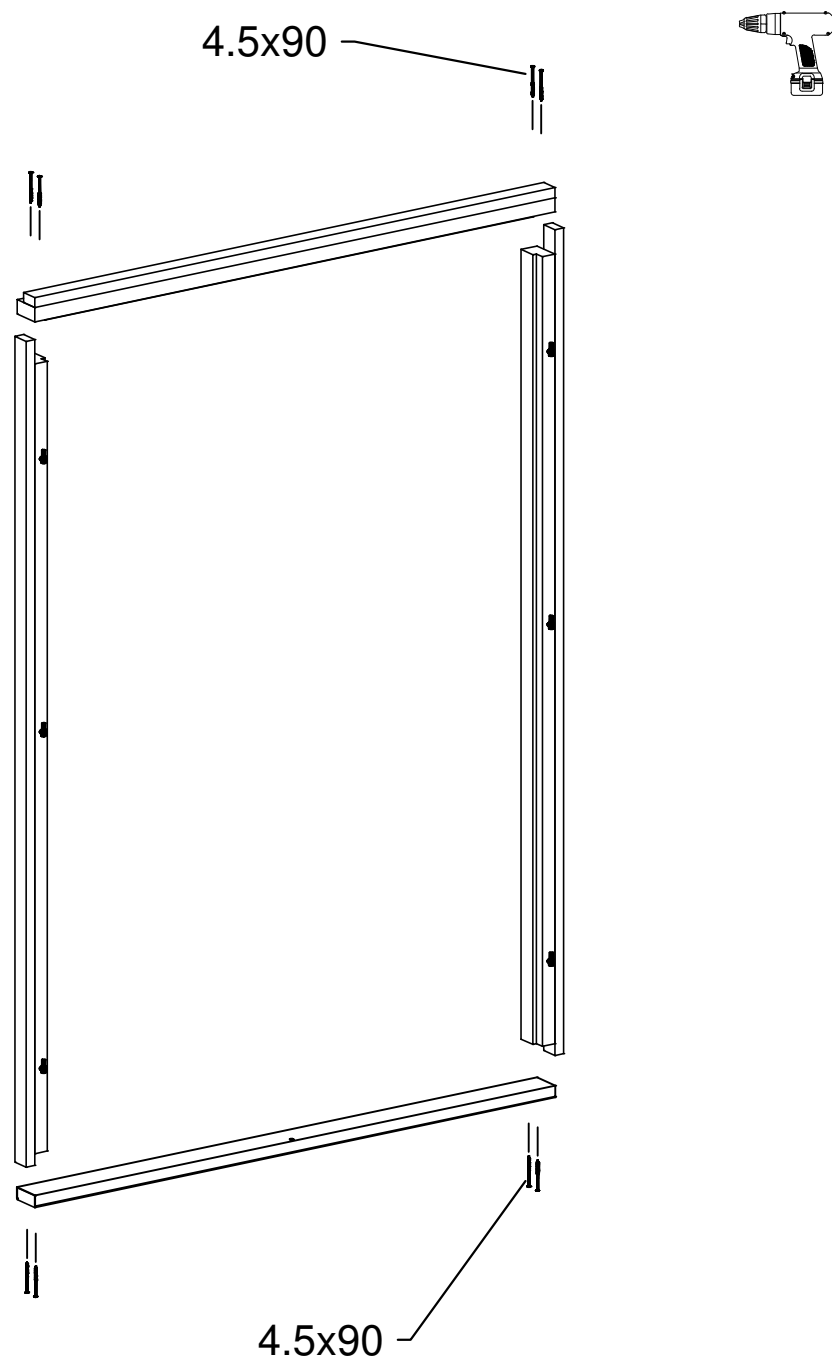
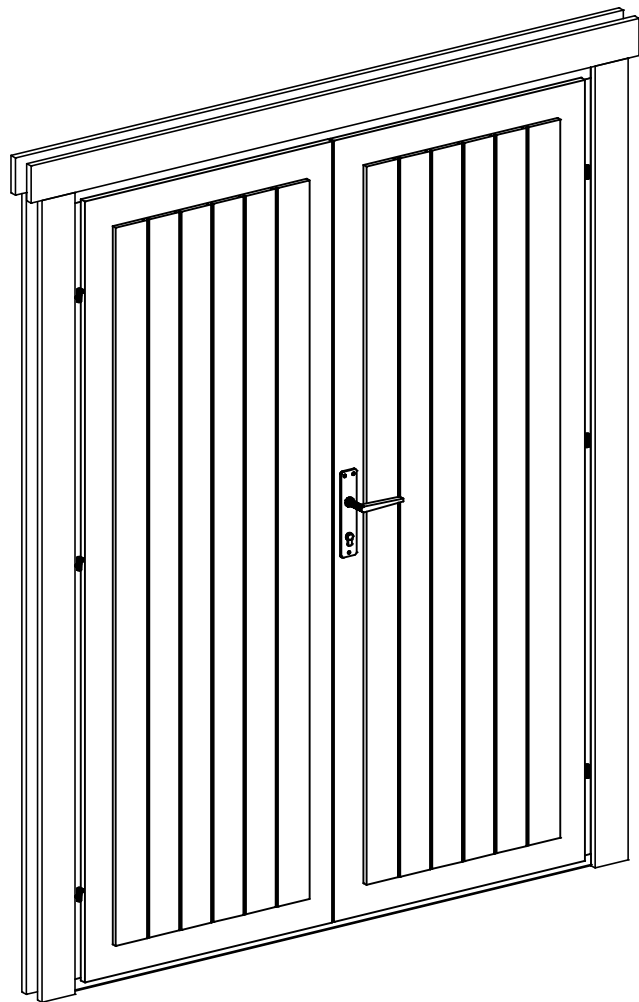

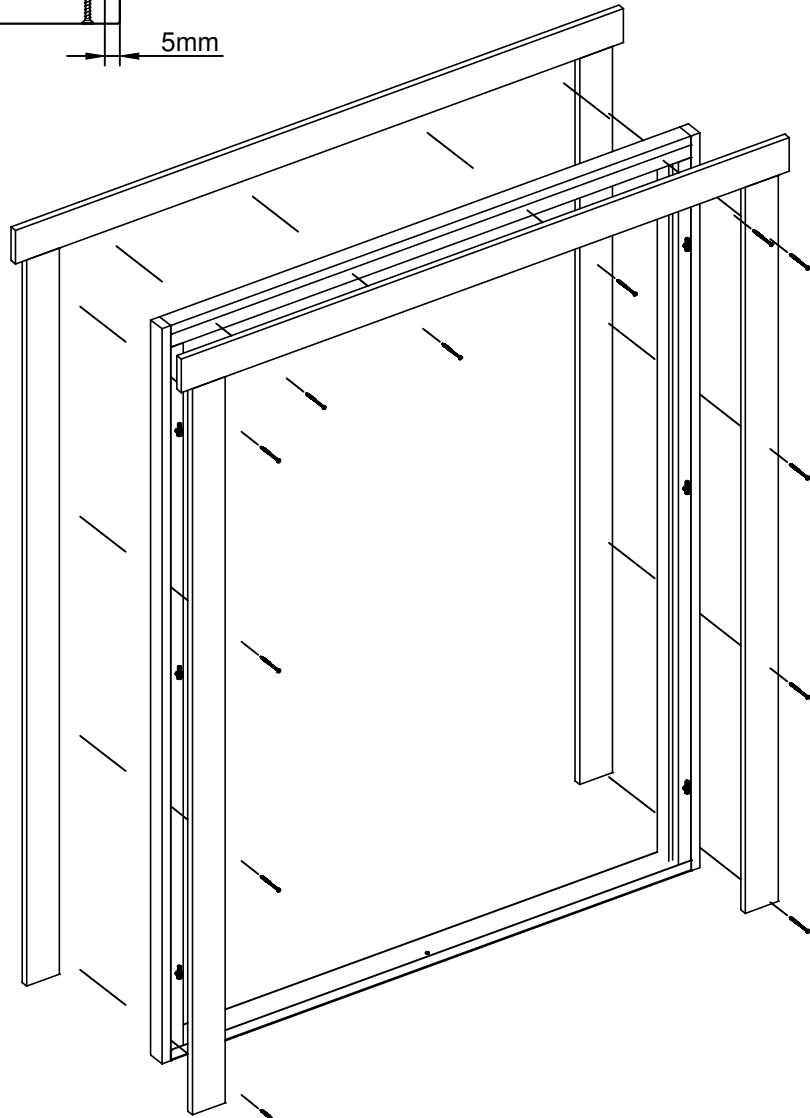
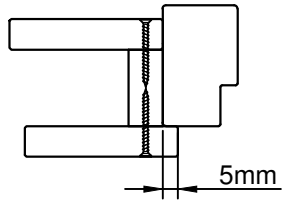

3.5x45

A label with a leader line pointing to the bottom rail of the window frame, indicating its dimensions as 3.5x45.



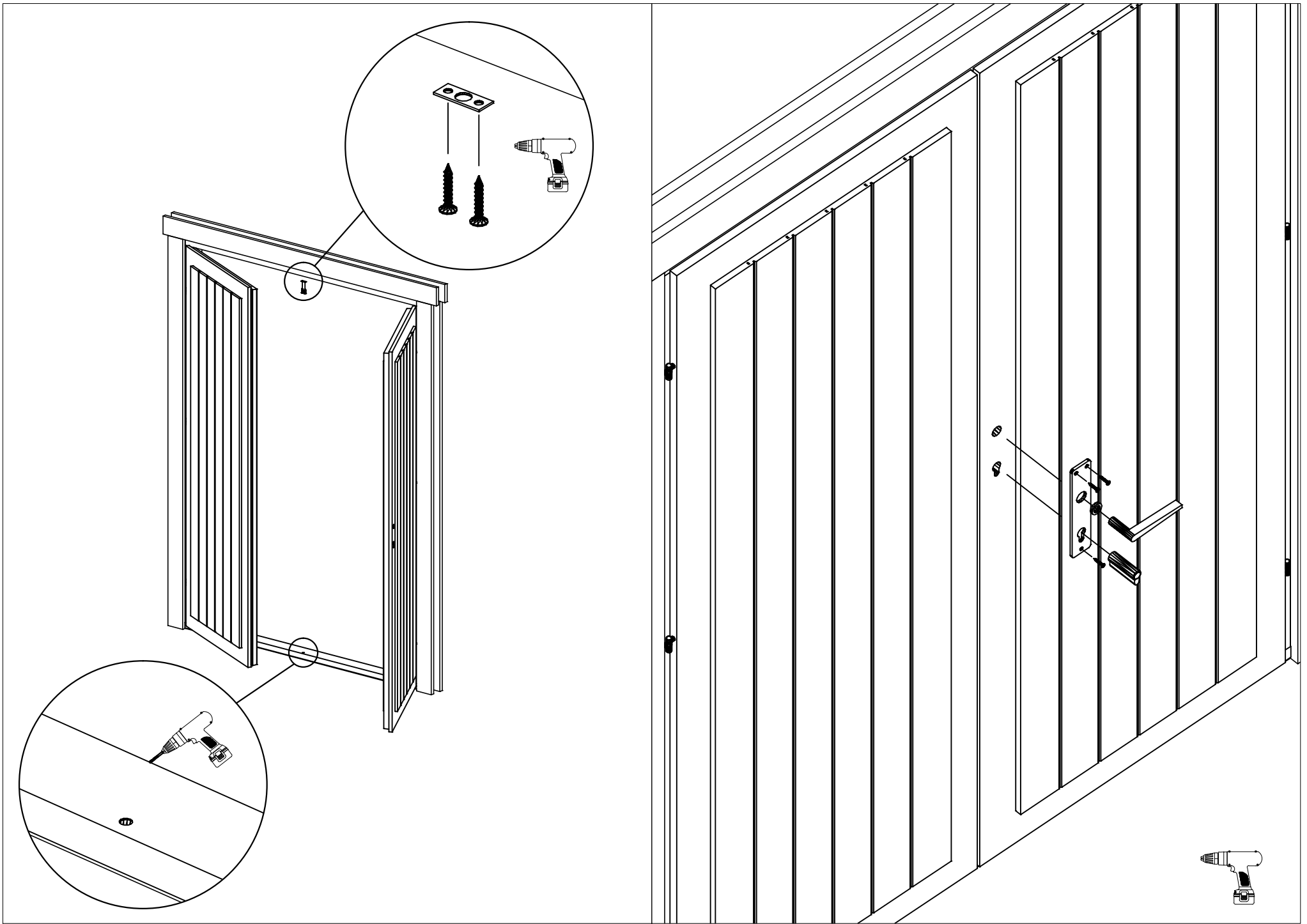

Vihmaliist / Head flashing / Regenschutz

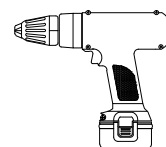
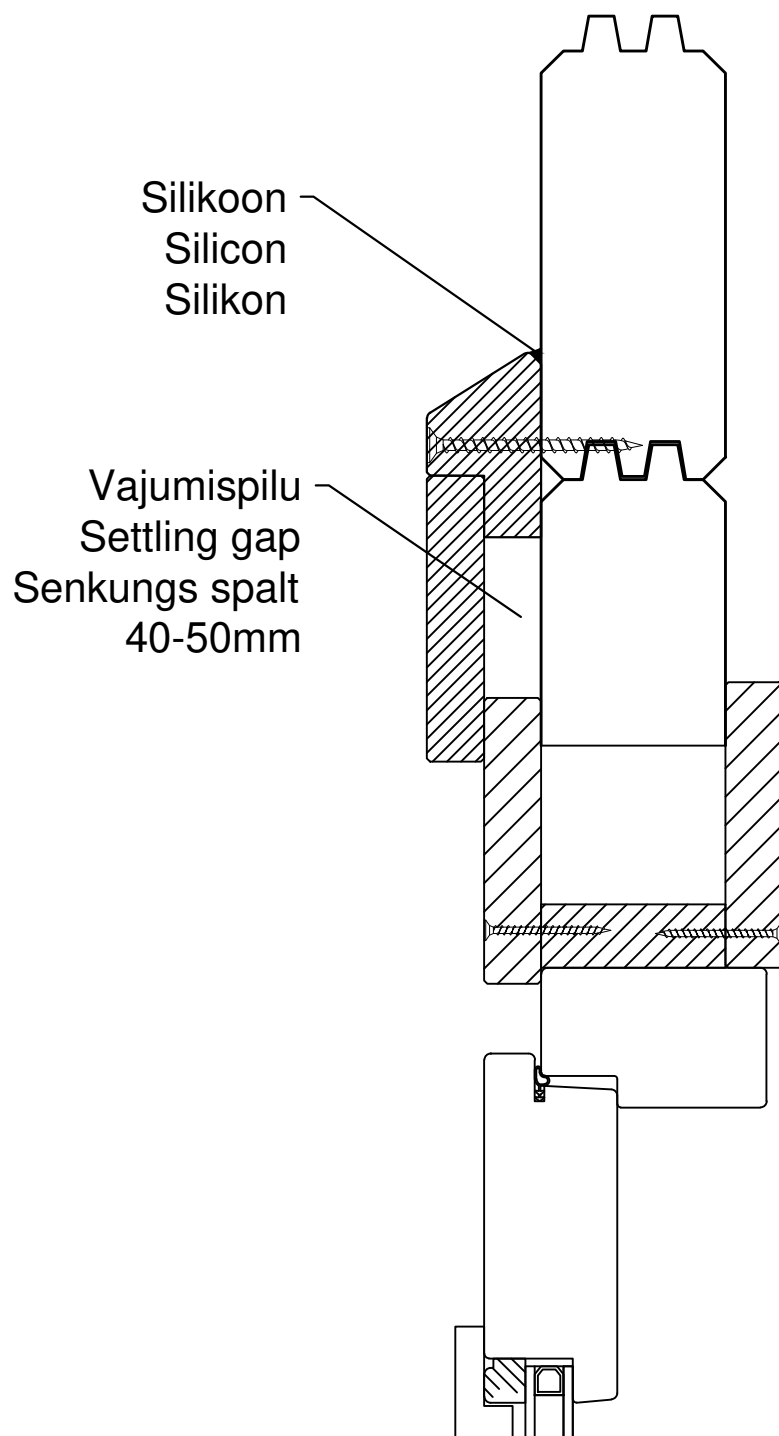

NB!

- Monteerida juhul kui ese on välja toodud maja spetsifikatsioonis!
- Install only if the item is listed in the house specification!
- Nur montieren wenn die Leiste in der Teilleiste gezeigt ist!