

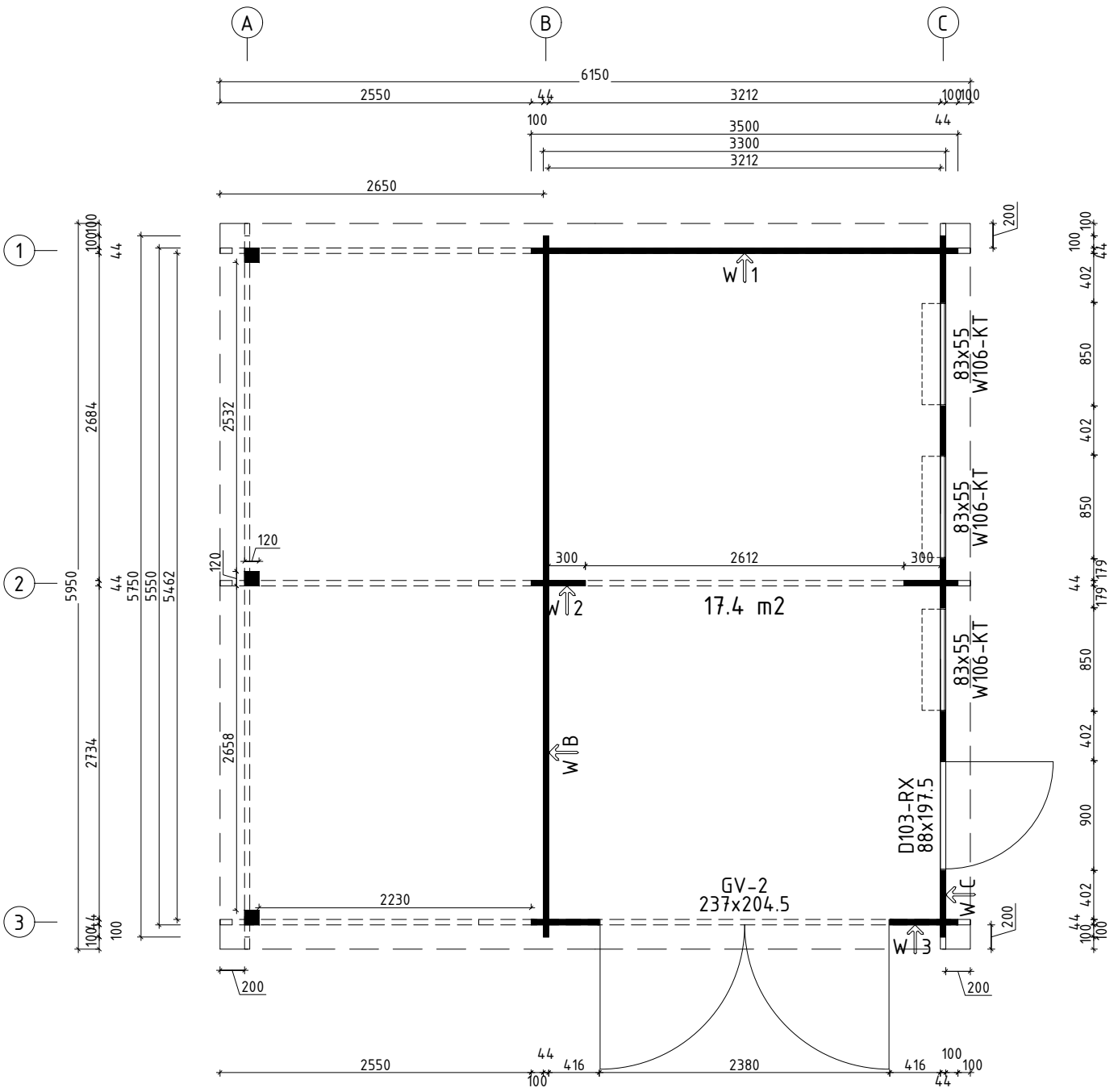



Name	Garage H 44 595x575 44	SKU	G0192
Drawing/Zeichnung	3D	Format	
Profile/Profil	4.4x13.5	Scale/Maßstab	Date
			11.03.2024





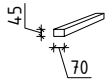
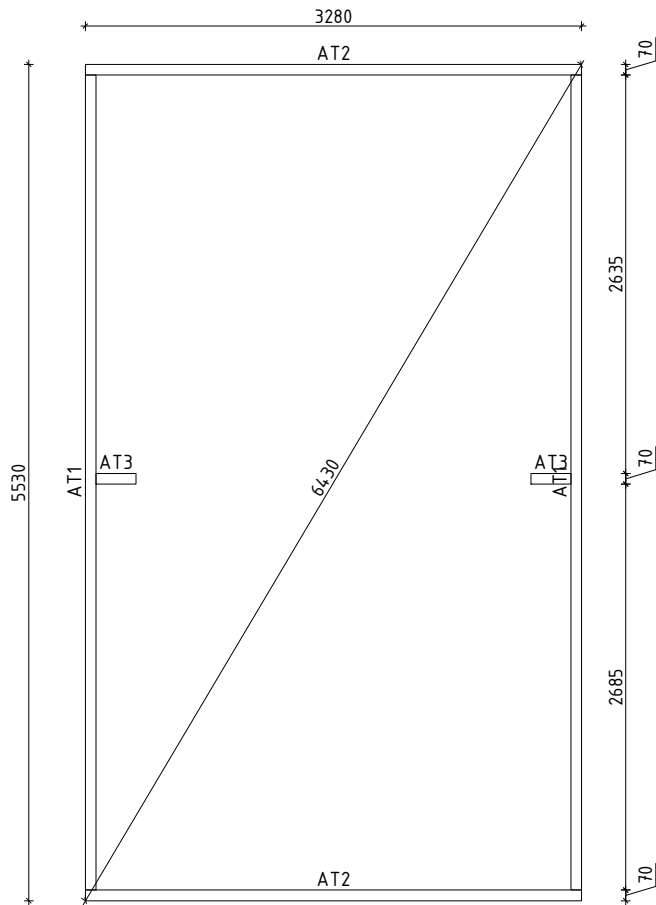



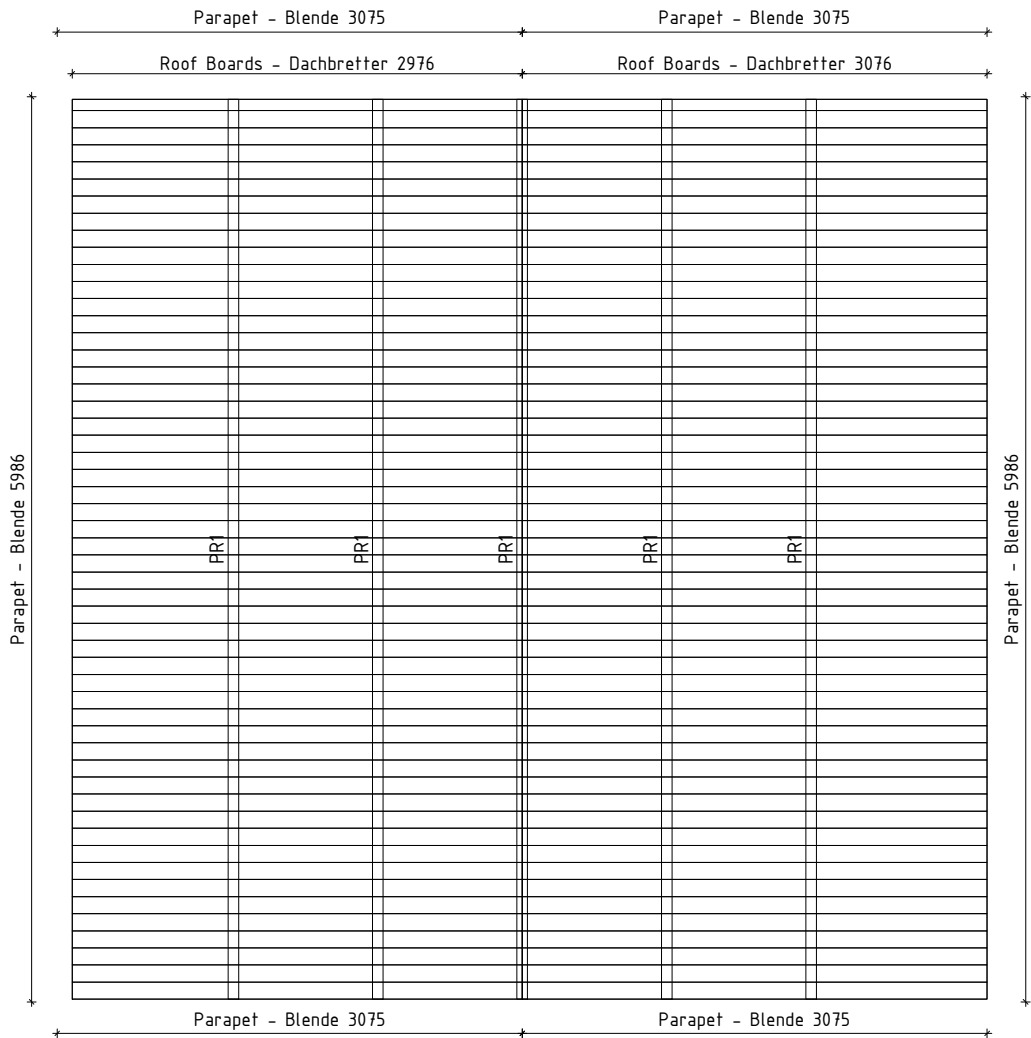



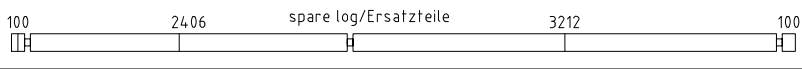
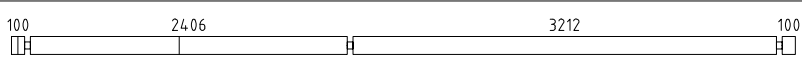
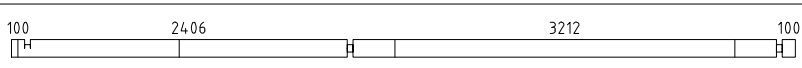
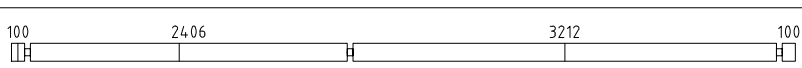
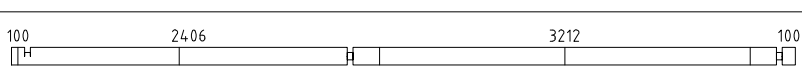

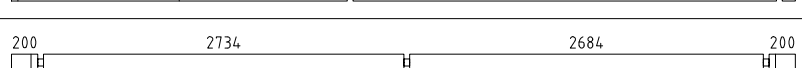

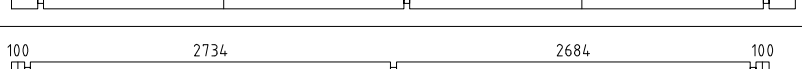

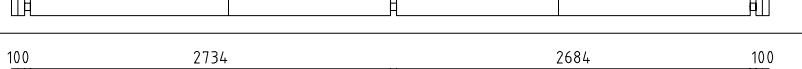
 www.hansa24.com	Name		Garage H 44 595x575 44		SKU		G0192				
	Drawing/Zeichnung		Plan_Grundplan				Format		A4		
	Profile/Profil		4.4x13.5		Scale/Maßstab		1:50		Date		11.03.2024

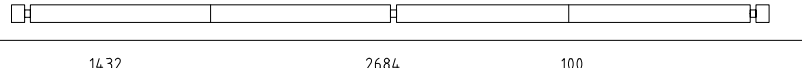

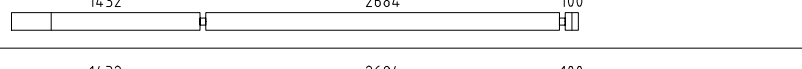
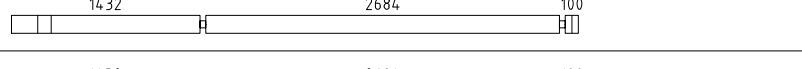
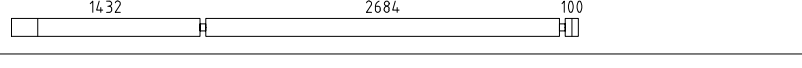
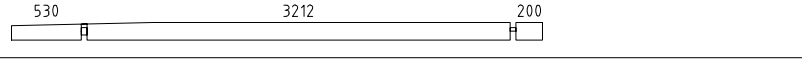
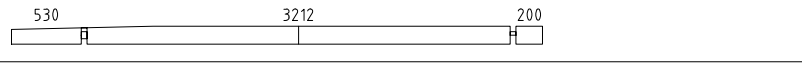

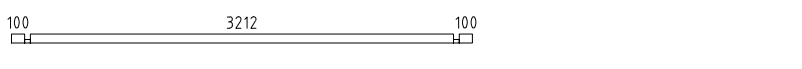
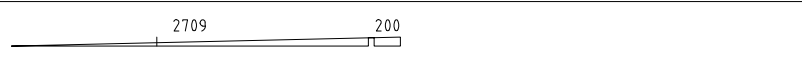
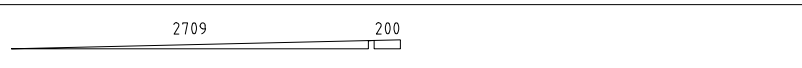





















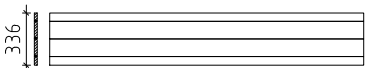
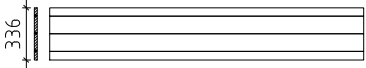
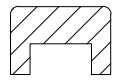
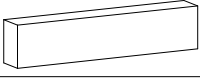

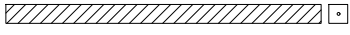
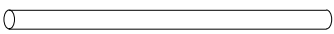

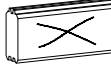

 www.hansa24.com	Name		Garage H 44 595x575 44		SKU	G0192
	Drawing/Zeichnung		Foundation plan_Lagerholzplan		Format	A4
	Profile/Profil	4.4x13.5	Scale/Maßstab	1:50	Date	11.03.2024

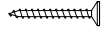
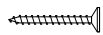
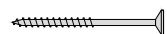
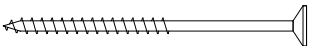
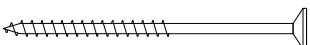
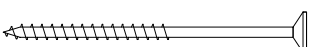
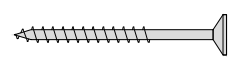
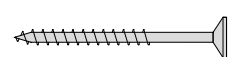



 <a href="http://www.hansa24.com">www.hansa24.com</a>	Name		Garage H 44 595x575 44		SKU	G0192
	Drawing/Zeichnung		Roof plan_Dachplan		Format	A4
	Profile/Profil	4.4x13.5	Scale/Maßstab	1:50	Date	11.03.2024



Pos	Model Garage H 44 595x575 44	Pcs	Profile (mm)	Length (mm)
	Notice! The gable pieces can be partly pre-assembled! Please notice - those differ from the description given in the specification list.			
	Achtung! Die Giebelbohlen können teilweise schon vormontiert sein! Bitte beachten - diese erscheinen nicht ganz so wie in der Teilleiste beschrieben.			
	<b>✓</b> - Cut into length on site (if needed)! / Bitte selber anpassen (falls nötig)!			
003		1	44x135	5950
001		2	44x135	5950
002		1	44x135	5950
003		1	44x135	5950
004		1	44x135	5950
005		1	44x135	5950
006		1	44x130	5950
007		1	44x135	5950
008		20	44x135	5750
009		1	44x135	5750
010		1	44x56	5750
011		1	44x135	5750
012		1	44x135	4304
013		7	44x135	4304
014		2	44x135	4304
015		1	44x135	4304
016		2	44x135	4030
017		1	44x135	4030
018		15	44x135	3500
019		1	44x68	3500
020		1	44x68	2953
021		2	44x68	2953
022		3	44x110	2120
023		12	44x135	560
024		4	44x135	560
025		14	44x135	560
Kood	Garage H 44 595x575 44	Materjal	File	G0192 Garage H 44 595x575 44.dwg

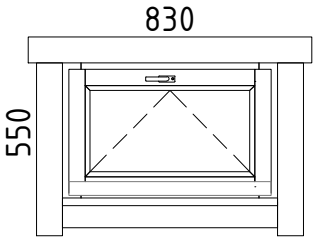

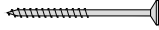
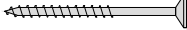

Pos	Model Garage H 44 595x575 44	Pcs	Profile (mm)	Length (mm)
026		2	44x68	560
027		19	44x135	546
028		12	44x135	444
029		4	44x135	444
030		14	44x135	444
031		2	44x68	444
032		8	44x135	402
033		4	44x135	402
AT1	FOUNDATION BEAMS (impregnated) - FUNDAMENTHÖLZER (imprägniert) 	2	70x45	5390
AT2	FOUNDATION BEAMS (impregnated) - FUNDAMENTHÖLZER (imprägniert) 	2	70x45	3280
AT3	FOUNDATION BEAMS (impregnated) - FUNDAMENTHÖLZER (imprägniert) 	2	70x45	264
PR1	PURLINS - PFETTEN 	5	70x145	5950
	ROOF BOARDS - DACHBRETTER 	53+2	113x18	3076
	ROOF BOARDS - DACHBRETTER 	53	113x18	2976
	Ceiling mouldings - Deckenleisten (inside and outside - innen und außen) ✓ 		15x28	66 rm/lfm
RLI01-1	Eave slat - Traufenleiste 18x40 ✓ 		18x40	14 rm/lfm
KAR1-1	Parapet - Blende 336 	4	18x336	3075
KAR1-2	Parapet - Blende 336 	2	18x336	5986
KAR2-1	Parapet cover - U-Profil für Blenden ✓ 		44x65	28 rm/lfm
KAR3-1	Parapet support - Blendestütze 44x65 	8	44x65	200
KAR4-1	Parapet- connecting slat - Blende- Verbindungsleiste 	2	18x120	330
TP120-1	Support post - Stützpfoste 120x120 v1 	3	120x120	2160
ÜV1	Metal bar - Metallstange Ø10 	10	Ø10	1170
ÜV2	Metal bar - Metallstange Ø10 	1	Ø10	770
Kood	Garage H 44 595x575 44	Materjal	File	G0192 Garage H 44 595x575 44/8wg

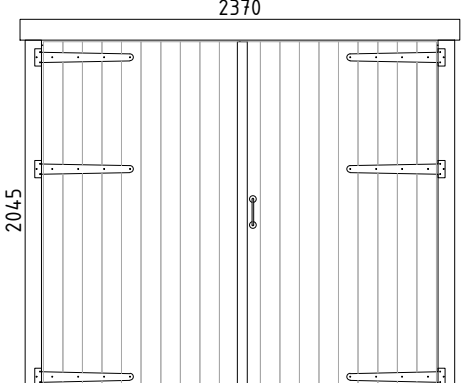
Pos	Model Garage H 44 595x575 44		Pcs	Profile (mm)	Length (mm)
PJ02	Adjustable post support - Verstellbare Pfostenstütze M20		3		
LK	Hit block - Schlaghölzer		3		
N-0 2501	Nails - Nägel vierkant 2.5x50 for ceiling boards - für Dachbretter		954		
KR-0 3001	Screws - Schrauben 3.0x30 for ceiling mouldings - für Deckenleisten		112		
KR-0 3002	Screws - Schrauben 3.0x30 for eave slats - für Traufenleisten		28		
KR-0 3004	Screws - Schrauben 3.0x30 for parapet connecting slat - für Verbindungsleiste des Blendes		16		
KR-0 3529	Screws - Schrauben 3.5x45 C3 for U-profile - für U-Profil		56		
KR-0 5080	Screws - Schrauben 5.0x100 for foundation beams - für Fundamenthölzer		24		
KR-0 5081	Screws - Schrauben 5.0x100 for parapet supports - für Blendestützen		16		
KR-0 5092	Screws - Schrauben 5.0x100 for support posts - für Stützpfeiler		6		
KR-0 5031	Screws - Schrauben 5.0x70 C3 for parapet fastening - für Blendenbefestigung		60		
KR-0 5033	Screws - Schrauben 5.0x70 C3 for post supports - für Pfostenstützen		24		
KL1	Threaded rod - Gewindestange M8		4		2000
KL2	Threaded rod - Gewindestange M8		2		590
KL3	Threaded rod - Gewindestange M8		2		516
KL4	Threaded rod - Gewindestange M8		1		503
KL5	Threaded rod - Gewindestange M8		6		410
KL6	Threaded rod - Gewindestange M8		2		300
	Nut - Mutter M8		13		
	Washer - Scheibe M8x24		13		
	Extended nut - Langmutter M8		4		
	Drive-in nut - Einschlagmutter M8		13		
Kood	Garage H 44 595x575 44	Materjal	File	G0192 Garage H 44 595x575 43/Bwg	

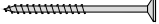
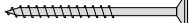
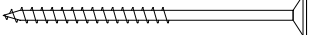
Pos	Model Garage H 44 595x575 44	Pcs	Profile (mm)	Length (mm)
	<p data-bbox="604 136 916 199">WINDOW 830x550 W5-S44K-0XT-08300550</p>  <p data-bbox="676 232 836 271"><u>W106-KT</u></p> <p data-bbox="651 313 1235 405">Tempered glass - Gehärtetes Glas Opens inside - Öffnet innen</p>	3		
VIHM 01-1	Rain deflector - Regenabweiser	 3	36x134	1030
KR-0 3524	Screws - Schrauben 3.5x45 C3 for door and window trims - für Tür- und Fensterleisten	 60		
KR-0 4001	Screws - Schrauben 4.0x60 C3 for rain deflector - für Regenabweiser	 9		
Kood	Garage H 44 595x575 44	Materjal	File	G0192 Garage H 44 595x575 44.dwg

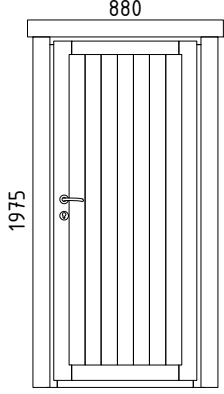

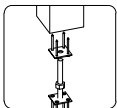
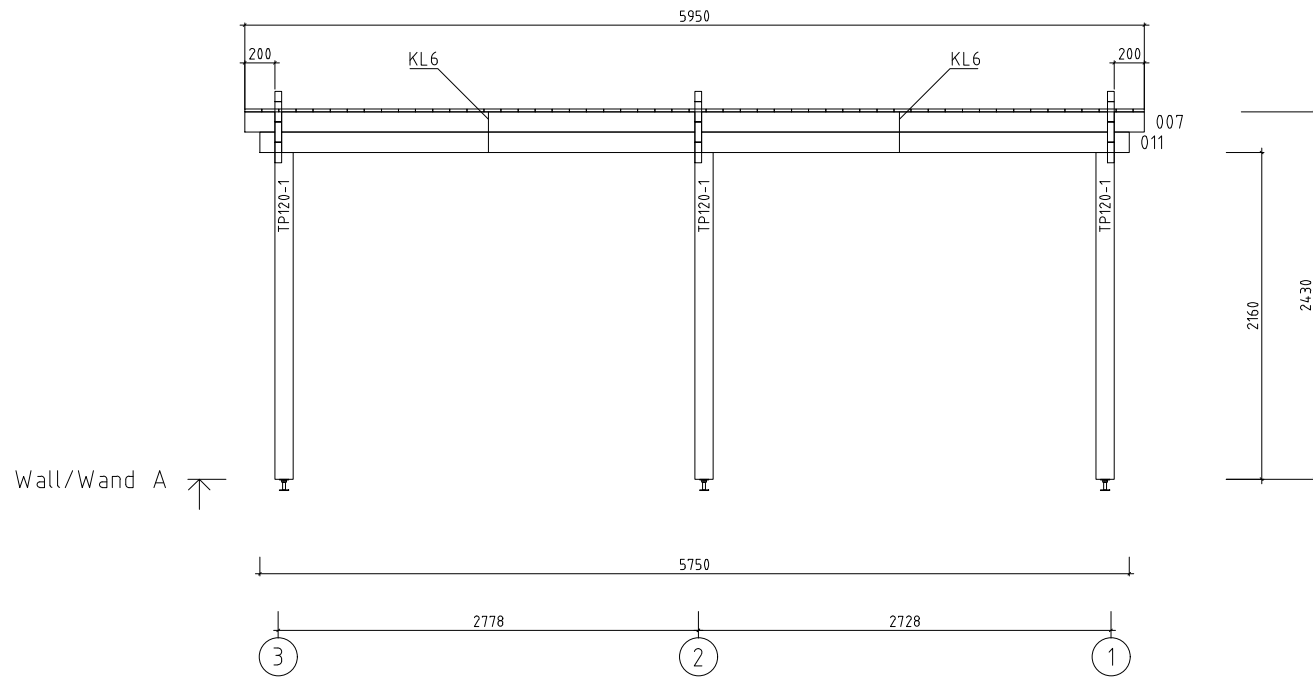

Pos	Model Garage H 44 595x575 44	Pcs	Profile (mm)	Length (mm)
	DOOR 2370x2045 D0-V44R-XXX-23702045  GV2 Right handed - DIN rechts Opens outside - Öffnet aussen	1		
VIHM 01-2	Rain deflector - Regenabweiser 	1	36x134	2570
PL11-1	Trims - Rahmenleisten for GV2 bottom if foundation beam removed (optional) 18x58 	2	18x58	1300
GV01	Lock set - Schloss-Kit	1		
KR-0 3524	Screws - Schrauben 3.5x45 C3 for door and window trims - für Tür- und Fensterleisten 	38		
KR-0 4001	Screws - Schrauben 4.0x60 C3 for rain deflector - für Regenabweiser 	5		
KR-0 5094	Screws - Schrauben 5.0x100 Door frame - Türrahmen 	8		
Kood	Garage H 44 595x575 44	Materjal	File	G0192 Garage H 44 595x575 44/6wg

Pos	Model Garage H 44 595x575 44	Pcs	Profile (mm)	Length (mm)	
	DOOR 880x1975 D5-S44R-XXX-08801975  D103-RX Right handed - DIN rechts Opens outside - Öffnet aussen	1			
VIHM 01-3	Rain deflector - Regenabweiser		1	36x134	1080
KR-0 3524	Screws - Schrauben 3.5x45 C3 for door and window trims - für Tür- und Fensterleisten		26		
KR-0 4001	Screws - Schrauben 4.0x60 C3 for rain deflector - für Regenabweiser		3		
Kood	Garage H 44 595x575 44	Materjal	File	G0192 Garage H 44 595x575 44	4/6wg

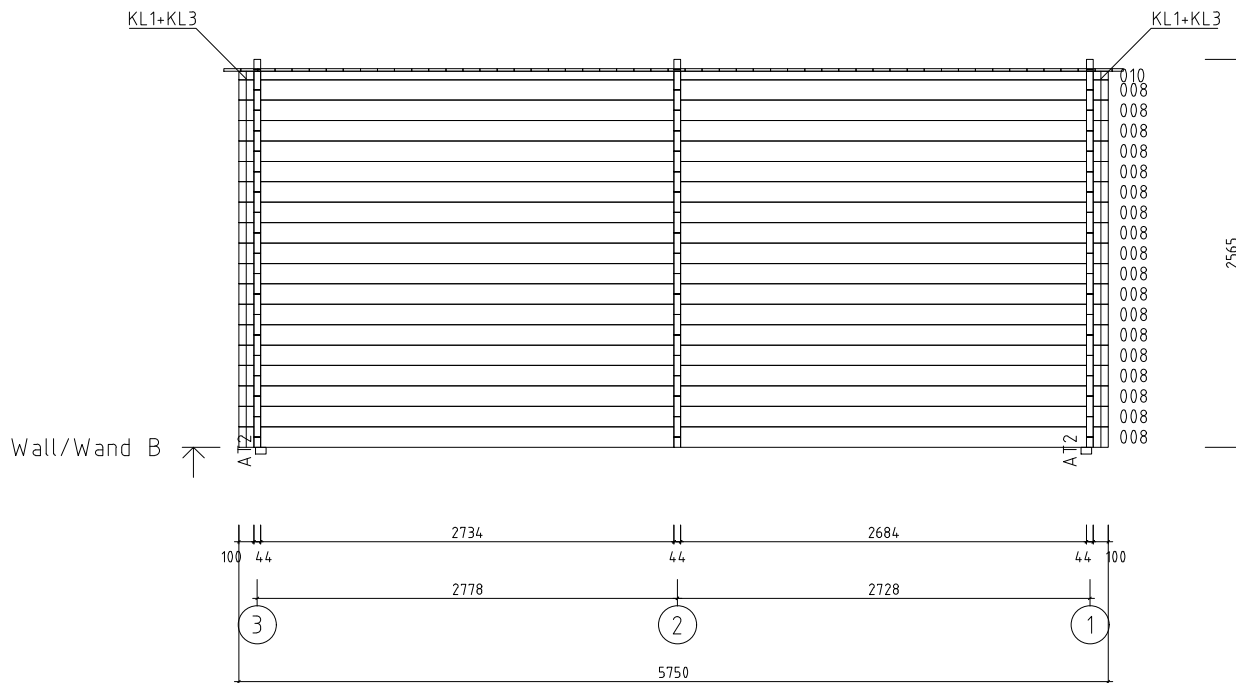

 <a href="http://www.hansa24.com">www.hansa24.com</a>	Name		Garage H 44 595x575 44		SKU		G0192	
	Drawing/Zeichnung		Wall/Wand A			Format		A4
	Profile/Profil		4.4x13.5	Scale/Maßstab		1:50	Date	



 <a href="http://www.hansa24.com">www.hansa24.com</a>	Name		Garage H 44 595x575 44		SKU		G0192				
	Drawing/Zeichnung		Wall/Wand B				Format		A4		
	Profile/Profil		4.4x13.5		Scale/Maßstab		1:50		Date		11.03.2024

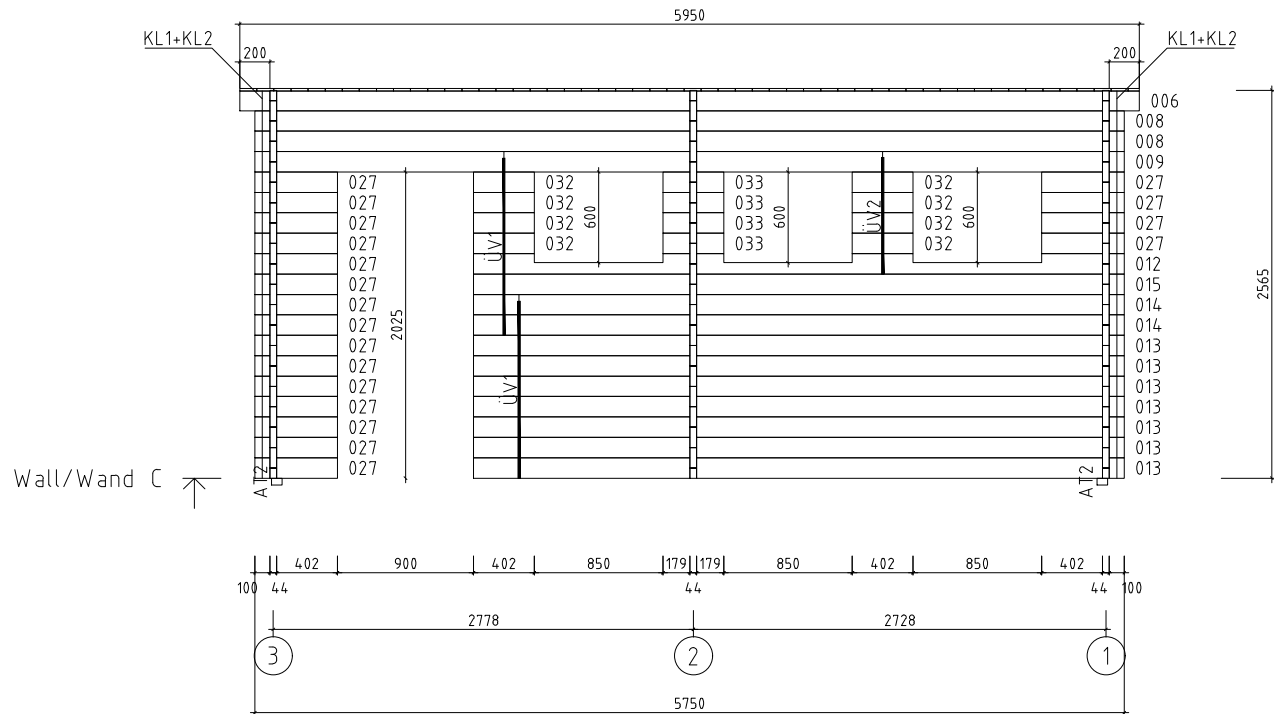

 <a href="http://www.hansa24.com">www.hansa24.com</a>	Name		Garage H 44 595x575 44		SKU		G0192	
	Drawing/Zeichnung		Wall/Wand C			Format		A4
	Profile/Profil		4.4x13.5	Scale/Maßstab		1:50	Date	

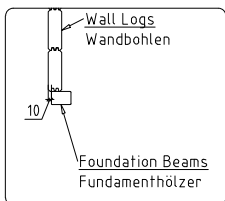
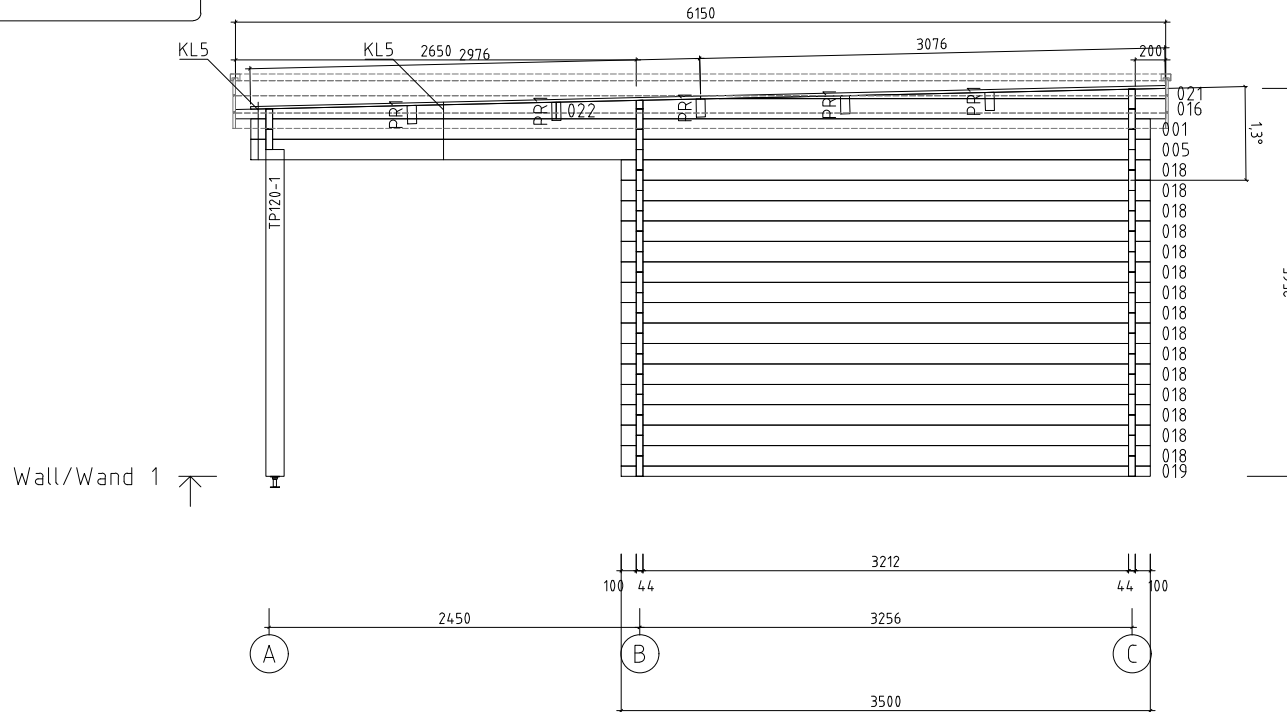
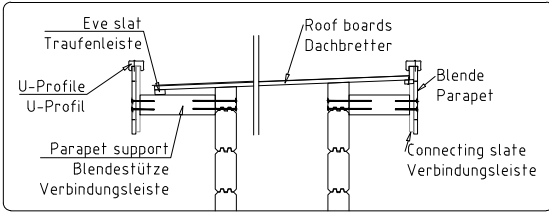

 <a href="http://www.hansa24.com">www.hansa24.com</a>	Name		Garage H 44 595x575 44	SKU		G0192
	Drawing/Zeichnung		Wall/Wand 1	Format		A4
	Profile/Profil	4.4x13.5	Scale/Maßstab	1:50	Date	11.03.2024

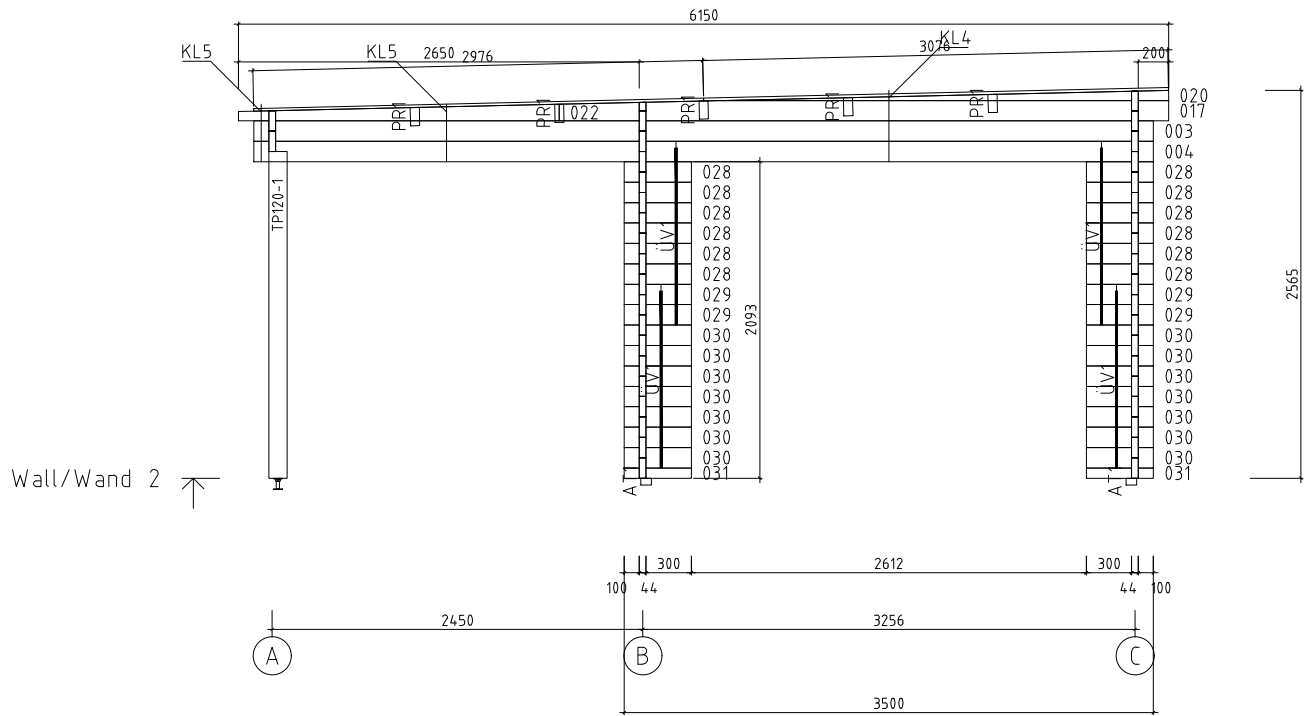

Name	Garage H 44 595x575 44		SKU	G0192	
Drawing/Zeichnung	Wall/Wand 2		Format	A4	
Profile/Profil	4.4x13.5	Scale/Maßstab	1:50	Date	11.03.2024

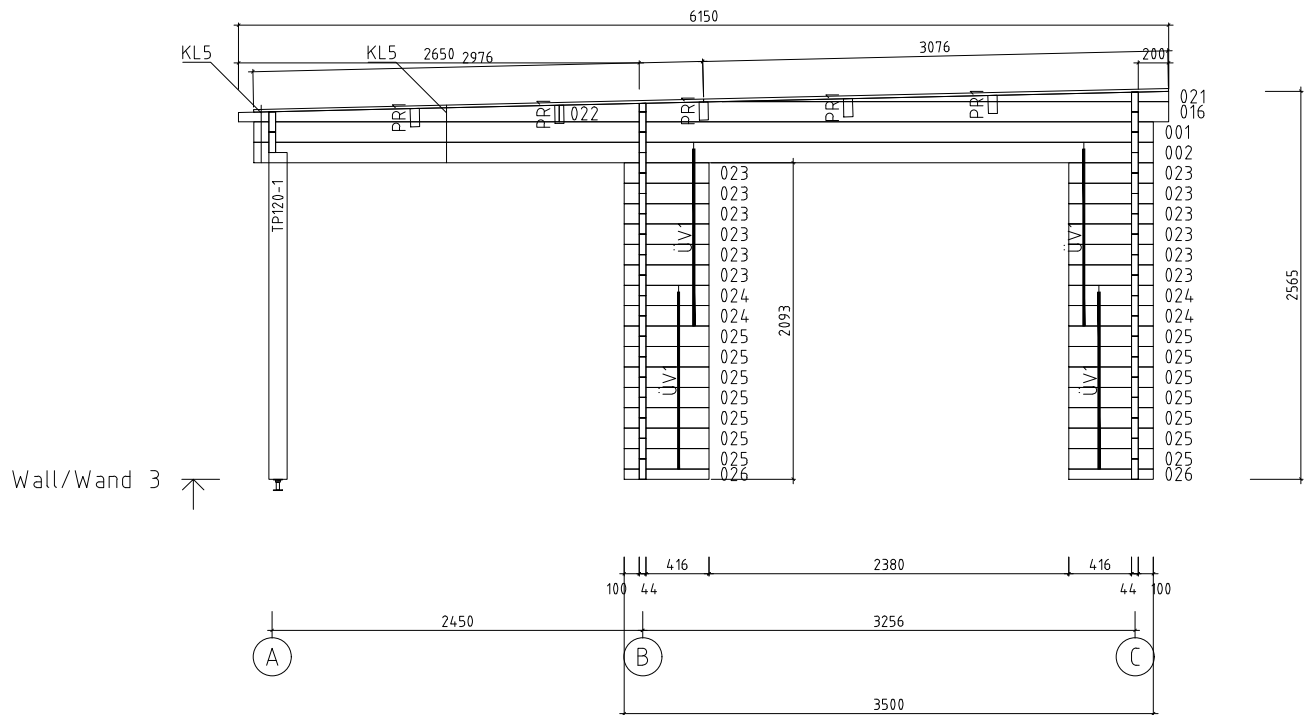

 <a href="http://www.hansa24.com">www.hansa24.com</a>	Name		Garage H 44 595x575 44		SKU		G0192
	Drawing/Zeichnung		Wall/Wand 3		Format		A4
	Profile/Profil	4.4x13.5	Scale/Maßstab	1:50	Date	11.03.2024	