

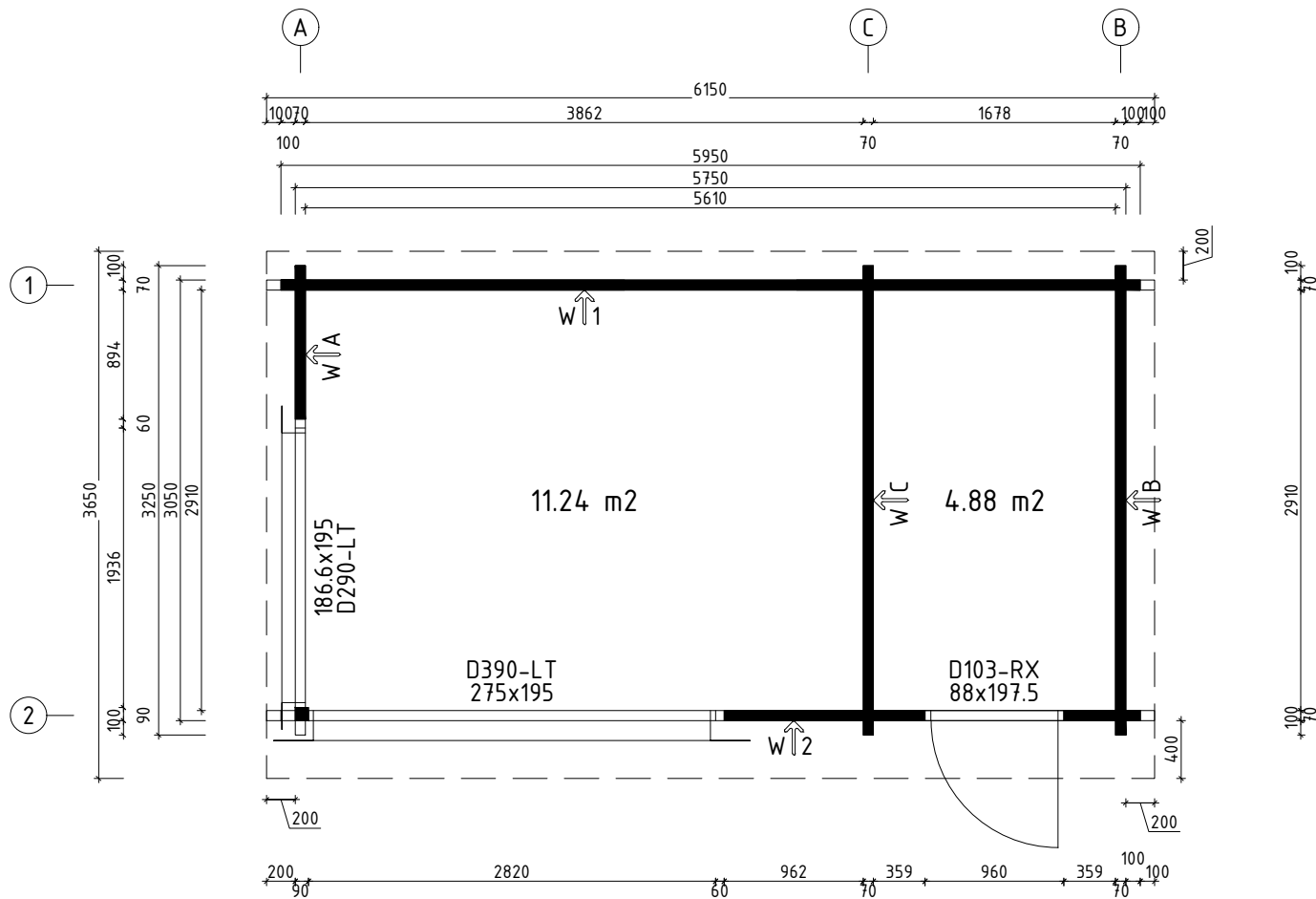

 www.hansa24.com	Name	Aaron 595x325 70	SKU	G0392
	Drawing/Zeichnung	3D		Format
	Profile/Profil	7.0x13.5	Scale/Maßstab	Date



 www.hansa24.com	Name		Aaron 595x325 70		SKU		G0392
	Drawing/Zeichnung		Plan_Grundplan		Format		A4
	Profile/Profil	7.0x13.5	Scale/Maßstab	1:50	Date	22.05.2024	



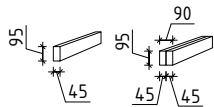
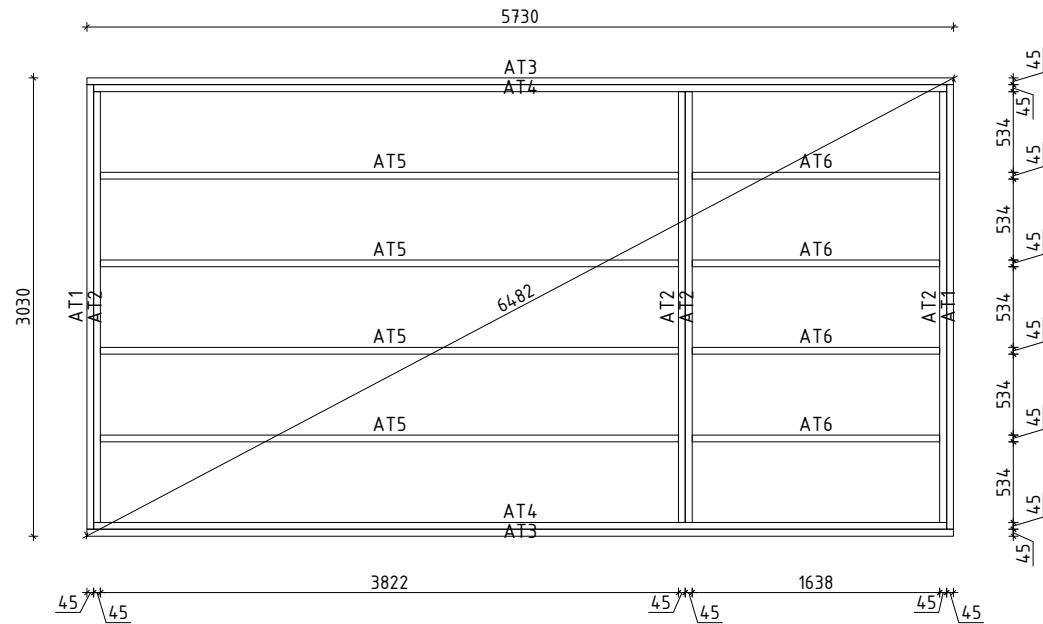

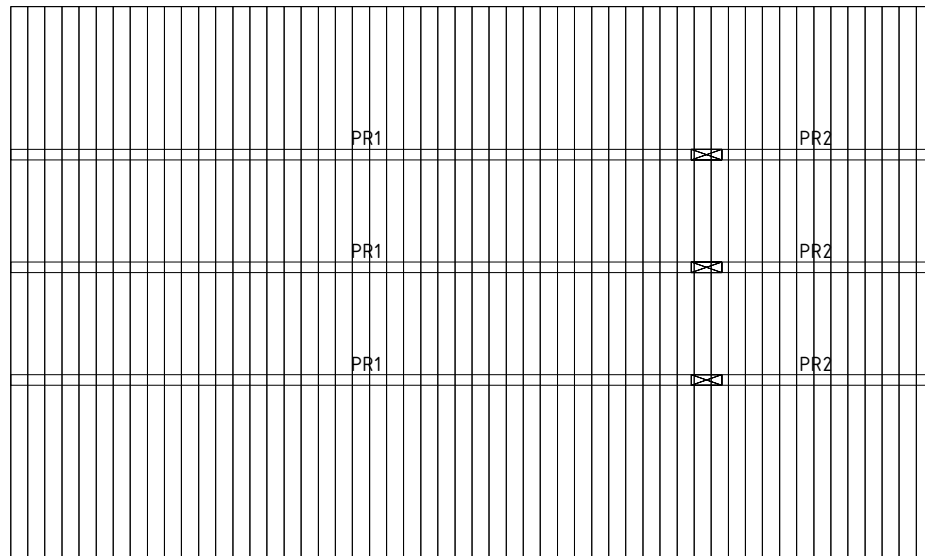





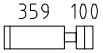

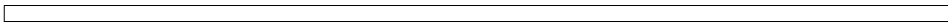
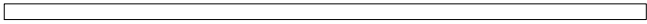





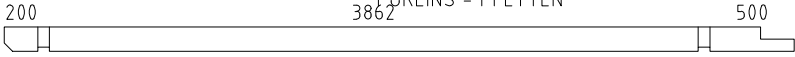
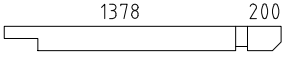
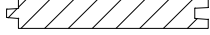







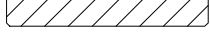



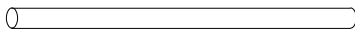
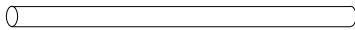
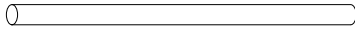

 www.hansa24.com	Name		Aaron 595x325 70		SKU	G0392
	Drawing/Zeichnung		Foundation plan_Lagerholzplanoundat		Format	A4
	Profile/Profil	7.0x13.5	Scale/Maßstab	1:50	Date	22.05.2024

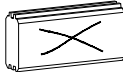

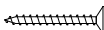
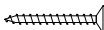
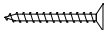

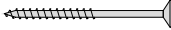
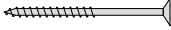
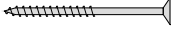
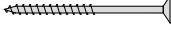
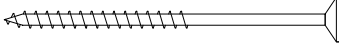
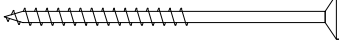
 www.hansa24.com	Name		Aaron 595x325 70		SKU	G0392
	Drawing/Zeichnung		Roof plan_Dachplan		Format	A4
	Profile/Profil	7.0x13.5	Scale/Maßstab	1:50	Date	22.05.2024

Pos	Model Aaron 595x325 70	Pcs	Profile (mm)	Length (mm)
	Notice! The gable pieces can be partly pre-assembled! Please notice - those differ from the description given in the specification list.			
	Achtung! Die Giebelbohlen können teilweise schon vormontiert sein! Bitte beachten - diese erscheinen nicht ganz so wie in der Teilleiste beschrieben.			
	✓ - Cut into length on site (if needed)! / Bitte selber anpassen (falls nötig)!			
001		1	70x135	5950
001		1	70x135	5950
002		1	70x135	5950
003		14	70x135	5950
004		2	70x135	5950
005		1	70x135	4167
006		1	70x61	4167
007		1	70x135	4167
008		2	70x135	3250
009		1	70x135	3250
010		32	70x135	3250
011		2	70x68	3250
012		1	70x135	3250
013		1	70x135	3250
014		2	70x135	2053
015		1	70x135	2053
016		1	70x135	1983
017		1	70x61	1983
018		1	70x135	1983
019		6	70x135	1451
020		2	70x135	1451
021		7	70x135	1451
022		5	70x135	1124
023		2	70x135	1124
024		7	70x135	1124
025		1	70x68	1124
Kood	Aaron 595x325 70	Materjal	File	Leht 1/7

Pos	Model Aaron 595x325 70	Pcs	Profile (mm)	Length (mm)
026		15	70x135	529
AT3	FOUNDATION BEAMS (impregnated) - FUNDAMENTHÖLZER (imprägniert) 	2	45x95	5730
AT4	FOUNDATION BEAMS (impregnated) - FUNDAMENTHÖLZER (imprägniert) 	2	45x95	5640
AT5	FOUNDATION BEAMS (impregnated) - FUNDAMENTHÖLZER (imprägniert) 	4	45x95	3822
AT1	FOUNDATION BEAMS (impregnated) - FUNDAMENTHÖLZER (imprägniert) 	2	45x95	2940
AT2	FOUNDATION BEAMS (impregnated) - FUNDAMENTHÖLZER (imprägniert) 	4	45x95	2850
AT6	FOUNDATION BEAMS (impregnated) - FUNDAMENTHÖLZER (imprägniert) 	4	45x95	1638
LI2	SLAT - LEISTE 	✓	145x18	2491
LI1	SLAT - LEISTE 	✓	120x18	2491
PR1	PURLINS - PFETTEN 	3	70x145	4702
PR2	PURLINS - PFETTEN 	3	70x145	1648
	ROOF BOARDS - DACHBRETTER 	55+1	113x18	3658
	FLOOR BOARDS - FUSSBODENBRETTER 	50+1	113x28	2905
	Ceiling mouldings - Deckenleisten (inside and outside - innen und außen) ✓ 		15x28	43 rm/lfm
	Floor mouldings - Fussbodenleisten ✓ 		14x55	24 rm/lfm
RLA 02-1	Eave board - Traufenbrett 18x120 	2	18x120	3093
RLA 01-1	Eave board - Traufenbrett 18x95 	2	18x95	3075
RKL 01-1	Eave cover slat - Traufendeckleiste 18x40 ✓ 	2	18x40	3125
RLI01-1	Eave slat - Traufenleiste 18x40 ✓ 		18x40	13.3 rm/lfm
VLA 02-1	Gable board - Giebelbrett 18x120 	2	18x120	3676
VKL 01-1	Gable cover slat - Giebeldeckleiste 18x40 ✓ 	2	18x40	3758
TP90-1	Support post - Stützpfoste 90x90 v0 	1	90x90	2010
	T-strip - T-Leiste 70 	2		1965
Kood	Aaron 595x325 70	Materjal	File	Leht 2/7

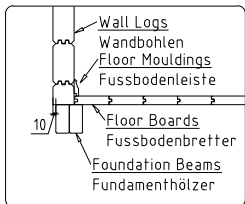
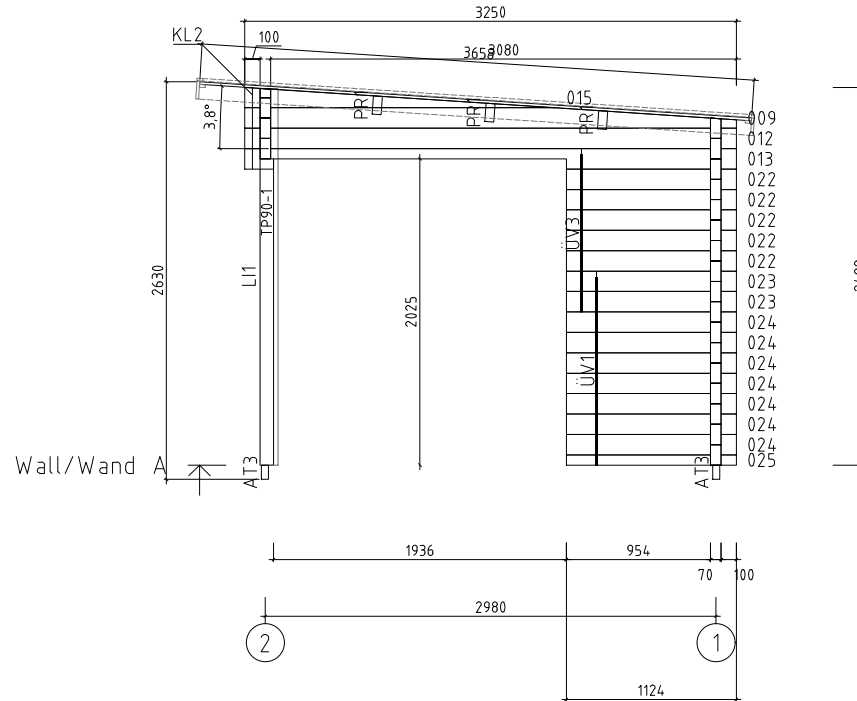
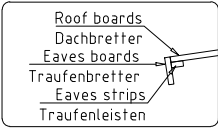
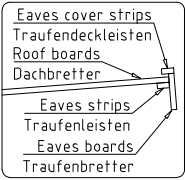
Pos	Model Aaron 595x325 70		Pcs	Profile (mm)	Length (mm)
ÜV1	Metal bar - Metallstange Ø10		1	Ø10	1240
ÜV2	Metal bar - Metallstange Ø10		2	Ø10	1170
ÜV3	Metal bar - Metallstange Ø10		1	Ø10	1040
ÜV4	Metal bar - Metallstange Ø10		2	Ø10	360
ÜV5	Metal bar - Metallstange Ø10		2	Ø10	290
ML01	Connecting strip for wall logs - Verbindungsstreifen für Wandbalken		3		
LK	Hit block - Schlaghölzer		3		
N-0 2503	Nails - Nägel 2.5x60 for floor boards - für Fussbodenbretter		600		
N-0 2501	Nails - Nägel vierkant 2.5x50 for ceiling boards - für Dachbretter		550		
KR-0 3001	Screws - Schrauben 3.0x30 for ceiling mouldings - für Deckenleisten		92		
KR-0 3002	Screws - Schrauben 3.0x30 for eave slats - für Traufenleisten		28		
KR-0 3003	Screws - Schrauben 3.0x30 for floor mouldings - für Fussbodenleisten		48		
KR-0 3522	Screws - Schrauben 3.5x45 C3 for connecting strip for wall logs - für Verbindungsstreifen für Wandbalken		12		
KR-0 3525	Screws - Schrauben 3.5x45 C3 for eave boards - für Traufenbretter		28		
KR-0 3526	Screws - Schrauben 3.5x45 C3 for eave cover slats - für Traufendeckleisten		14		
KR-0 3527	Screws - Schrauben 3.5x45 C3 for gable boards - für Giebelbretter		16		
KR-0 3521	Screws - Schrauben 3.5x45 C3 for gable cover slats - für Giebeldeckleisten		16		
KR-0 5080	Screws - Schrauben 5.0x100 for foundation beams - für Fundamenthölzer		72		
KR-0 5092	Screws - Schrauben 5.0x100 for support posts - für Stützpfeiler		4		
KL1	Threaded rod - Gewindestange M8		3		2000
KL2	Threaded rod - Gewindestange M8		1		570
KL3	Threaded rod - Gewindestange M8		1		521
KL4	Threaded rod - Gewindestange M8		2		325
Kood	Aaron 595x325 70		Materjal	File	Leht 3/7



 www.hansa24.com	Name		Aaron 595x325 70		SKU	G0392
	Drawing/Zeichnung		Wall/Wand A		Format	A4
	Profile/Profil	7x13.5	Scale/Maßstab	1:50	Date	22.05.2024

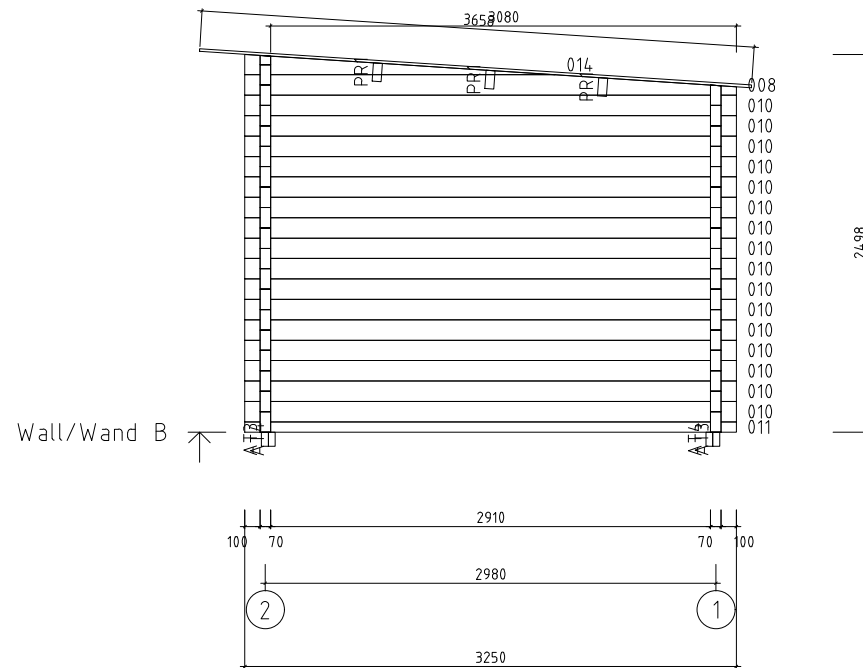

 www.hansa24.com	Name		Aaron 595x325 70		SKU	G0392
	Drawing/Zeichnung		Wall/Wand B		Format	A4
	Profile/Profil	7x13.5	Scale/Maßstab	1:50	Date	22.05.2024

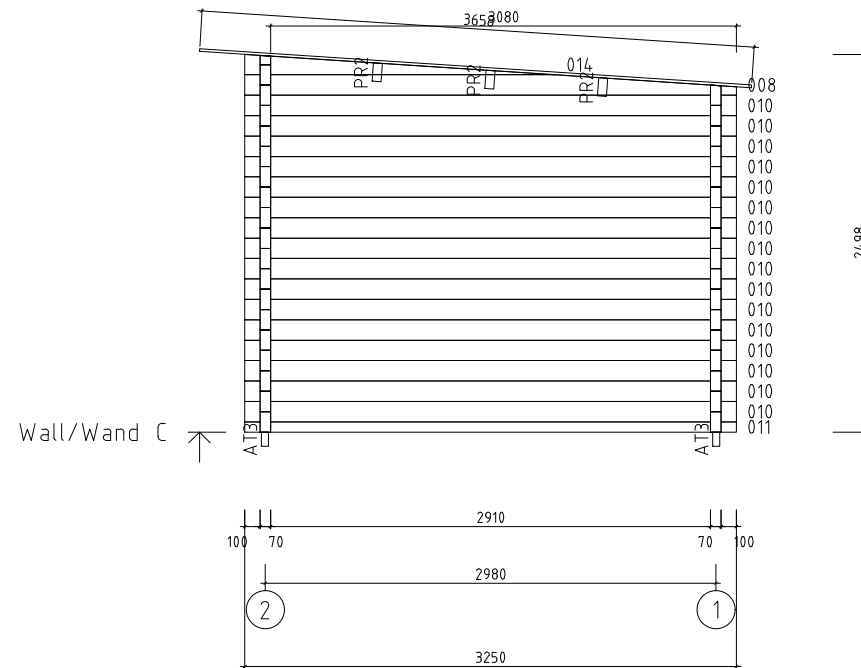

 www.hansa24.com	Name		Aaron 595x325 70		SKU	G0392
	Drawing/Zeichnung		Wall/Wand C		Format	A4
	Profile/Profil	7x13.5	Scale/Maßstab	1:50	Date	22.05.2024

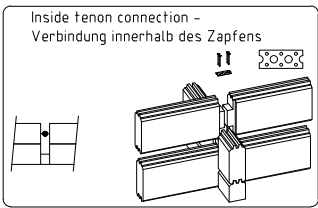
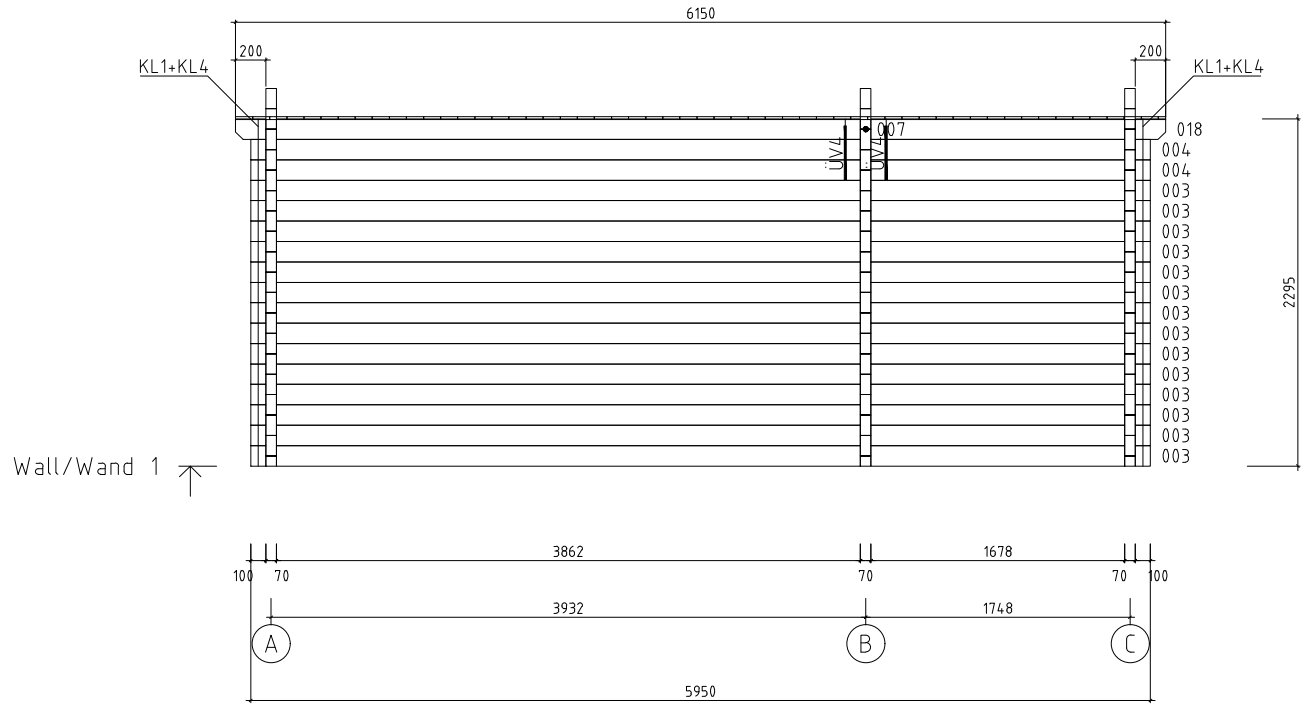
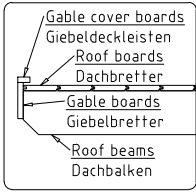

 www.hansa24.com	Name		Aaron 595x325 70		SKU		G0392
	Drawing/Zeichnung		Wall/Wand 1		Format		A4
	Profile/Profil	7x13.5	Scale/Maßstab	1:50	Date	22.05.2024	

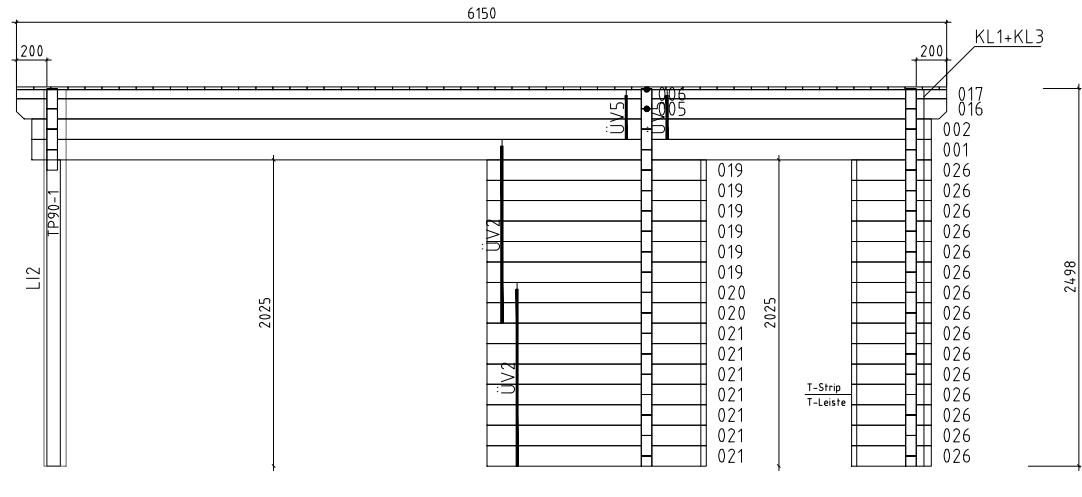

Wall/Wand 2 ↗

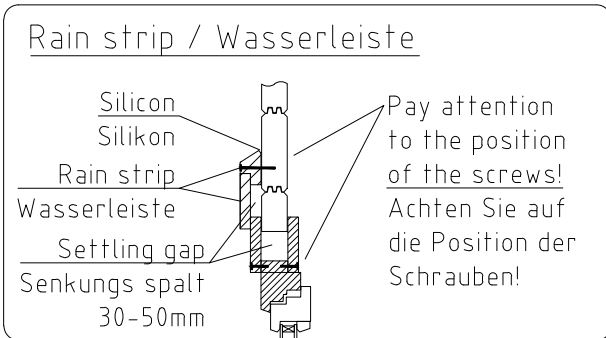
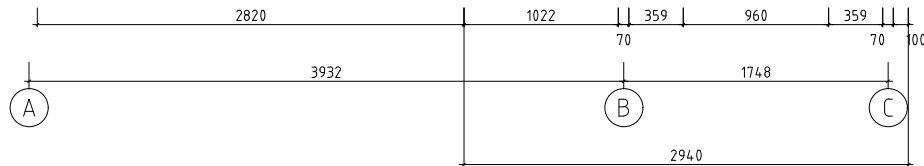
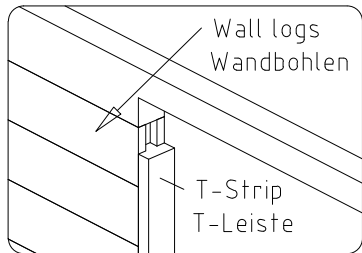

 www.hansa24.com	Name Aaron 595x325 70		SKU G0392
	Drawing/Zeichnung Wall/Wand 2		Format A4
	Profile/Profil 7x13.5	Scale/Maßstab 1:50	Date 22.05.2024