

 www.hansa24.com	Name	Roberta 686x385 70	SKU	G0396
	Drawing/Zeichnung	3D		Format
	Profile/Profil	7.0x13.5	Scale/Maßstab	Date

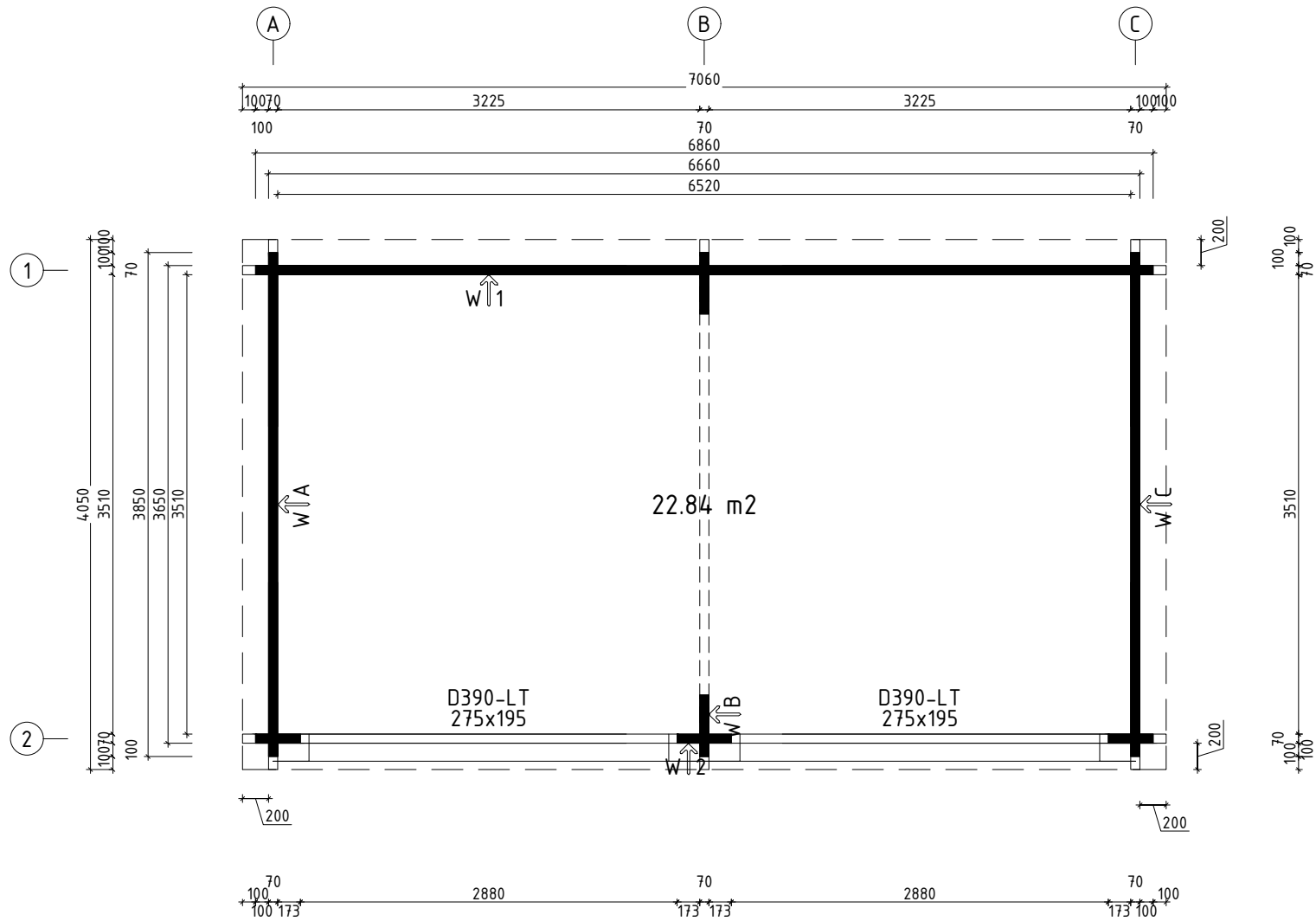

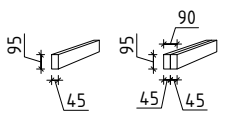

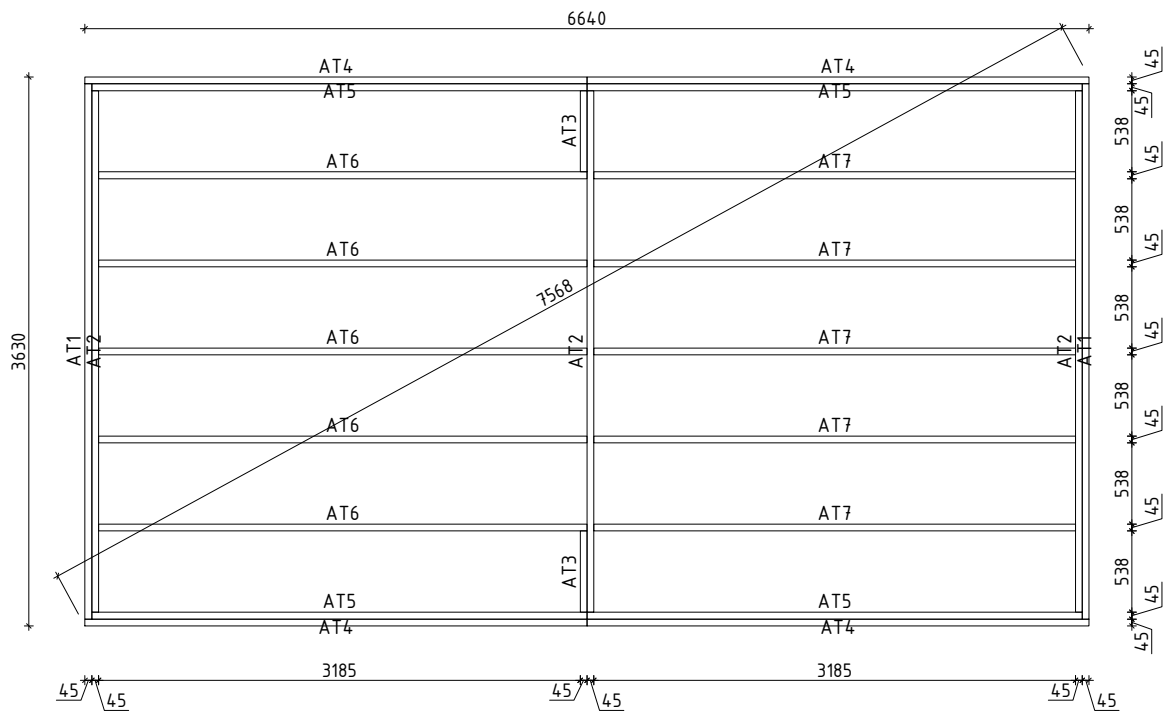



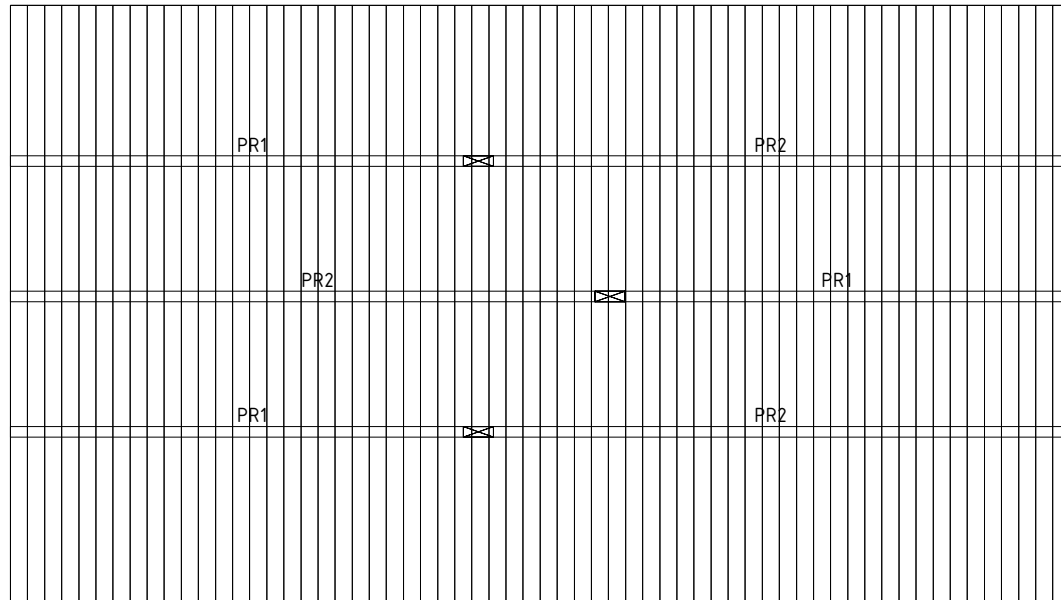

Name	Roberta 686x385 70	SKU	G0396
Drawing/Zeichnung	Plan_Grundplan	Format	A4
Profile/Profil	7.0x13.5	Scale/Maßstab	1:50
Date	22.05.2024		

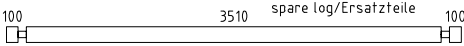
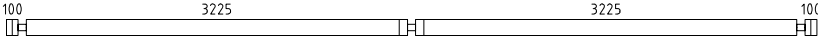
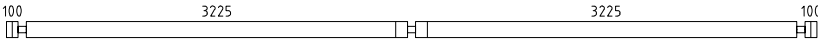
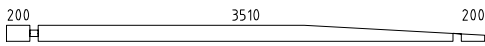
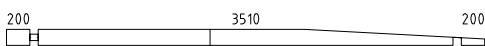
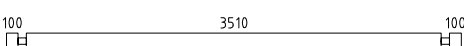
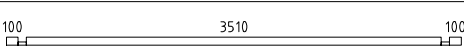
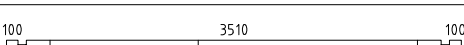
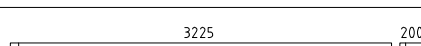
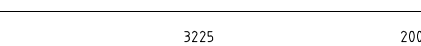
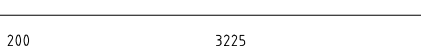
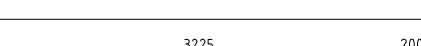
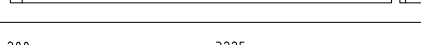
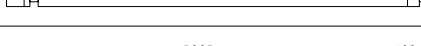
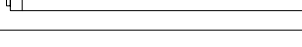
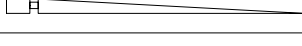







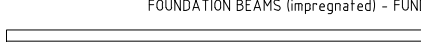
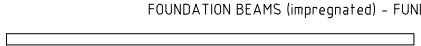



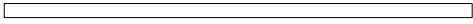

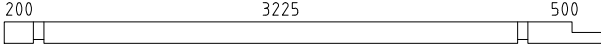
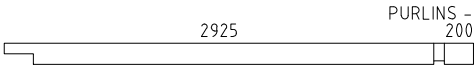
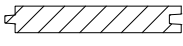
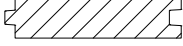



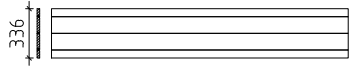
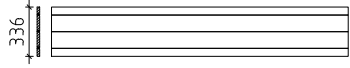
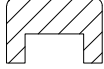

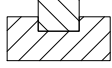
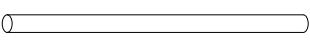

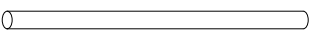











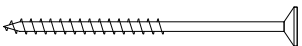
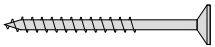
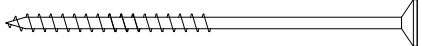

 www.hansa24.com	Name Roberta 686x385 70		SKU G0396
	Drawing/Zeichnung Foundation plan_Lagerholzplanoundat		Format A4
	Profile/Profil 7.0x13.5	Scale/Maßstab 1:50	Date 22.05.2024





 www.hansa24.com	Name		Roberta 686x385 70	SKU	G0396
	Drawing/Zeichnung		Roof plan_Dachplan	Format	A4
	Profile/Profil	7.0x13.5	Scale/Maßstab	1:50	Date

Pos	Model Roberta 686x385 70	Pcs	Profile (mm)	Length (mm)
	Notice! The gable pieces can be partly pre-assembled! Please notice - those differ from the description given in the specification list.			
	Achtung! Die Giebelbohlen können teilweise schon vormontiert sein! Bitte beachten - diese erscheinen nicht ganz so wie in der Teilleiste beschrieben.			
	✓ - Cut into length on site (if needed)! / Bitte selber anpassen (falls nötig)!			
005	 spare log/Ersatzteile	1	70x135	3850
001		1	70x135	6860
002		4	70x135	6860
003		2	70x135	4050
004		1	70x135	4050
005		30	70x135	3850
006		2	70x68	3850
007		1	70x135	3850
008		2	70x135	3530
009		1	70x57	3530
010		1	70x57	3530
011		1	70x135	3530
012		1	70x135	3530
013		22	70x135	3430
014		2	70x135	2520
015		1	70x135	2520
016		10	70x135	470
017		4	70x135	470
018		14	70x135	470
019		2	70x68	470
020		14	70x135	415
021		1	70x135	415
022		30	70x135	343
AT1	FOUNDATION BEAMS (impregnated) - FUNDAMENTHÖLZER (imprägniert) 	2	45x95	3540
AT2	FOUNDATION BEAMS (impregnated) - FUNDAMENTHÖLZER (imprägniert) 	3	45x95	3450
AT4	FOUNDATION BEAMS (impregnated) - FUNDAMENTHÖLZER (imprägniert) 	4	45x95	3320
Kood	Roberta 686x385 70	Materjal	File	Leht 1/4

Pos	Model Roberta 686x385 70	Pcs	Profile (mm)	Length (mm)
AT5	FOUNDATION BEAMS (impregnated) - FUNDAMENTHÖLZER (imprägniert) 	4	45x95	3275
AT6	FOUNDATION BEAMS (impregnated) - FUNDAMENTHÖLZER (imprägniert) 	5	45x95	3230
AT7	FOUNDATION BEAMS (impregnated) - FUNDAMENTHÖLZER (imprägniert) 	5	45x95	3185
AT3	FOUNDATION BEAMS (impregnated) - FUNDAMENTHÖLZER (imprägniert) 	2	45x95	538
PR2	PURLINS - PFETTEN 	3	70x145	4065
PR1	PURLINS - PFETTEN 	3	70x145	3195
	ROOF BOARDS - DACHBRETTER 	63+1	113x18	3956
	FLOOR BOARDS - FUSSBODENBRETTER 	58+1	113x28	3505
	Ceiling mouldings - Deckenleisten (inside and outside - innen und außen) ✓ 		15x28	50 rm/lfm
	Floor mouldings - Fussbodenleisten ✓ 		14x55	22 rm/lfm
RLI01-1	Eave slat - Traufenleiste 18x40 ✓ 		18x40	16 rm/lfm
KAR1-1	Parapet - Blende 336 (front and back) 	4	18x336	3548
KAR1-2	Parapet - Blende 336 (sides) 	2	18x336	4056
KAR2-1	Parapet cover - U-Profil für Blenden ✓ 		44x65	26 rm/lfm
KAR3-1	Parapet support - Blendestütze 44x65 	12	44x65	200
KAR4-1	Parapet- connecting slat - Blende- Verbindungsleiste 	2	18x120	330
	T-strip - T-Leiste 70 	4		1965
ÜV1	Metal bar - Metallstange Ø10 	2	Ø10	1240
ÜV2	Metal bar - Metallstange Ø10 	6	Ø10	1040
ÜV3	Metal bar - Metallstange Ø10 	2	Ø10	420
ML01	Connecting strip for wall logs - Verbindungsstreifen für Wandbalken 	14		
LK	Hit block - Schlaghölzer 	3		
N-0 2503	Nails - Nägel 2.5x60 for floor boards - für Fussbodenbretter 	812		
Kood	Roberta 686x385 70	Materjal	File	Leht 2/4

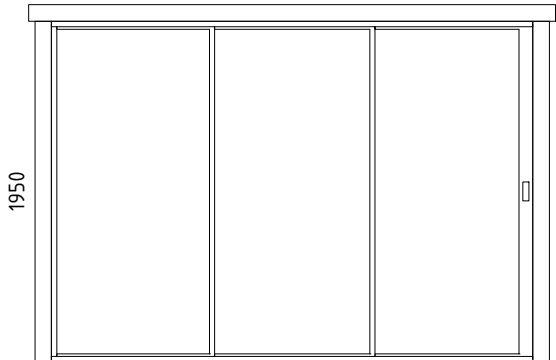
Pos	Model Roberta 686x385 70		Pcs	Profile (mm)	Length (mm)
N-0 2501	Nails - Nägel vierkant 2.5x50 for ceiling boards - für Dachbretter		630		
KR-0 3001	Screws - Schrauben 3.0x30 for ceiling mouldings - für Deckenleisten		94		
KR-0 3002	Screws - Schrauben 3.0x30 for eave slats - für Traufenleisten		32		
KR-0 3003	Screws - Schrauben 3.0x30 for floor mouldings - für Fussbodenleisten		42		
KR-0 3004	Screws - Schrauben 3.0x30 for parapet connecting slat - für Verbindungsleiste des Blendes		16		
KR-0 3522	Screws - Schrauben 3.5x45 C3 for connecting strip for wall logs - für Verbindungsstreifen für Wandbalken		56		
KR-0 3529	Screws - Schrauben 3.5x45 C3 for U-profile - für U-Profil		52		
KR-0 5080	Screws - Schrauben 5.0x100 for foundation beams - für Fundamenthölzer		100		
KR-0 5031	Screws - Schrauben 5.0x70 C3 for parapet fastening - für Blendenbefestigung		56		
KR-0 6021	Screws - Schrauben 6.0x140 for parapet supports - für Blendestützen		24		
KL1	Threaded rod - Gewindestange M8		4		2000
KL2	Threaded rod - Gewindestange M8		1		435
KL3	Threaded rod - Gewindestange M8		2		382
KL4	Threaded rod - Gewindestange M8		2		190
KL03-1	Threaded rod for purlins - Gewindestange für die Pfetten M12		6		145
M03	Nut for purlins - Mutter für die Pfetten M12		12		
SE32	Washer for purlins - Scheibe für die Pfetten M12x37		12		
	Nut - Mutter M8		5		
	Washer - Scheibe M8x24		5		
	Extended nut - Langmutter M8		4		
	Drive-in nut - Einschlagmutter M8		5		
Kood	Roberta 686x385 70	Materjal	File	Leht	3/4

Pos	Model Roberta 686x385 70	Pcs	Profile (mm)	Length (mm)	
	DOOR 2750x1950 D0-UXXL-0XT-27501950  D390-LT Left handed - DIN Links Tempered glass - Gehärtetes Glas Opens outside - Öffnet aussen	2			
VIHM 01-1	Rain deflector - Regenabweiser		2	36x134	3014
DF39	Door frame for D390 - Türrahmen für D390		2		
KR-0 4001	Screws - Schrauben 4.0x60 C3 for rain deflector - für Regenabweiser		14		
Kood	Roberta 686x385 70	Materjal	File	Leht	4/4

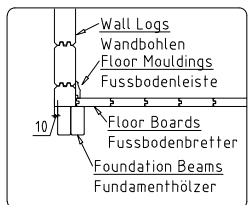
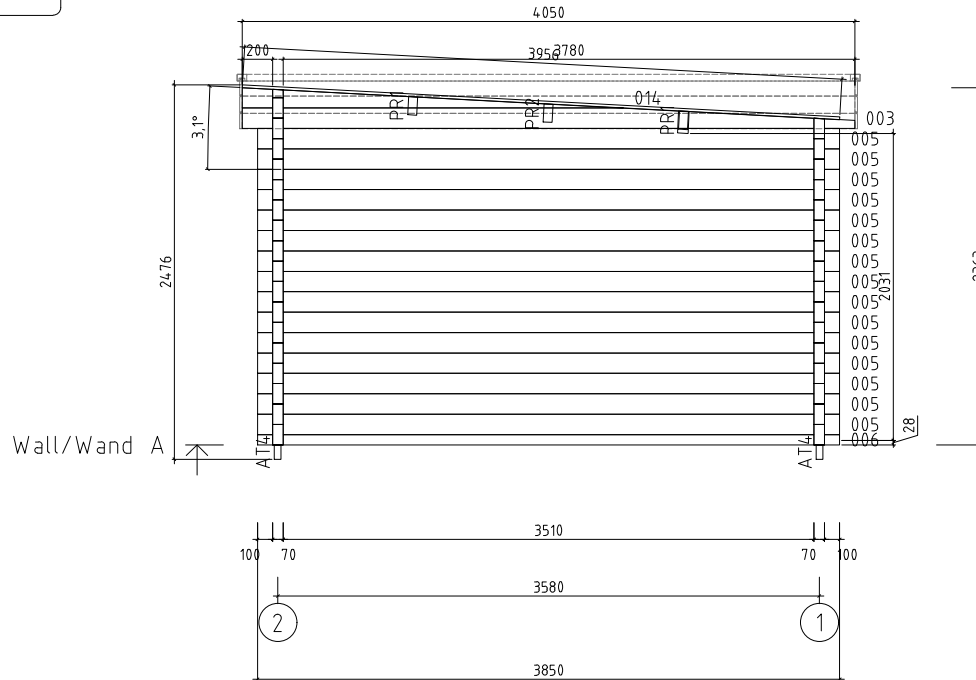
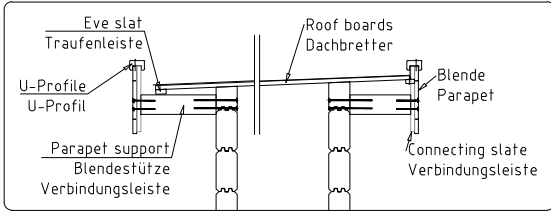

 www.hansa24.com	Name		Roberta 686x385 70	SKU	G0396
	Drawing/Zeichnung		Wall/Wand A	Format	A4
Profile/Profil	7x13.5	Scale/Maßstab	1:50	Date	22.05.2024

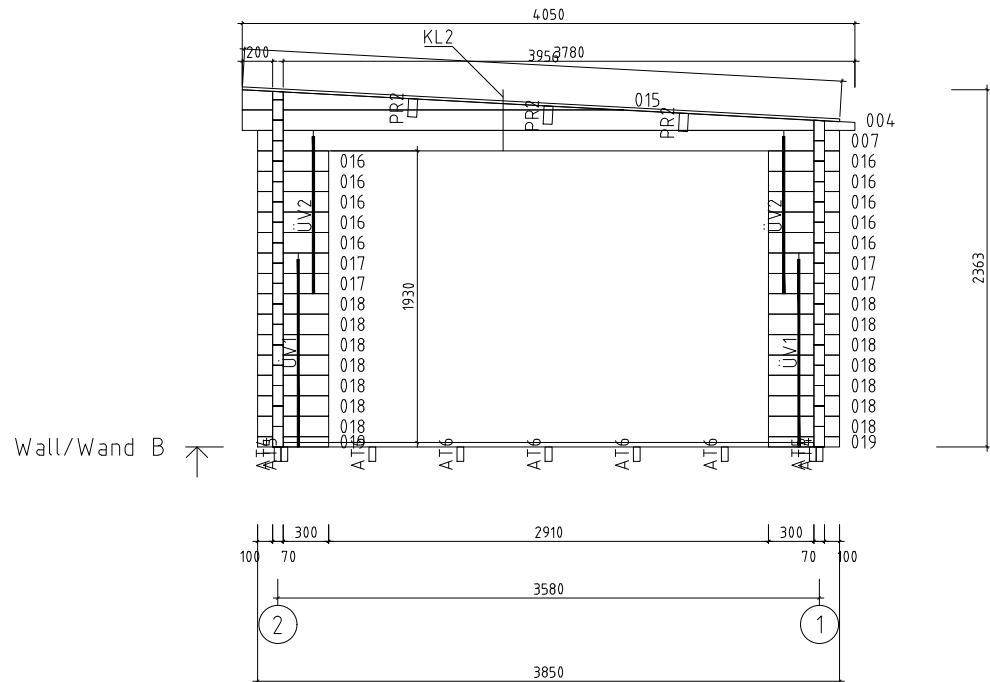

 www.hansa24.com	Name		Roberta 686x385 70		SKU	G0396
	Drawing/Zeichnung		Wall/Wand B		Format	A4
	Profile/Profil	7x13.5	Scale/Maßstab	1:50	Date	22.05.2024

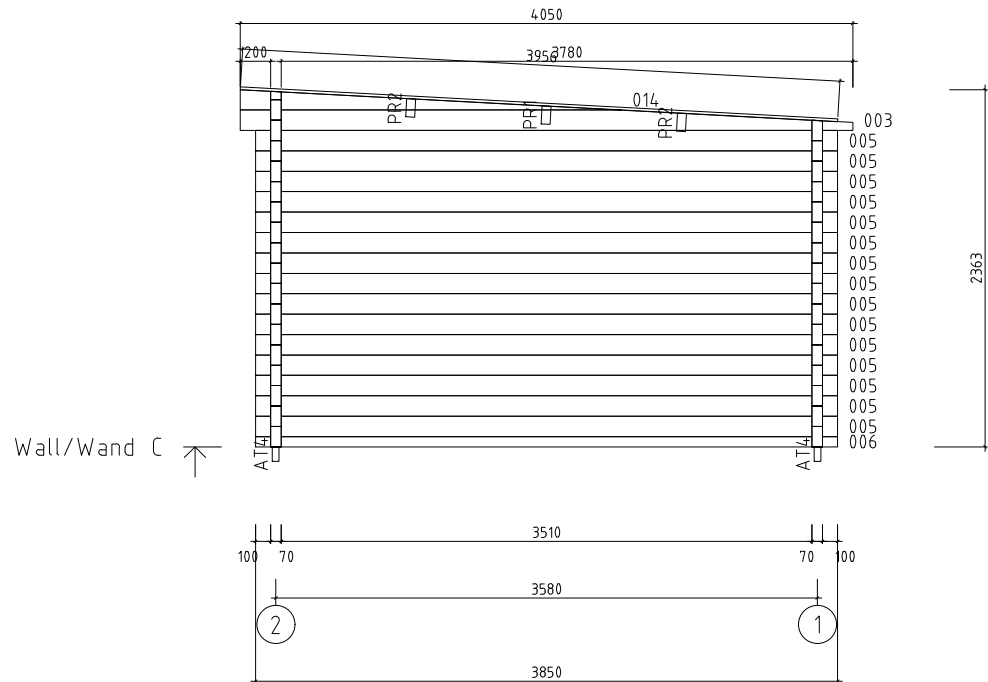

 www.hansa24.com	Name		Roberta 686x385 70		SKU	G0396
	Drawing/Zeichnung		Wall/Wand C		Format	A4
	Profile/Profil	7x13.5	Scale/Maßstab	1:50	Date	22.05.2024

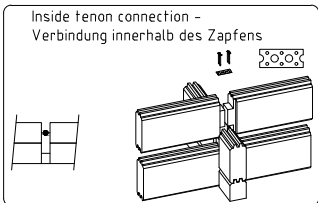
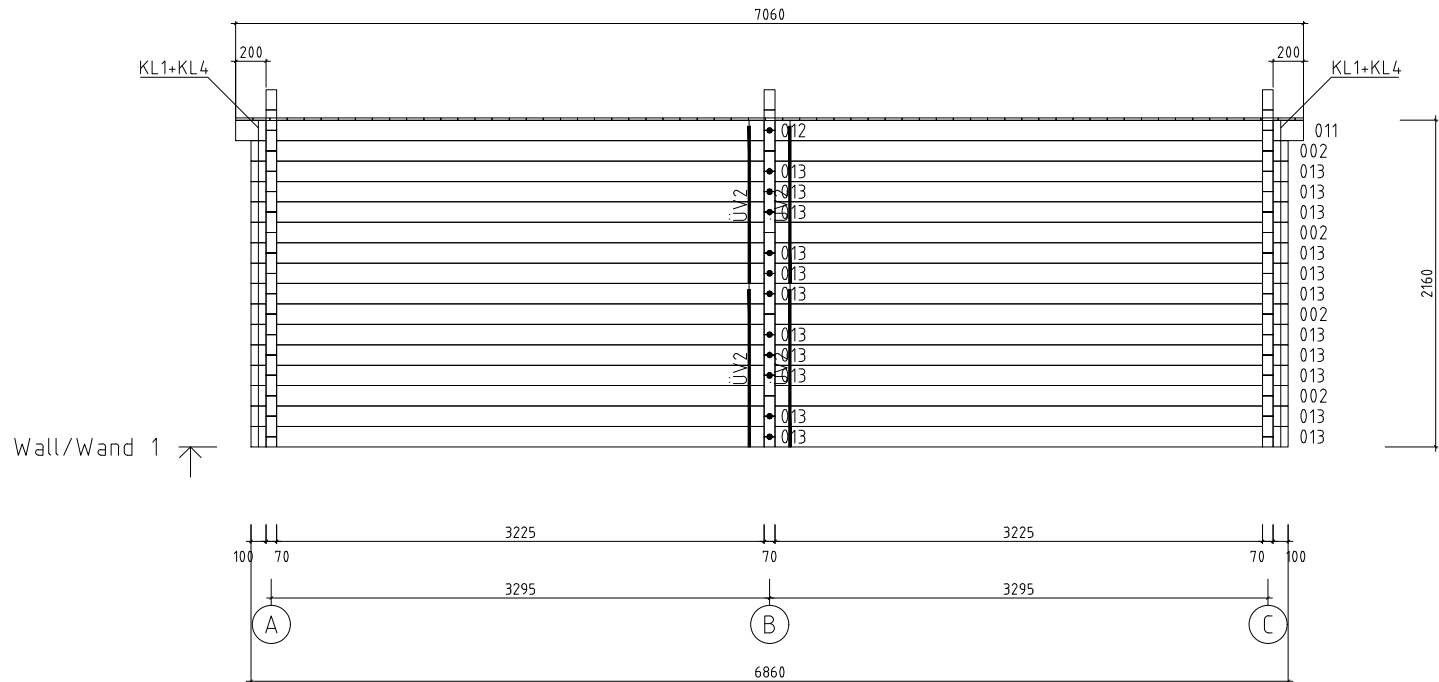

 www.hansa24.com	Name		Roberta 686x385 70		SKU	G0396
	Drawing/Zeichnung		Wall/Wand 1		Format	A4
Profile/Profil	7x13.5	Scale/Maßstab	1:50	Date	22.05.2024	

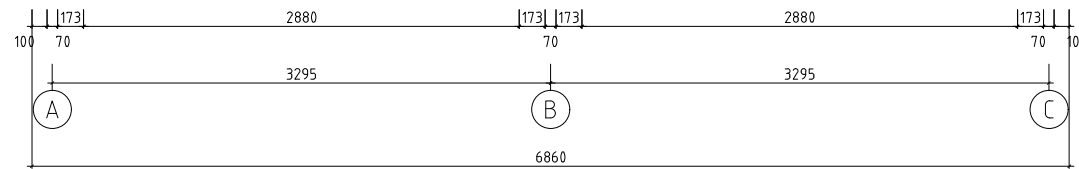
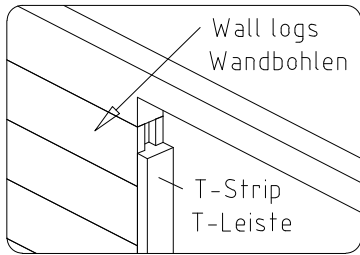
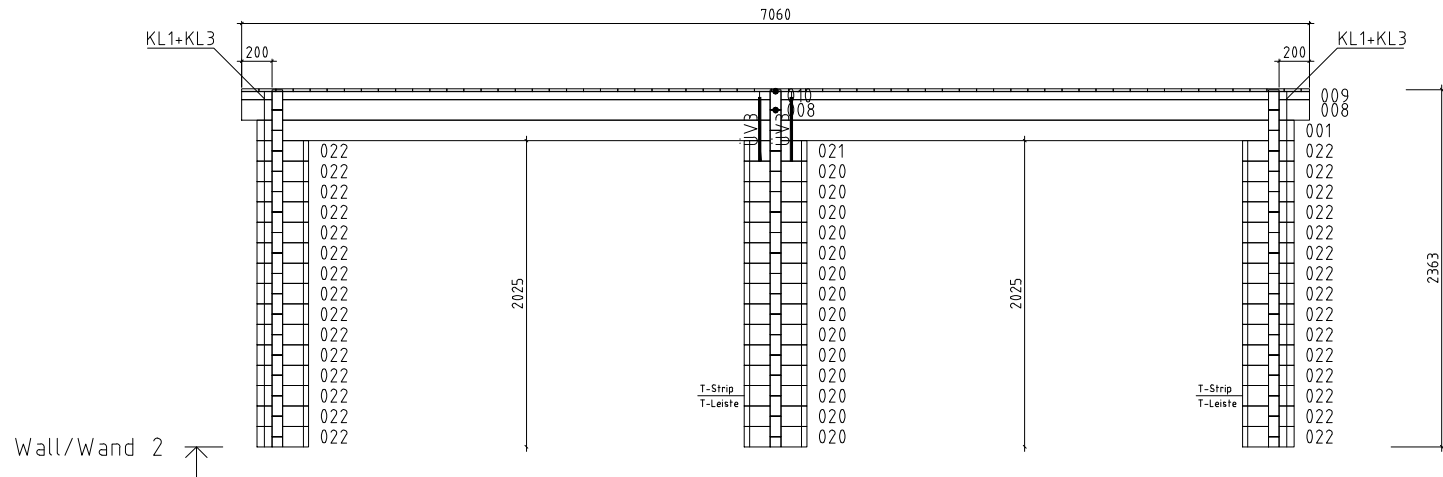

Rain strip / Wasserleiste

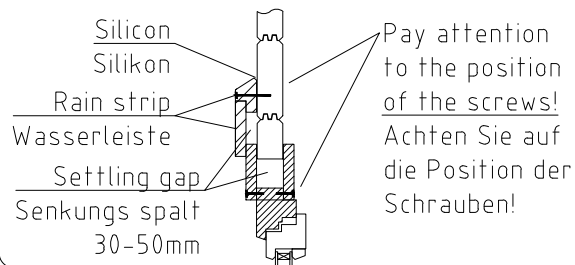

 www.hansa24.com	Name		Roberta 686x385 70	SKU	G0396
	Drawing/Zeichnung		Wall/Wand 2	Format	A4
Profile/Profil	7x13.5	Scale/Maßstab	1:50	Date	22.05.2024