

Name	Carport 350x700 70		
Zeichnung/Drawing	3D		
Profil/Profile	7x13.5	Datum/Date	16.08.2023

H = 1.500 m
 TOTAL: 20.82 m²

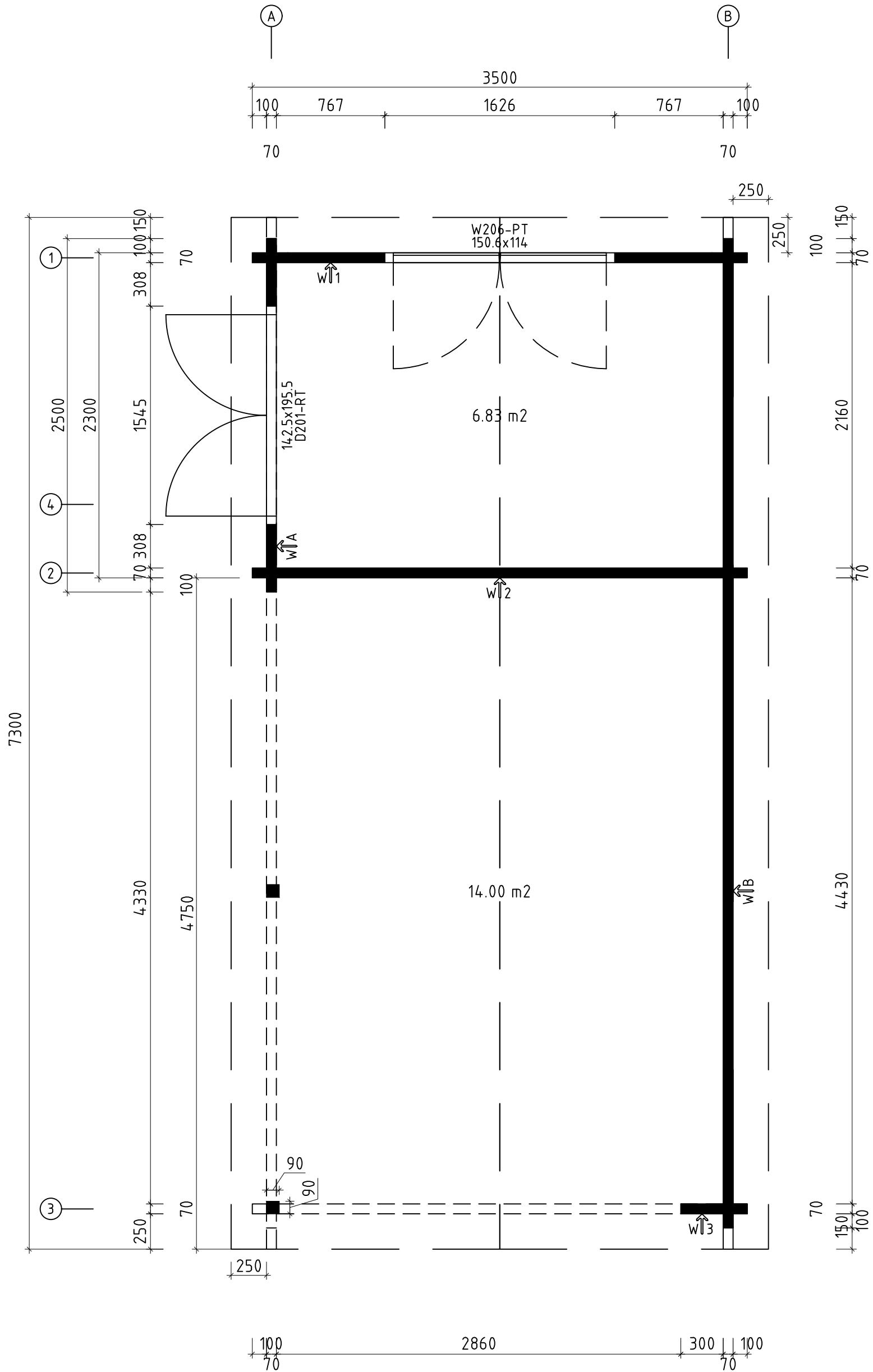



* Fenster und Türen sind mit Sprossen/
 Windows and doors are with muntins



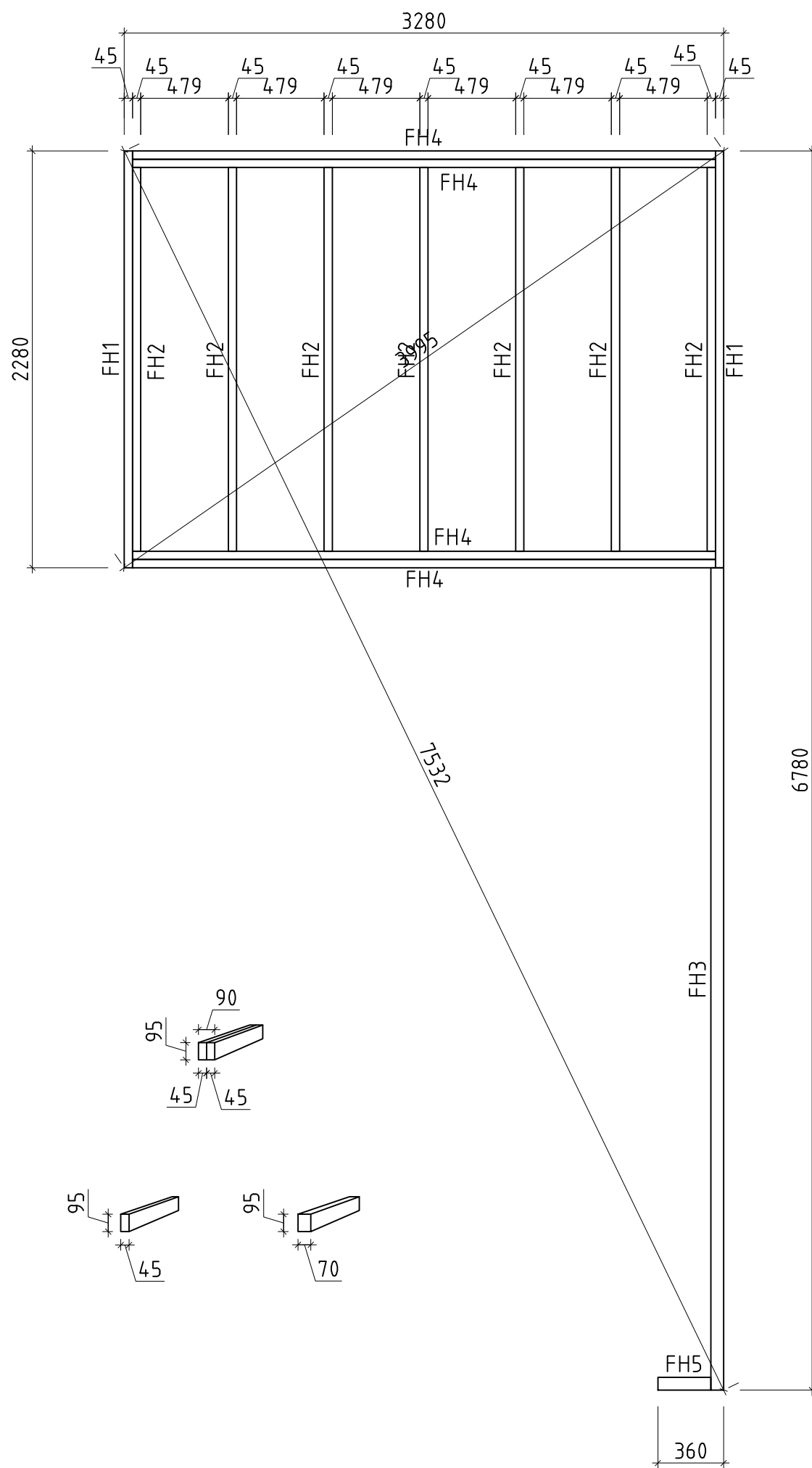



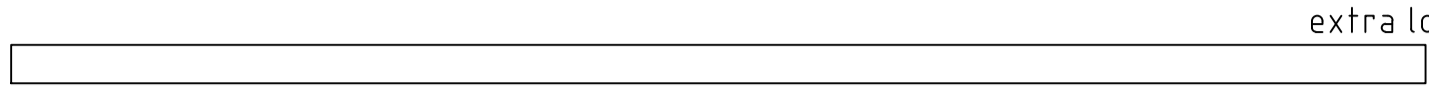
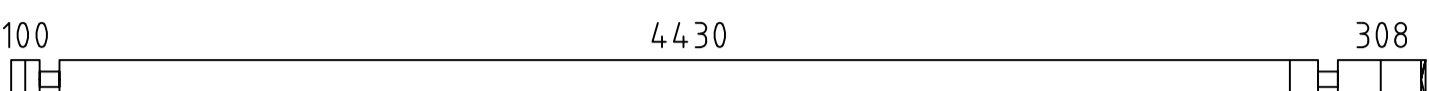
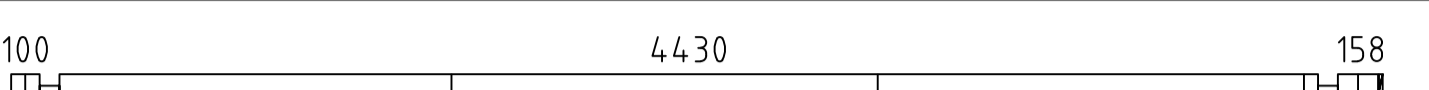
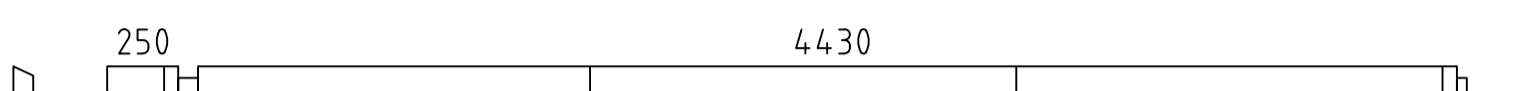
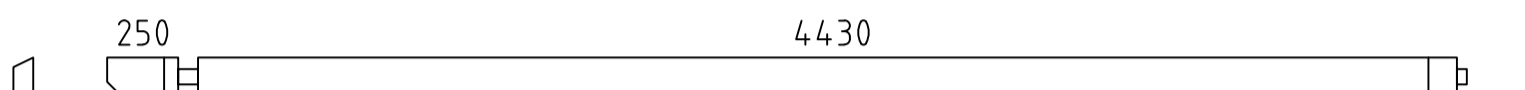
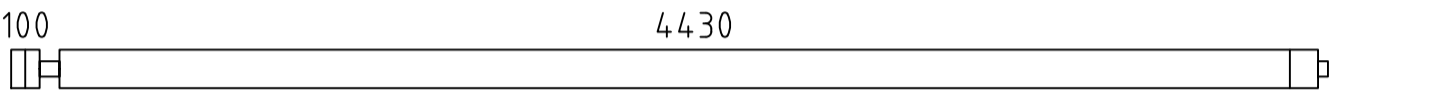
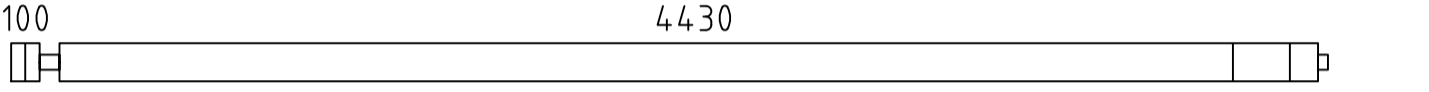
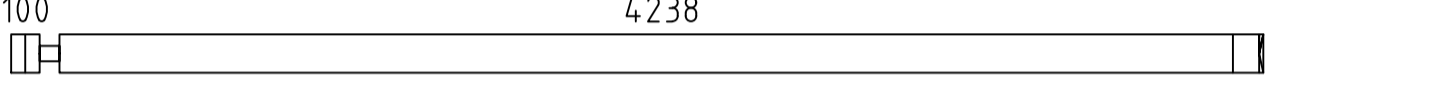
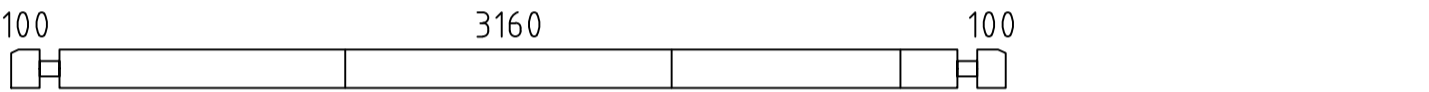
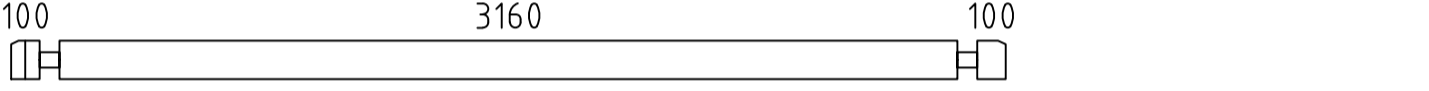
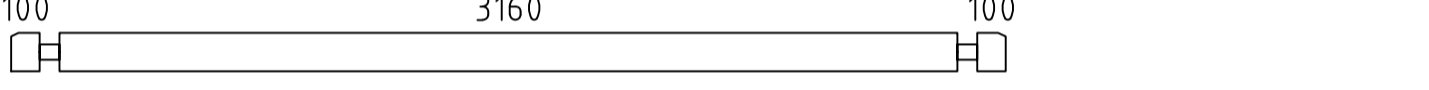
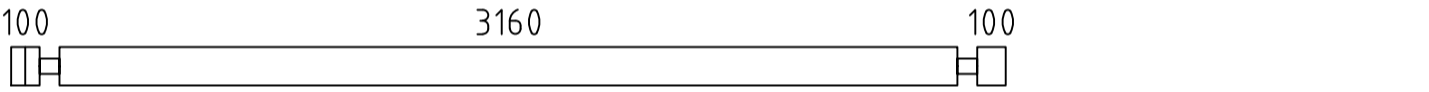
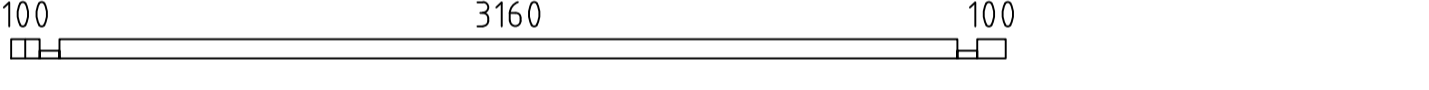

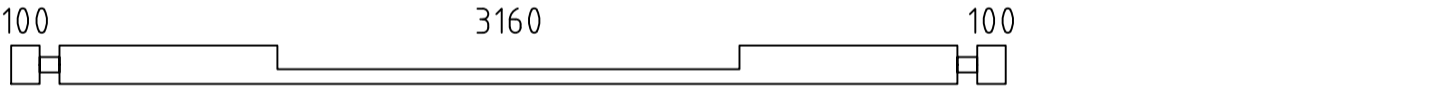
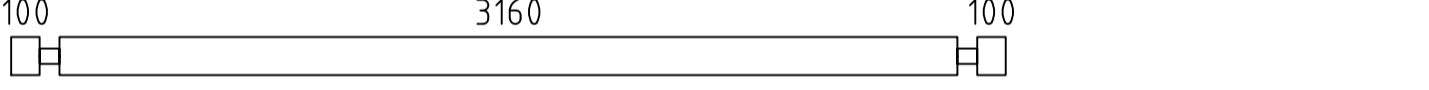
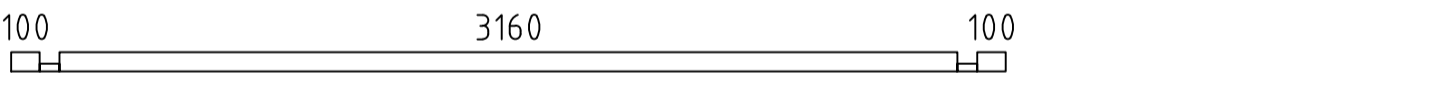
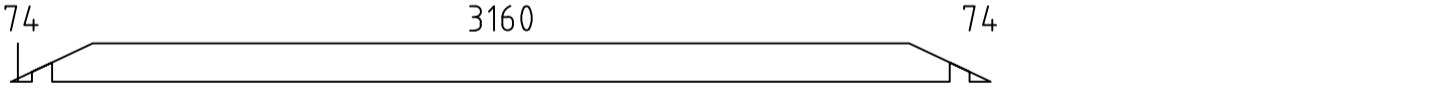
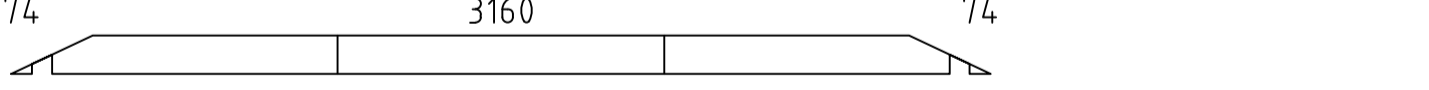
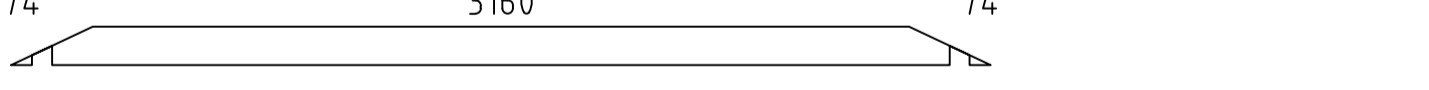
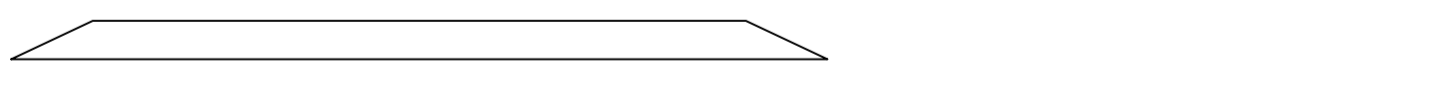
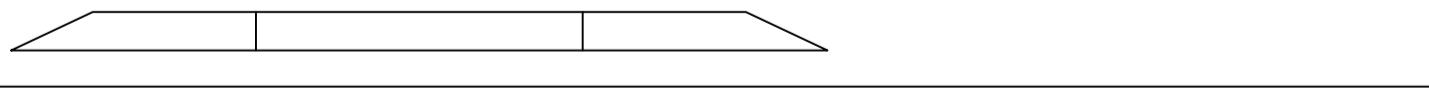
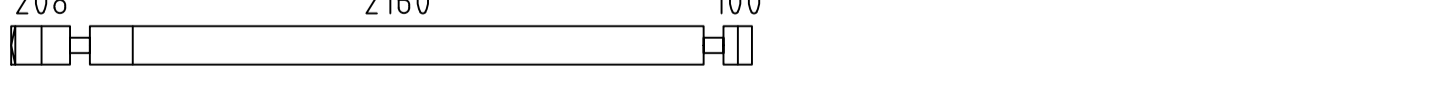
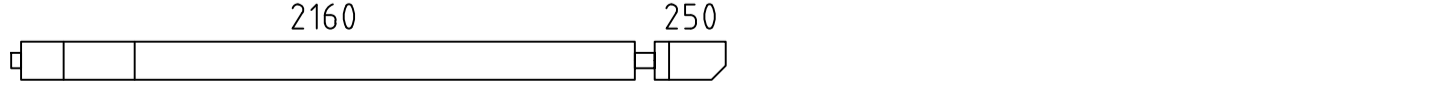
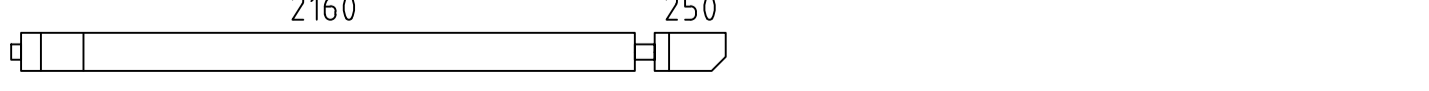
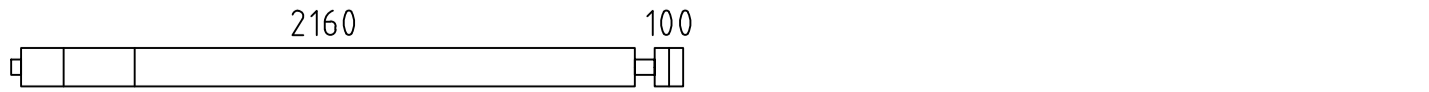

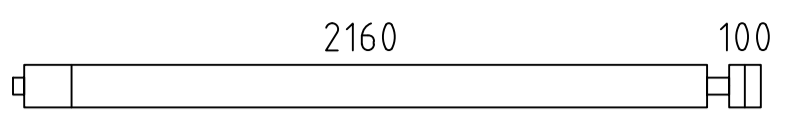
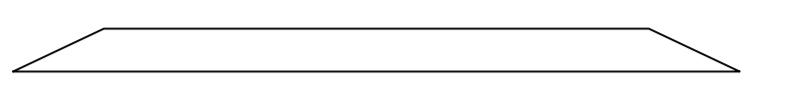
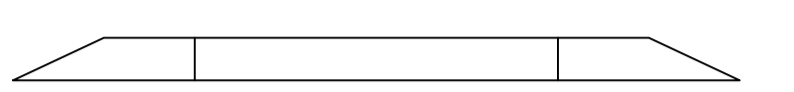
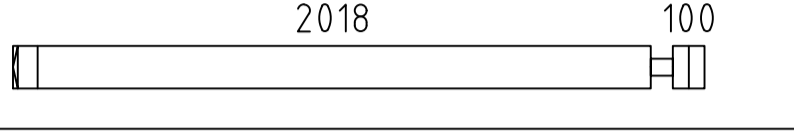
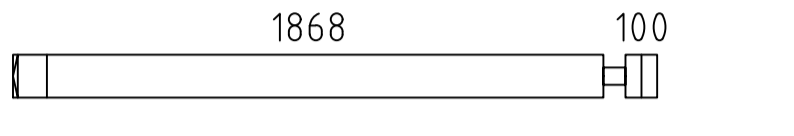
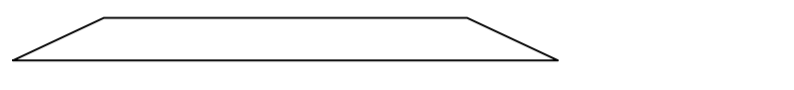
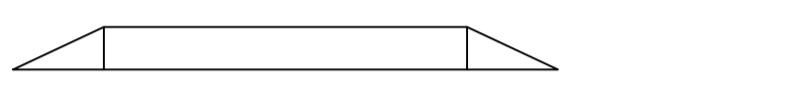



Q4 – Qualitätsklasse für Fenster und Türen/
 Quality class for windows and doors









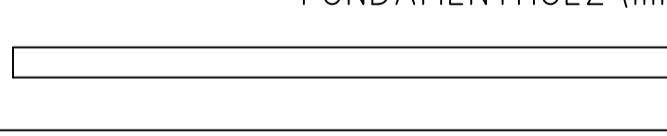
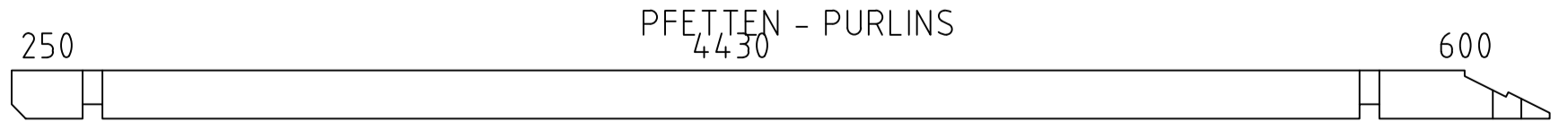
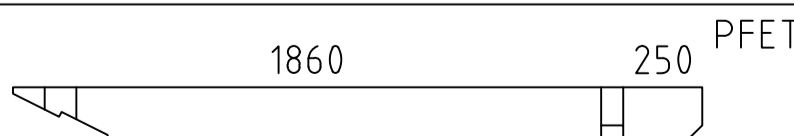
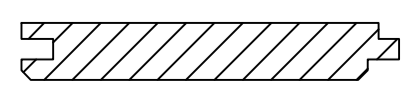

Name	Carport 350x700 70		
Zeichnung/Drawing	Grundplan_Plan		
Profil/Profile	7x13.5	Datum/Date	16.08.2023

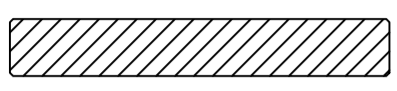
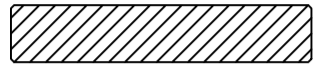

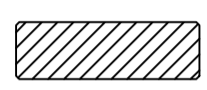
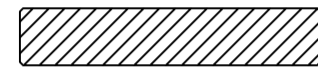

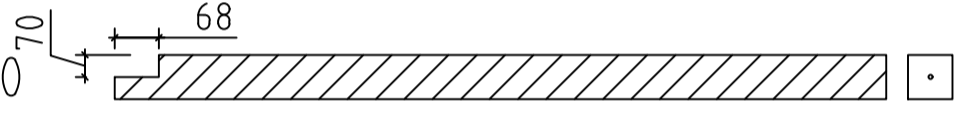
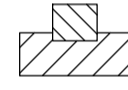
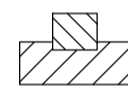
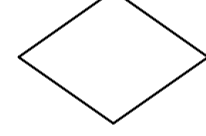
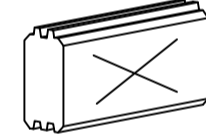
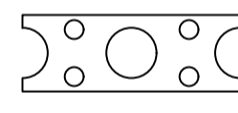
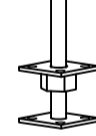
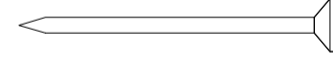
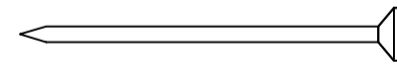
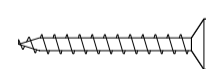
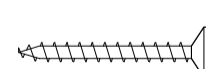
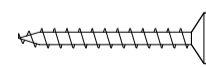
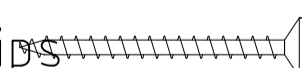



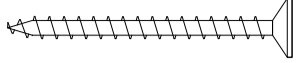
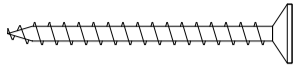
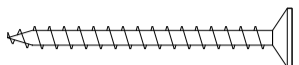
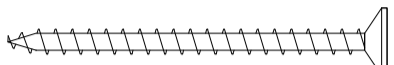
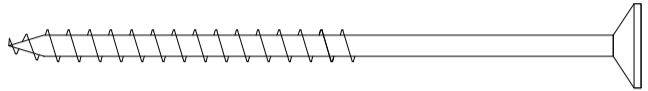
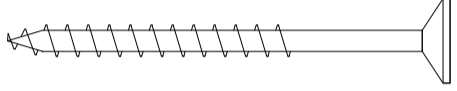

Name	Carport 350x700 70		
Zeichnung/Drawing	Lagerholzplan_Foundation beams		
Profil/Profile	7x13.5	Datum/Date	16.08.2023

Pos	Teileliste/Specification Carport 350x700 70	Stck. Pcs.	Profil Profile (mm)	Länge Length (mm)
	<u>Achtung!</u> Die Giebelbohlen können teilweise schon vormontiert sein! Bitte beachten - diese erscheinen nicht ganz so wie in der Teileliste beschrieben.			
	<u>Notice!</u> The gable pieces can be partly pre-assembled! Please notice - those differ from the description given in the specification list.			
000		1	70x135	4977
001		3	70x135	4977
002		1	70x135	4827
003		1	70x135	4785
004		1	70x135	4785
005		7	70x135	4635
006		4	70x135	4635
007		2	70x135	4407
008		1	70x135	3500
009		1	70x135	3500
010		1	70x135	3500
011		15	70x135	3500
012		1	70x68	3500
013		1	70x135	3500
014		1	70x135	3500
015		5	70x135	3500
016		1	70x68	3500
017		1	70x135	3447
018		1	70x135	3447
019		1	70x135	3447
020		2	70x135	2873
021		1	70x135	2873
022		2	70x135	2608
023		1	70x135	2515
024		1	70x135	2515
025		5	70x135	2365
Kood	Carport 350x700 70	Materjal	File	Leht 1/5

Pos	Teileliste/Specification Carport 350x700 70	Stück Pcs.	Profil Profile (mm)	Länge Length (mm)
026		6	70x135	2365
027		2	70x135	2298
028		1	70x135	2298
029		1	70x135	2188
030		3	70x135	2038
031		2	70x135	1724
032		1	70x135	1724
033		3	70x135	1149
034		16	70x135	937
035		1	70x135	478
036		15	70x135	478
037		14	70x135	478
038		8	70x135	470
039		4	70x135	470
040		3	70x135	470
041		1	70x68	470
042		6	70x124	263
FH3	FUNDAMENTHOLZ (imprägniert) - FOUNDATION BEAM (impregnated) 	1	70x95	4500
FH5	FUNDAMENTHOLZ (imprägniert) - FOUNDATION BEAM (impregnated) 	1	70x95	290
FH4	FUNDAMENTHOLZ (imprägniert) - FOUNDATION BEAM (impregnated) 	4	45x95	3190
FH1	FUNDAMENTHOLZ (imprägniert) - FOUNDATION BEAM (impregnated) 	2	45x95	2280
FH2	FUNDAMENTHOLZ (imprägniert) - FOUNDATION BEAM (impregnated) 	7	45x95	2100
PF1	PFETTEN - PURLINS 	3	58x170	5420
PF2	PFETTEN - PURLINS 	3	58x170	2180
	DACHBRETTER - ROOF BOARDS 	130+2	113x18	2099
Kood	Carport 350x700 70	Materjal	File	Leht 2/5

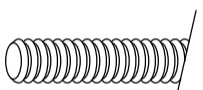
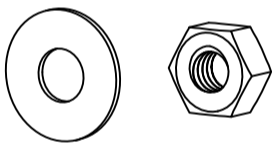
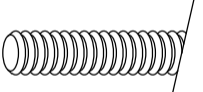
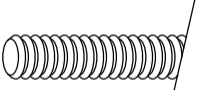
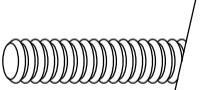
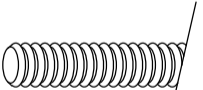
Pos	Teileliste/Specification Carport 350x700 70		Stck. Pcs.	Profil Profile (mm)	Länge Length (mm)
	FUSSBODENBRETTER - FLOOR BOARDS		20+1	113x28	3155
	FUSSBODENLEISTEN - FLOOR STRIPS	 ✓		14x55	12.0 lfm/rm
	DECKENLEISTEN - CEILING STRIPS	 ✓		15x28	38.0 lfm/rm
G02-1	GIEBELBRETTER - GABLE BOARDS 18x120	25.2°  ✓	4	18x120	2179
G01-1	GIEBELBRETTER - GABLE BOARDS 18x95	25.2°  ✓	4	18x95	2179
G06-1	GIEBELDECKLEISTEN - GABLE COVER STRIPS 18x58	 ✓	4	18x58	2179
G08-1	GIEBELLEISTEN - GABLE STRIPS 18x58	25.2°  ✓	4	18x58	2179
T01-1	TRAUFBRETTER - EAVES BOARDS 18x95		4	18x95	3650
T06-1	TRAUFNLEISTEN - EAVES STRIPS 18x40	 ✓		18x40	15.0 lfm/rm
TP90-1	STÜTZPFOSTE - SUPPORT POST 90x90	 ✓	2	90x90	2093
TL70-1	T-LEISTEN - T-STRIPS 70		2	45x70	1030
TL70-2	T-LEISTEN - T-STRIPS 70		2	45x70	1975
GS	GIEBELSEGMENT - GABLE DIAMOND		2		
SH	SCHLAGHÖLZER - MOUNTING PIECES		3		
VS	Verbindungsstreifen für verbinden der Wandbohlen - Connecting strip for connecting the wall parts		13		
VP2	Verstellbare Pfostenstütze - Adjustable post support M16		2		
NG2 550	NÄGEL - NAILS 2.5x50 Dachbretter - Roof boards		780		
NG2 560	NÄGEL - NAILS 2.5x60 Fussbodenbretter - Floor boards		280		
SR3 030	Schrauben - Screws 3.0x30 Deckenleisten - Ceiling strips		76		
SR3 030	Schrauben - Screws 3.0x30 Fussbodenleisten - Floor strips		22		
SR3 030	Schrauben - Screws 3.0x30 Traufenleisten - Eaves strips		32		
SR37	Schrauben - Screws 3.5x45 Tür/Fensterleisten - Door/Window strips		52		
SR3 545	Schrauben - Screws 3.5x45 Giebelbretter - Gable boards		48		
SR3 545	Schrauben - Screws 3.5x45 Giebeldeckleisten - Gable cover strips		24		
SR3 545	Schrauben - Screws 3.5x45 Giebelleisten - Gable strips		24		
Kood	Carport 350x700 70	Materjal	File	Leht	3/5

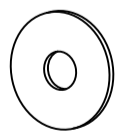
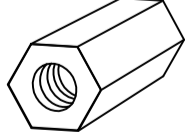
Pos	Teileliste/Specification Carport 350x700 70			Stck. Pcs.	Profil Profile (mm)	Länge Length (mm)
SR3 545	Schrauben - Screws 3.5x45	Giebelsegment - Gable diamond		4		
SR3 545	Schrauben - Screws 3.5x45	Traufenbretter - Eaves boards		32		
SR354 5-001	Schrauben - Screws 3.5x45	Verbindungsstreifen - Connecting strip		52		
SR44	Schrauben - Screws 4.0x60	Wasserleisten - Rain strips WL1		8		
SR5 0100	Schrauben - Screws 5.0x100	Fundamenthölzer - Foundation beams		60		
SR5 070	Schrauben - Screws 5.0x70	Stützpfole - Support post		12		
ML1	Metallstange - Metal bar			2	D10	1170
ML2	Metallstange - Metal bar			2	D10	1040
ML3	Metallstange - Metal bar			2	D10	900
ML4	Metallstange - Metal bar			1	D10	830
ML5	Metallstange - Metal bar			2	D10	770
ML6	Metallstange - Metal bar			4	D10	360
KL-1	Gewindestange - Threaded rod M12- für die Pfetten - for purlins			6		170
MUT26	Mutter - Nut M12 U-Scheibe - Washer Ø30- für die Pfetten - for purlins			12		
KL1	Gewindestange - Threaded Rod M8			4		2000
KL2	Gewindestange - Threaded Rod M8			2		675
KL3	Gewindestange - Threaded Rod M8			1		393
KL4	Gewindestange - Threaded Rod M8			3		325
KL5	Gewindestange - Threaded Rod M8			3		270
KV M UT M8	Mutter - Nut M8			18		
KV S EIB M8X25	U-Scheibe - Washer M8 Ø25			18		
KV MU TJ M8	Befestigungsmutter - Fixing nut M8			4		
Kood	Carport 350x700 70	Materjal	File		Leht	4/5

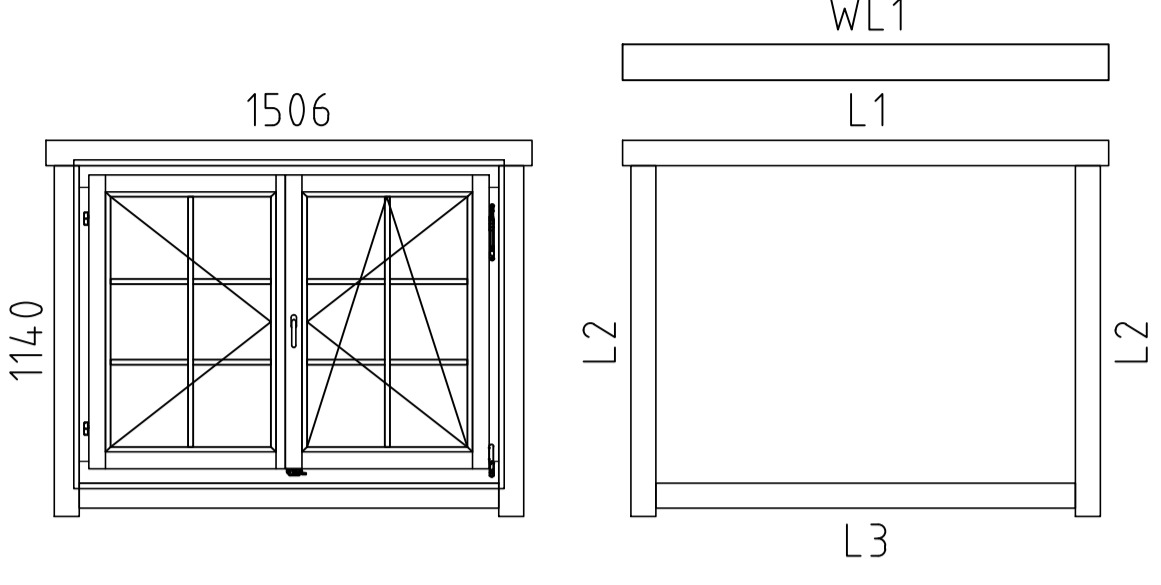
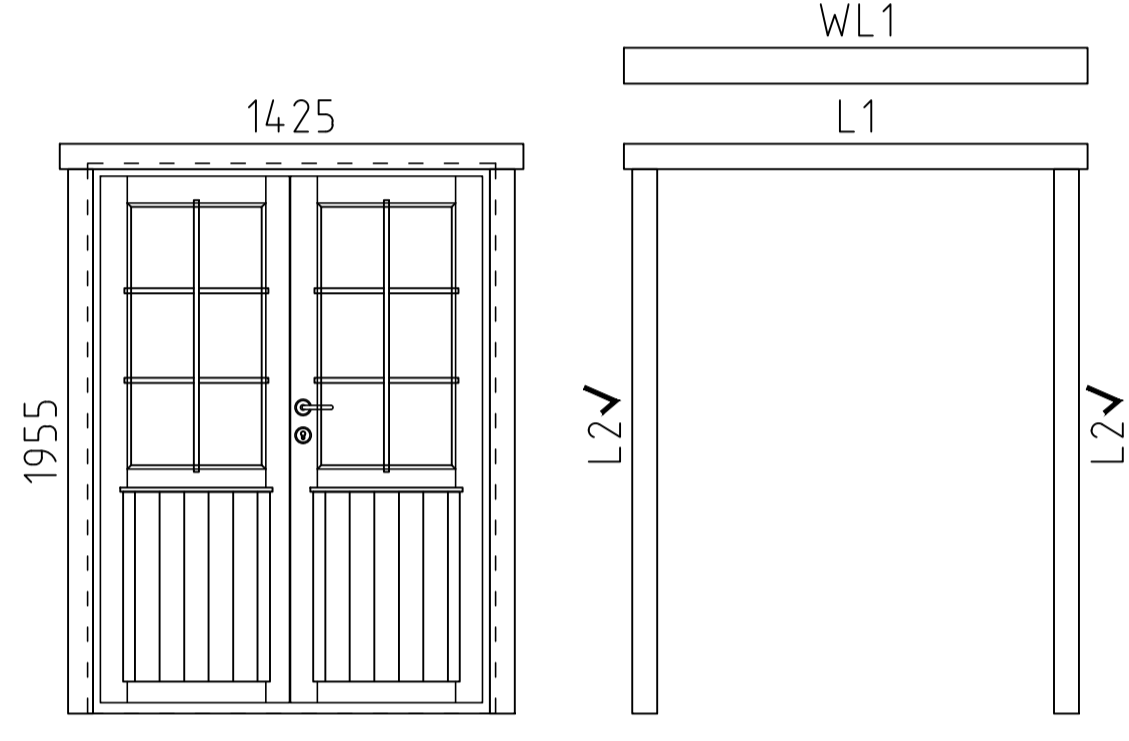
Pos	Teileliste/Specification Carport 350x700 70	Stck. Pcs.	Profil Profile (mm)	Länge Length (mm)
	<p>FENSTER/WINDOW Q4 W4-D70P-067-15061140</p>  <p>W206-PT</p> <ul style="list-style-type: none"> L1 18x90 L=1745mm 2 Stck./Pcs. L2 18x90 L=1260mm 4 Stck./Pcs. L3 18x90 L=1505mm 2 Stck./Pcs. ✓ WL1 36x129 L=1745mm 1 Stck./Pcs. 	1		
	<p>TÜR/DOOR Q4 D4-D70R-56T-14251955</p>  <p>D201-RT</p> <ul style="list-style-type: none"> L1 18x90 L=1665mm 2x L2 18x90 L=1955mm 4x ✓ WL1 36x129 L=1665mm 1x <p>DIN rechts / Right handed</p>	1		
	<p>✓ - Bitte selber anpassen (falls nötig)! / Cut into length on site (if needed)!</p>			

Montageanleitung für T-Leisten / Installing the door and window supports / Tenderliistu paigaldusjuhend.

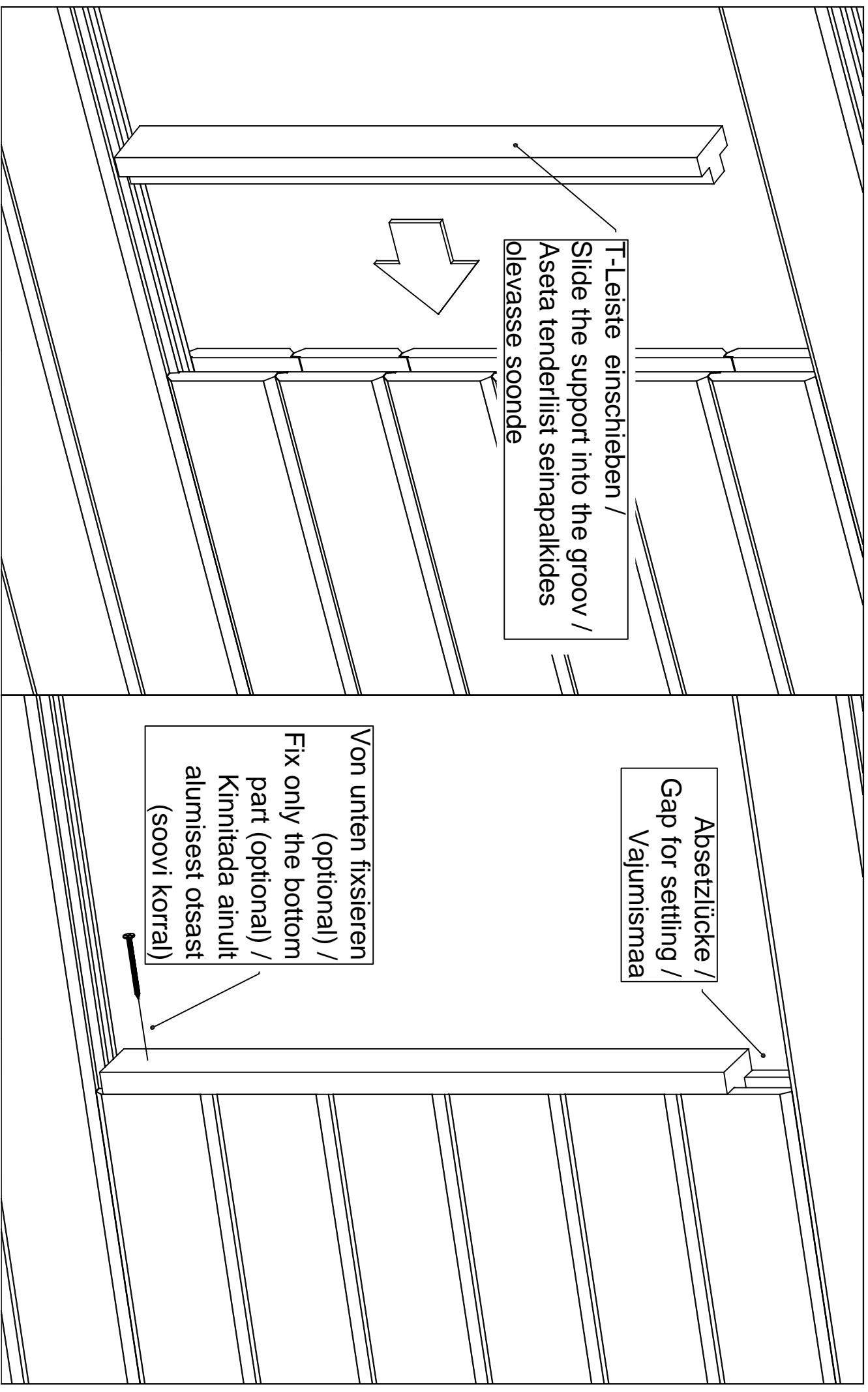

Vihmaliist / Rain strip / Wasserleiste

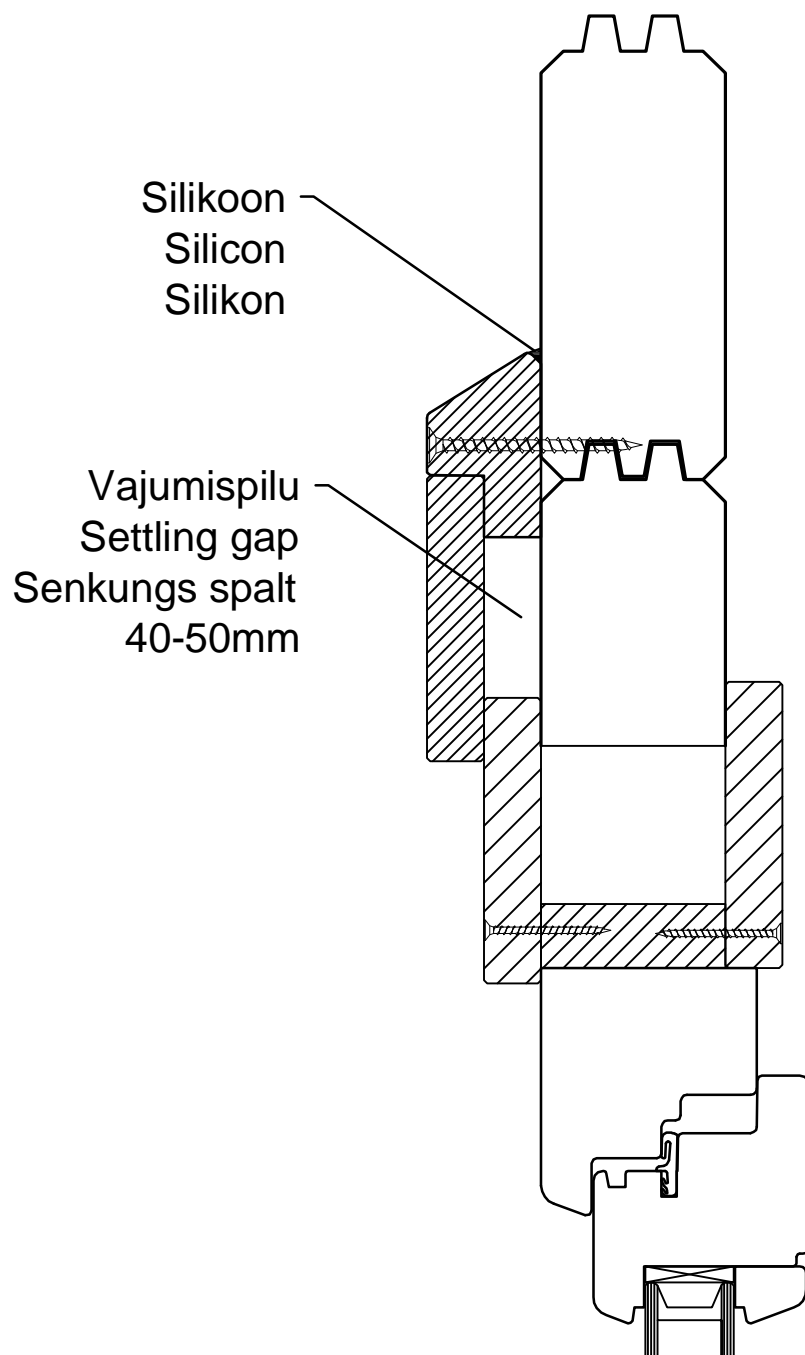

NB!

- Monteerida juhul kui ese on välja toodud maja spetsifikatsioonis!
- Install only if the item is listed in the house specification!
- Nur montieren wenn die Leiste in der Teileliste gezeigt ist!

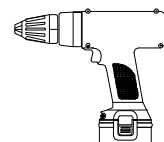

1

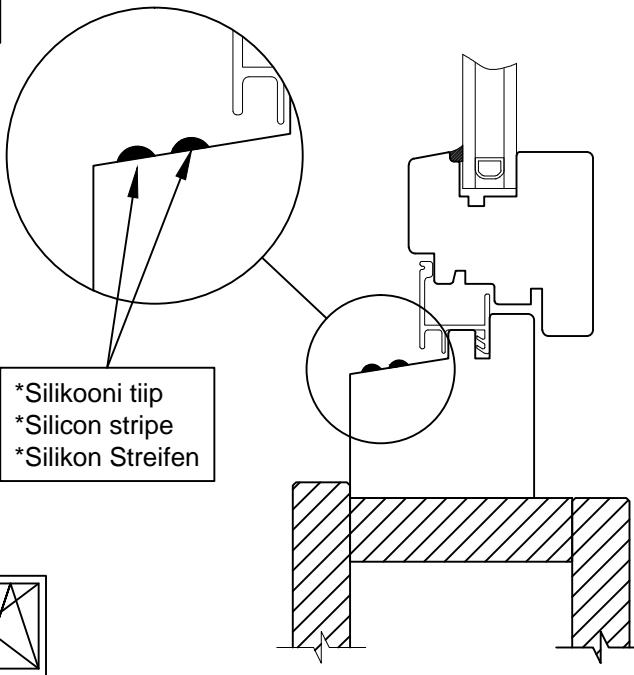

*Silikooni tiip
*Silicon stripe
*Silikon Streifen

2

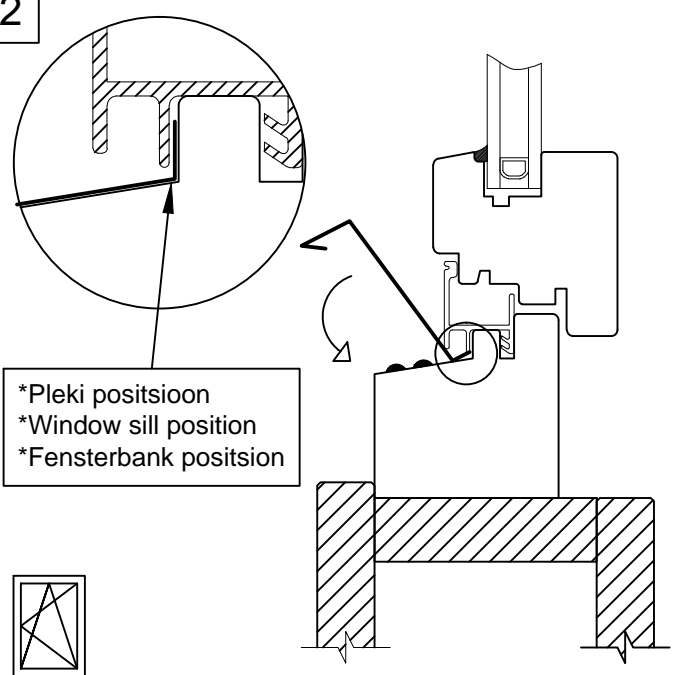

*Pleki positsioon
*Window sill position
*Fensterbank position

3

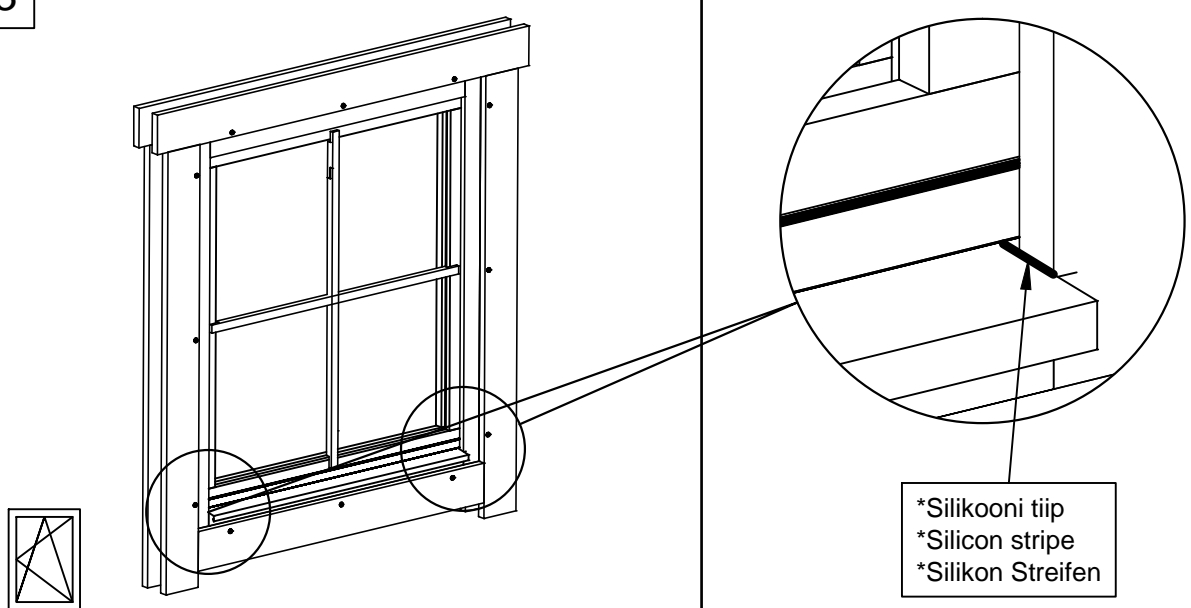

*Silikooni tiip
*Silicon stripe
*Silikon Streifen

1

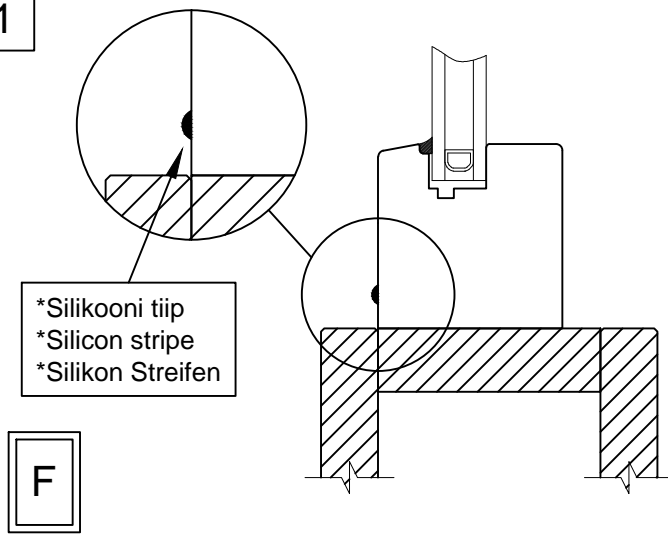

*Silikooni tiip
*Silicon stripe
*Silikon Streifen

2

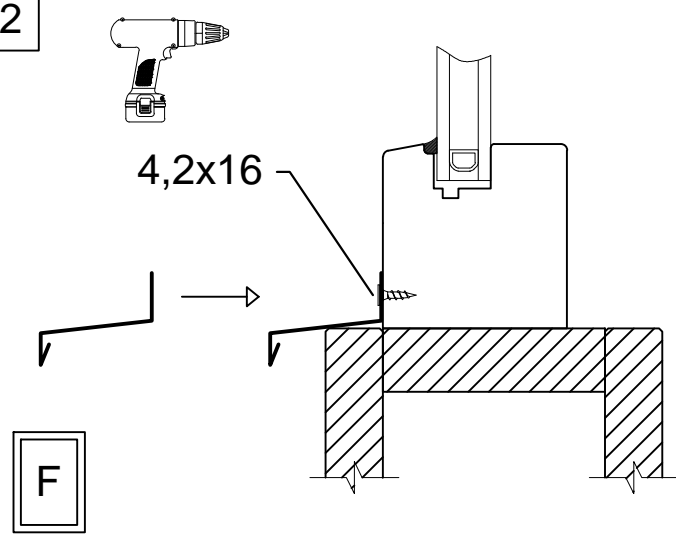

4,2x16

Aken	Q4-Q6	-	paigaldusjuhhis
Window	Q4-Q6	-	assembly instructions
Fenster	Q4-Q6	-	Montageanleitung

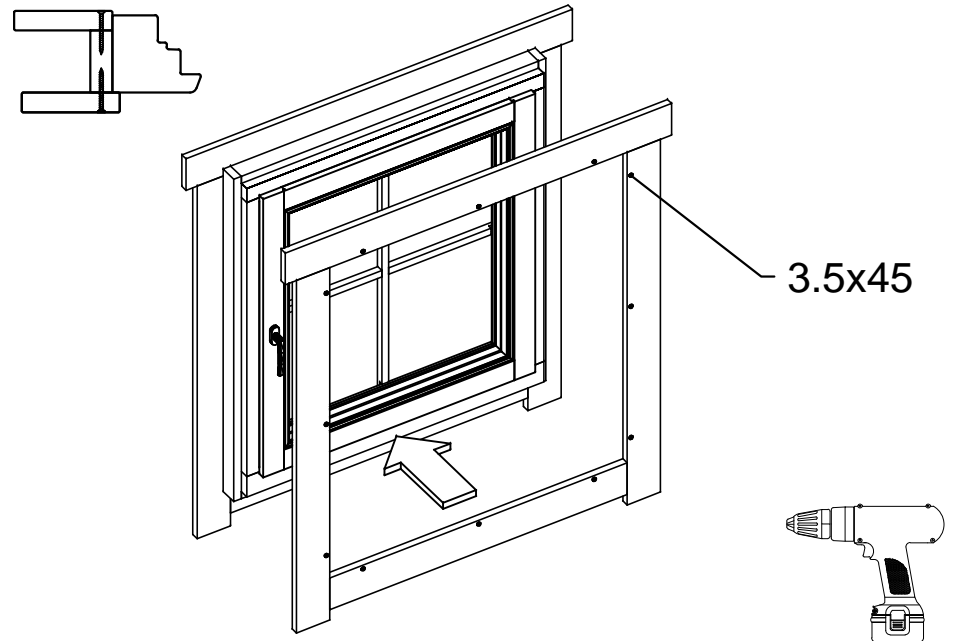
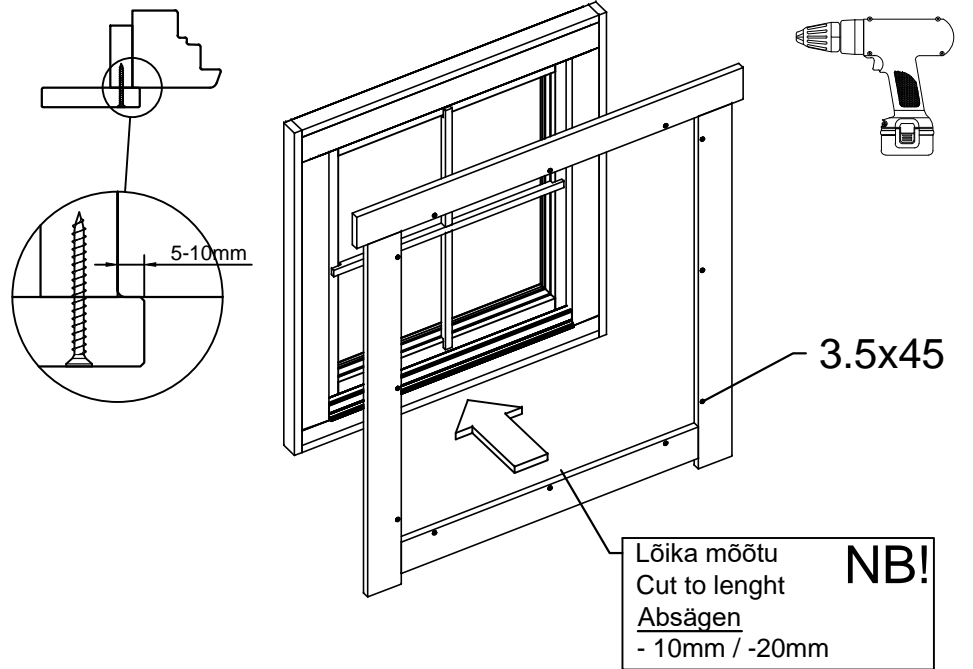
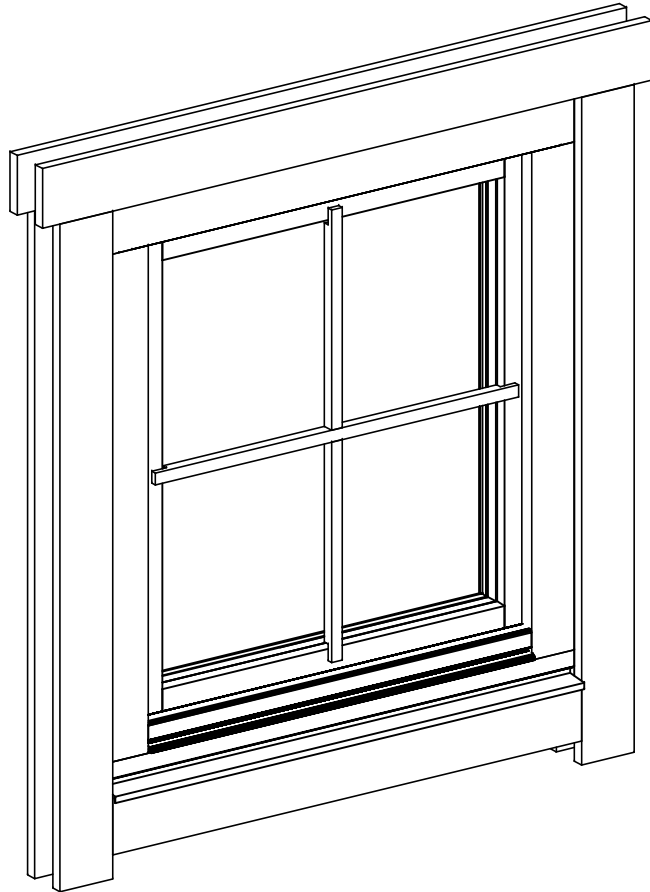

Ukse montaaž / Tür montage / Door assembly
(GH+ / SH)

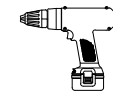
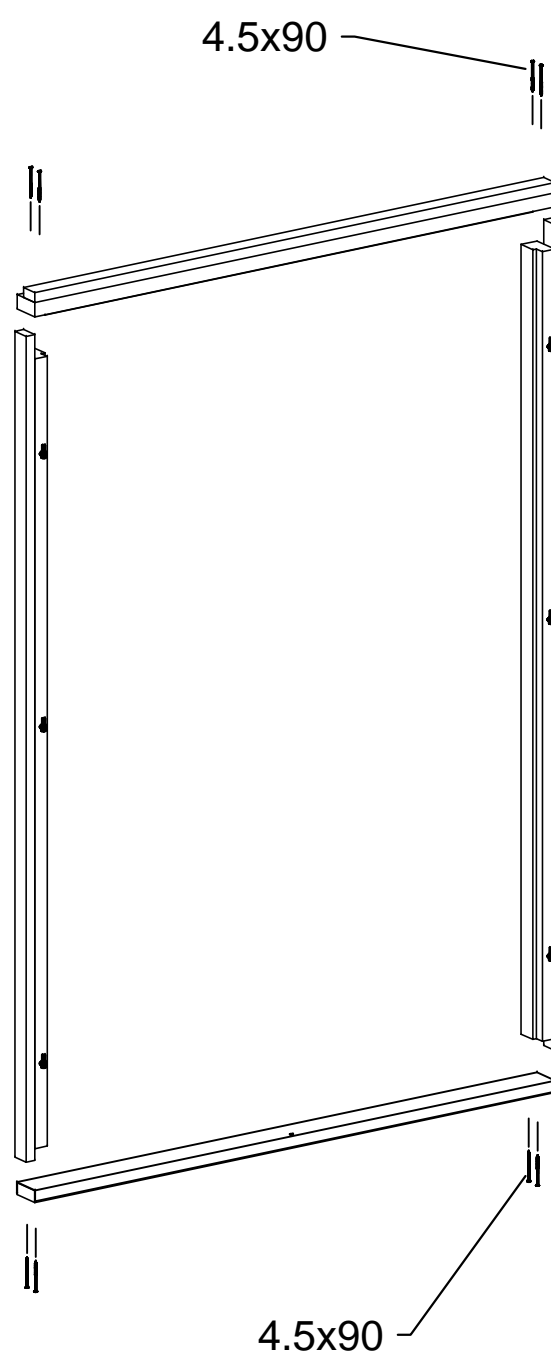
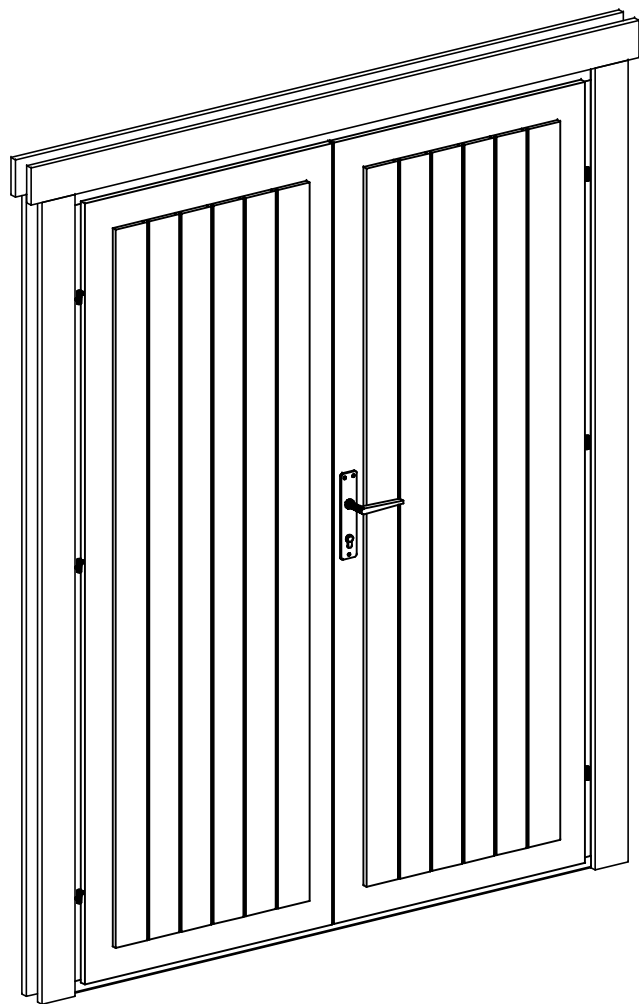

4.5x90

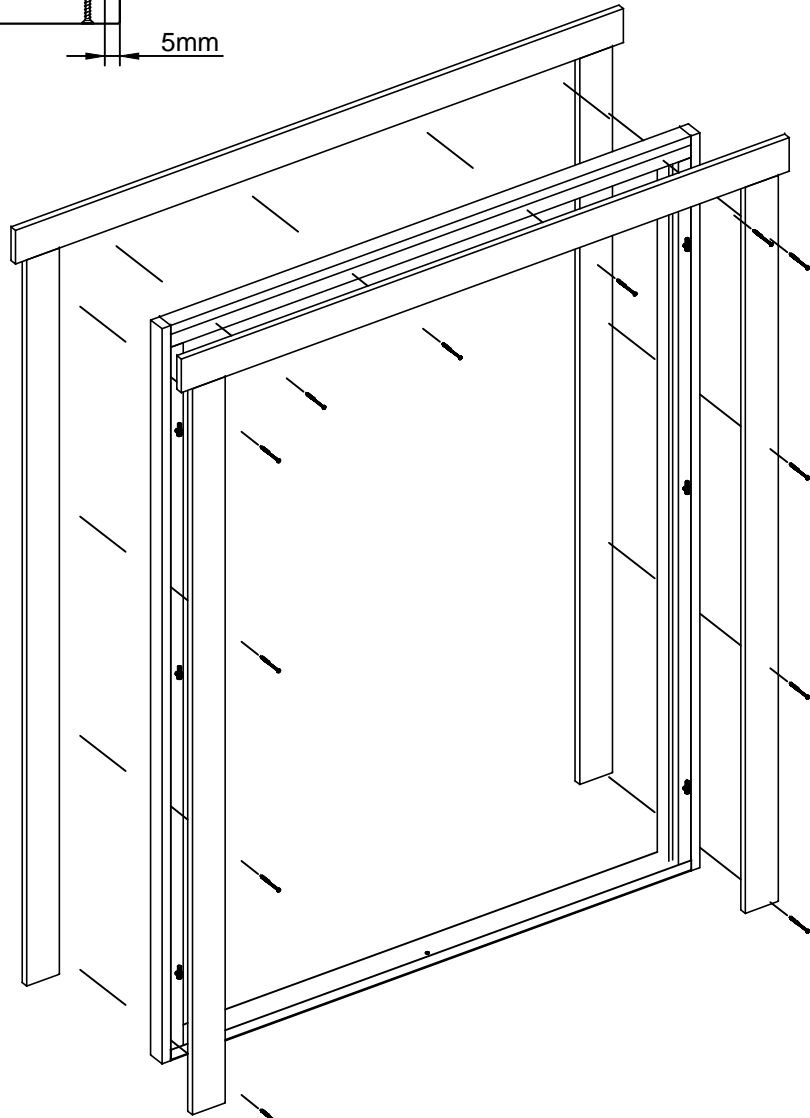
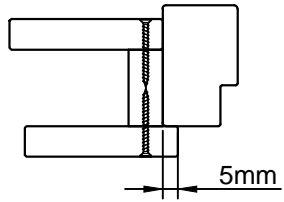

3.5x45



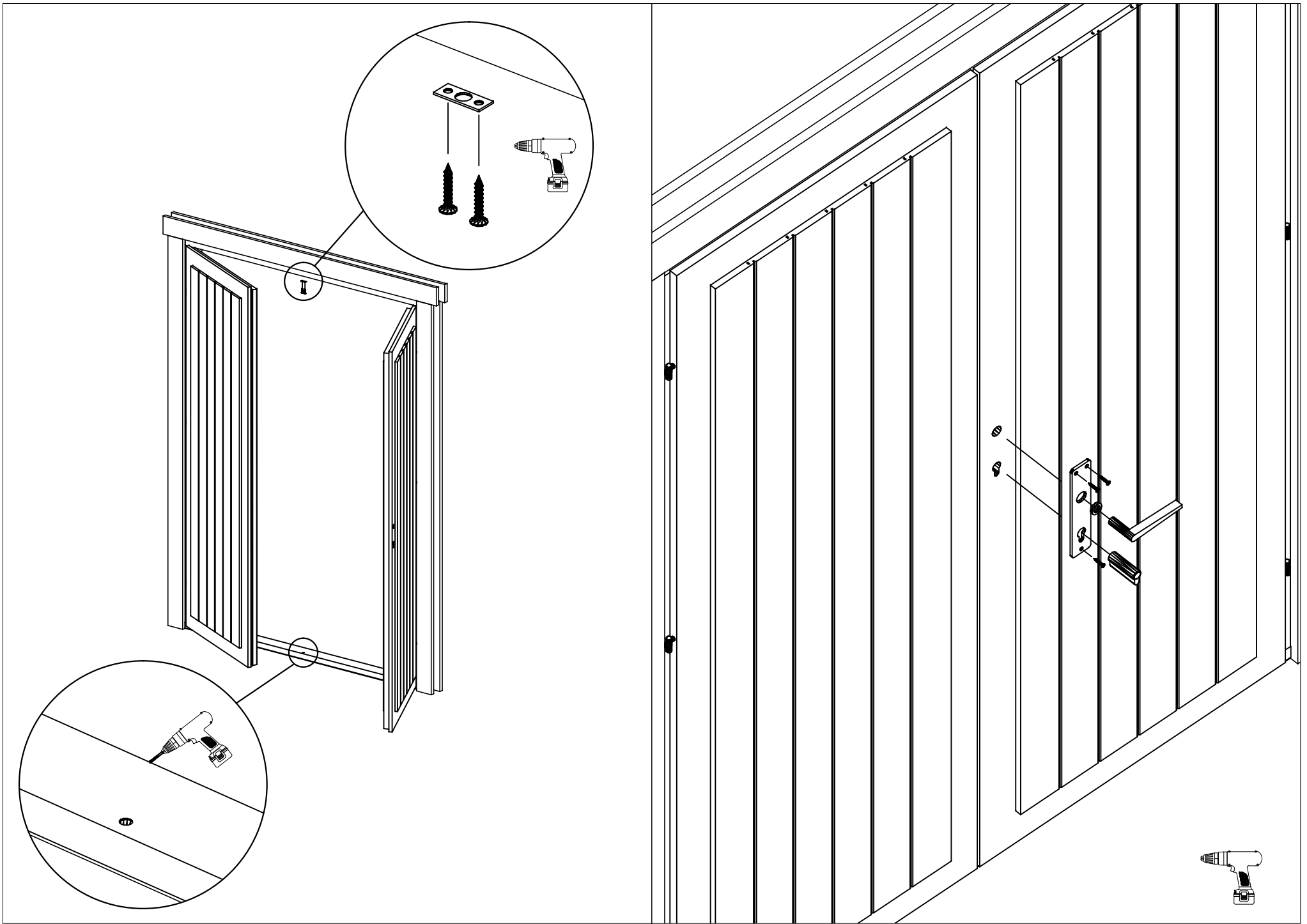

Vihmaliist / Head flashing / Regenschutz

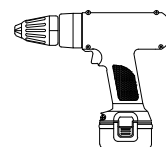
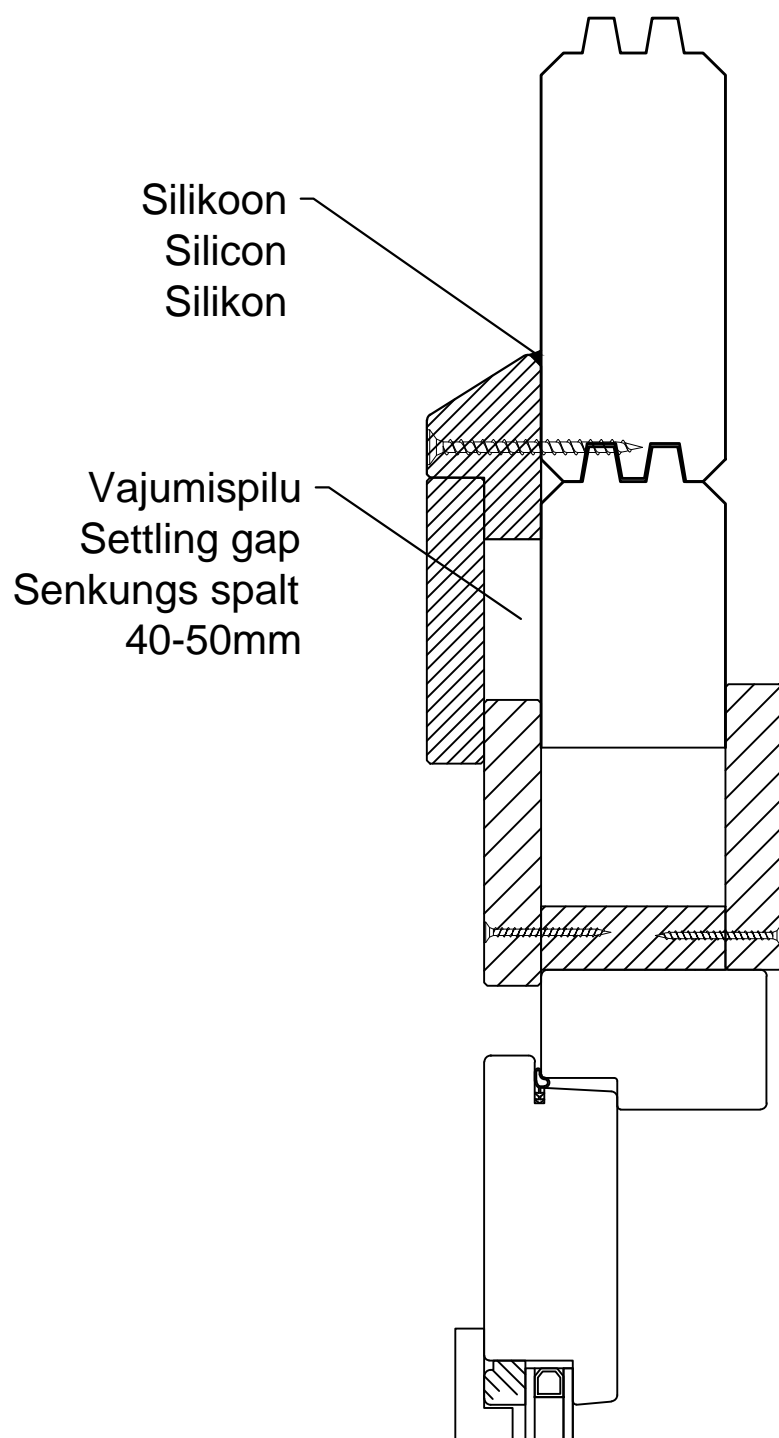

NB!

- Monteerida juhul kui ese on välja toodud maja spetsifikatsioonis!
- Install only if the item is listed in the house specification!
- Nur montieren wenn die Leiste in der Teilleiste gezeigt ist!

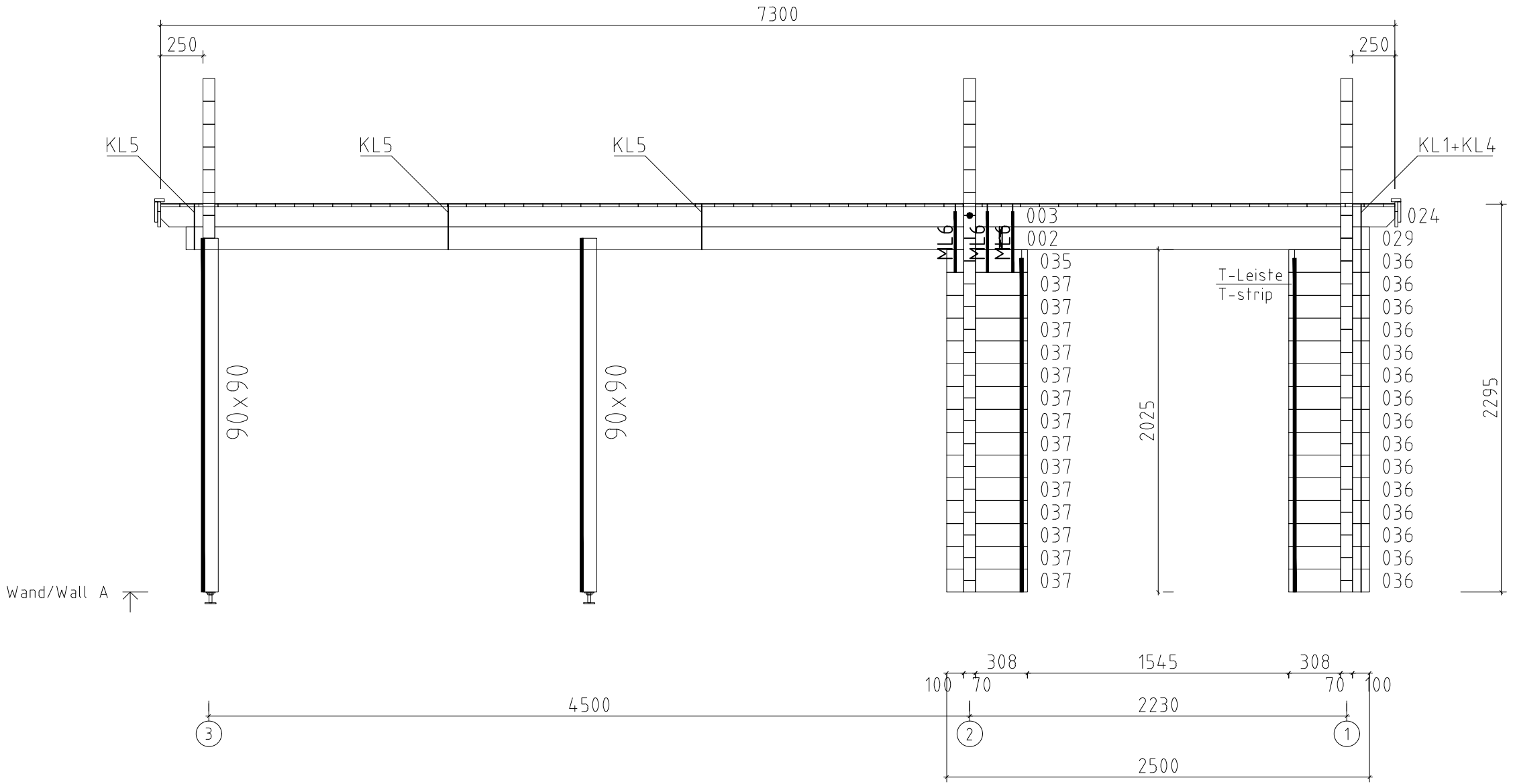
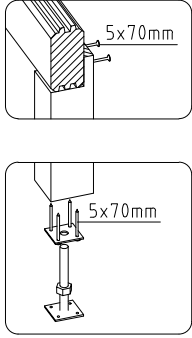

Wand/Wall A ↗

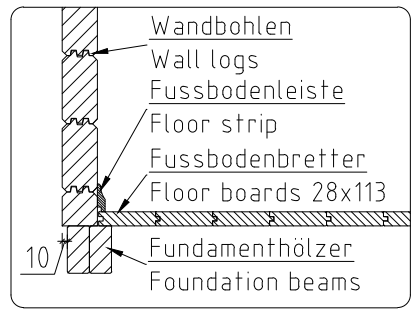

Name	Carport 350x700 70		
Zeichnung/Drawing	WAND/WALL A		
Profil/Profile	7.0x13.5	Datum/Date	16.08.2023

- Giebeldeckleisten
- Gable cover strips
- Dachbretter
- Roof boards 18x113
- Giebelleiste
- Gable strips
- Giebelbretter
- Gable boards
- Pfetten/Wandbohlen
- Purlins/Wall log

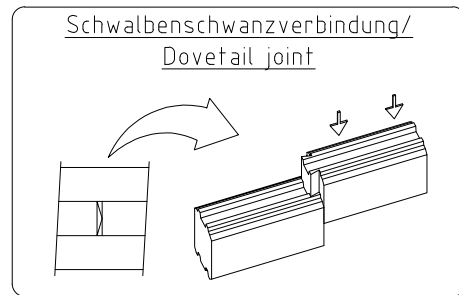
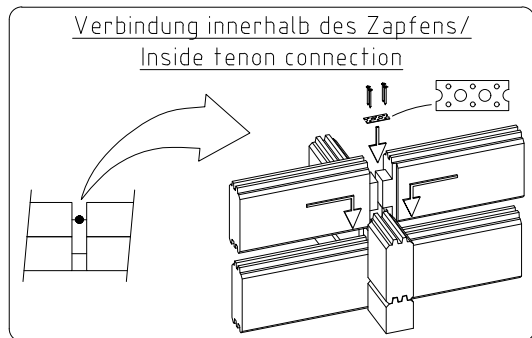
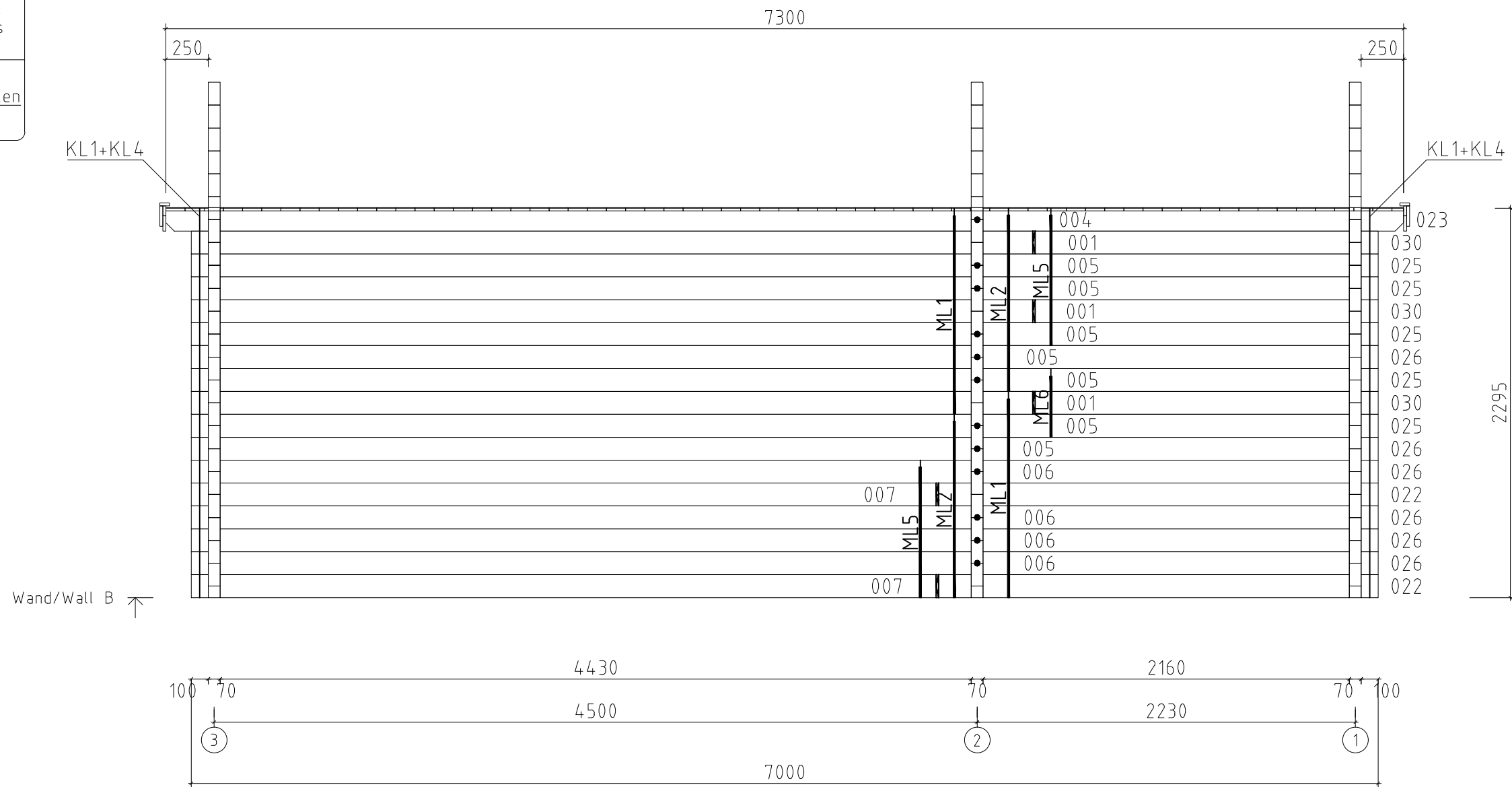

Name	Carport 350x700 70		
Zeichnung/Drawing	WAND/WALL B		
Profil/Profile	7.0x13.5	Datum/Date	16.08.2023

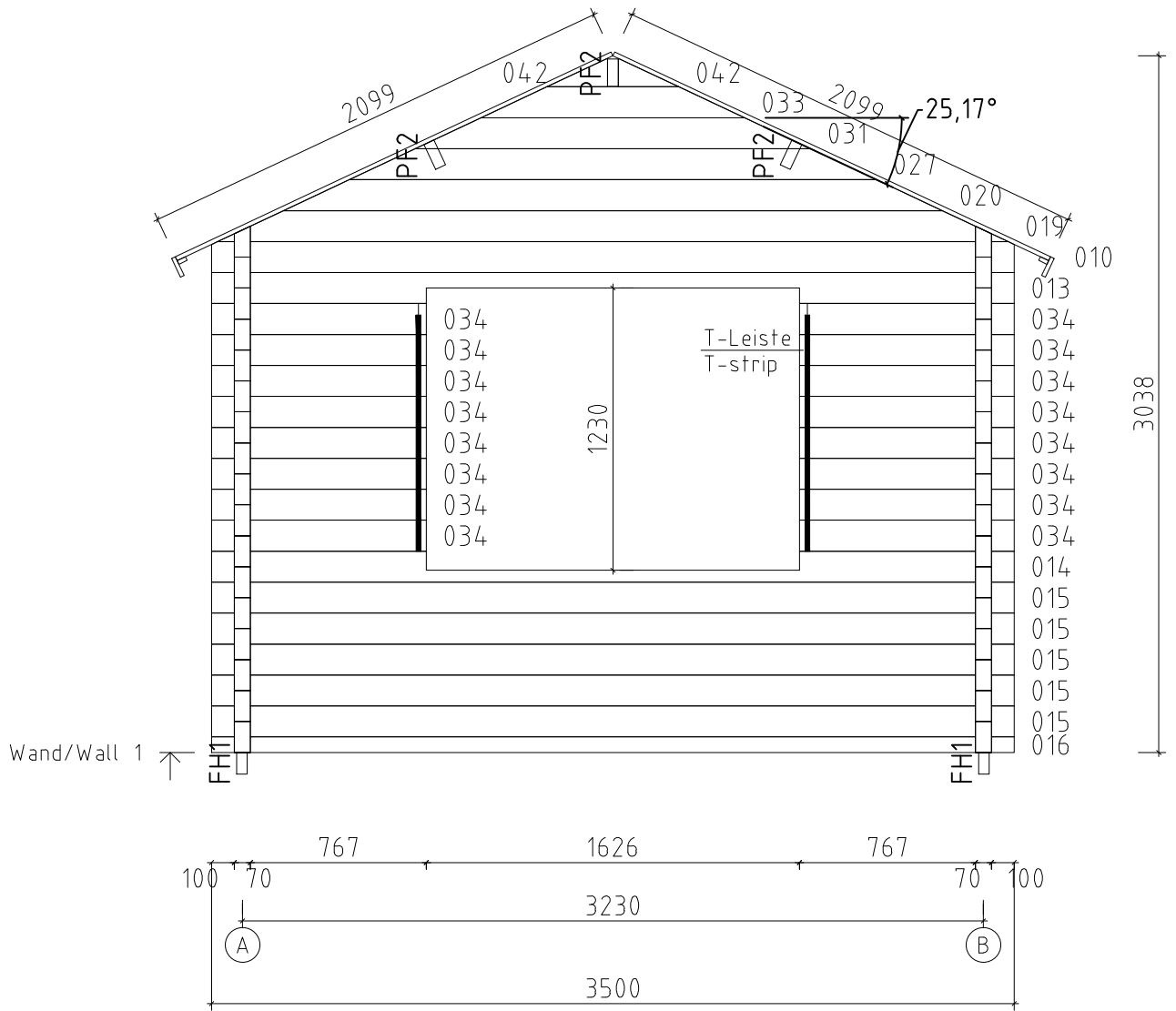

Name	Carport 350x700 70		
Zeichnung/Drawing	WAND/WALL 1		
Profil/Profile	7.0x13.5	Datum/Date	16.08.2023

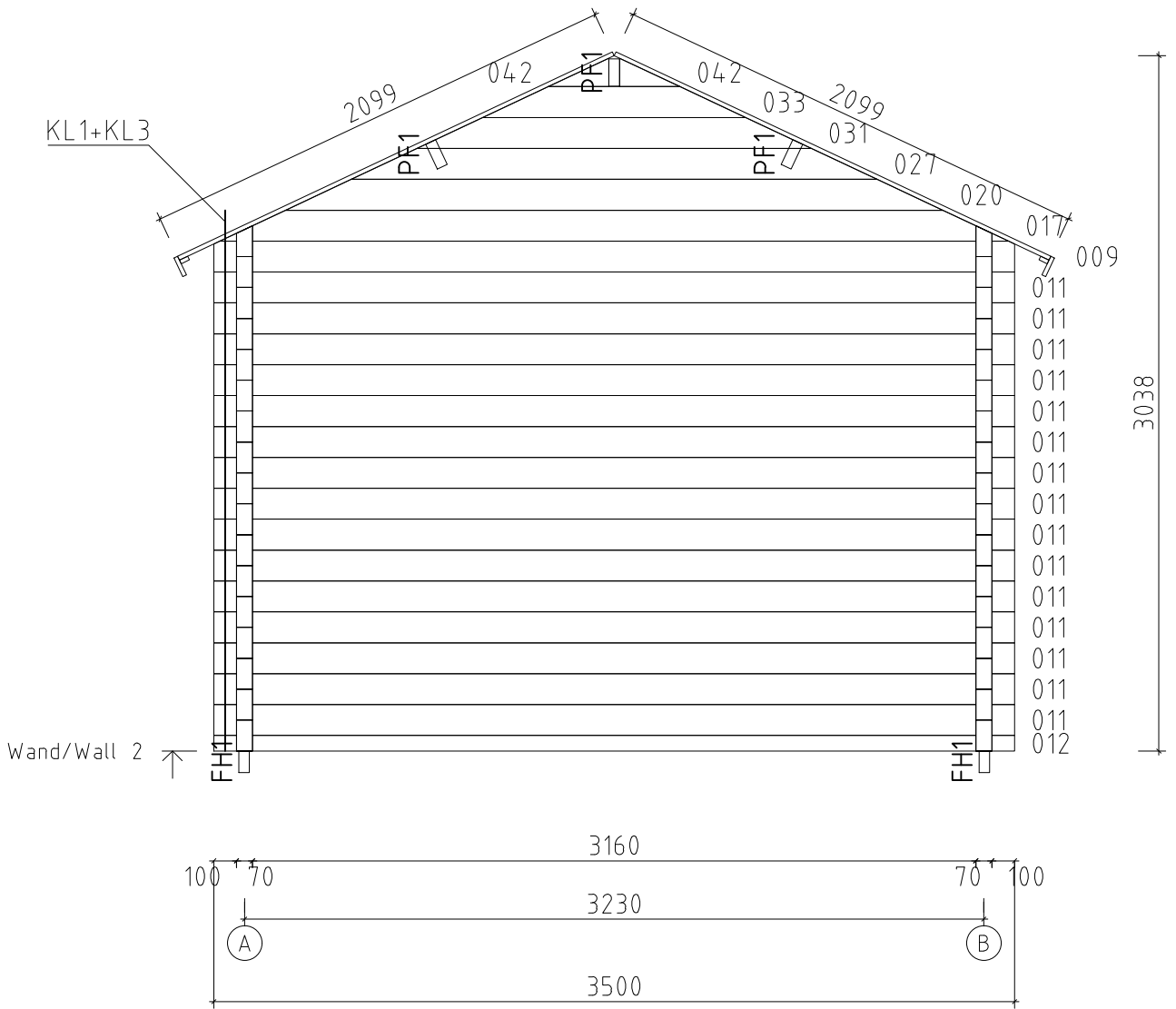

Name	Carport 350x700 70		
Zeichnung/Drawing	WAND/WALL 2		
Profil/Profile	7.0x13.5	Datum/Date	16.08.2023

Dachbretter	→
Roof boards	→
Traufenbretter	→
Gable boards	→
Traufenleisten	→
Eaves strips	→

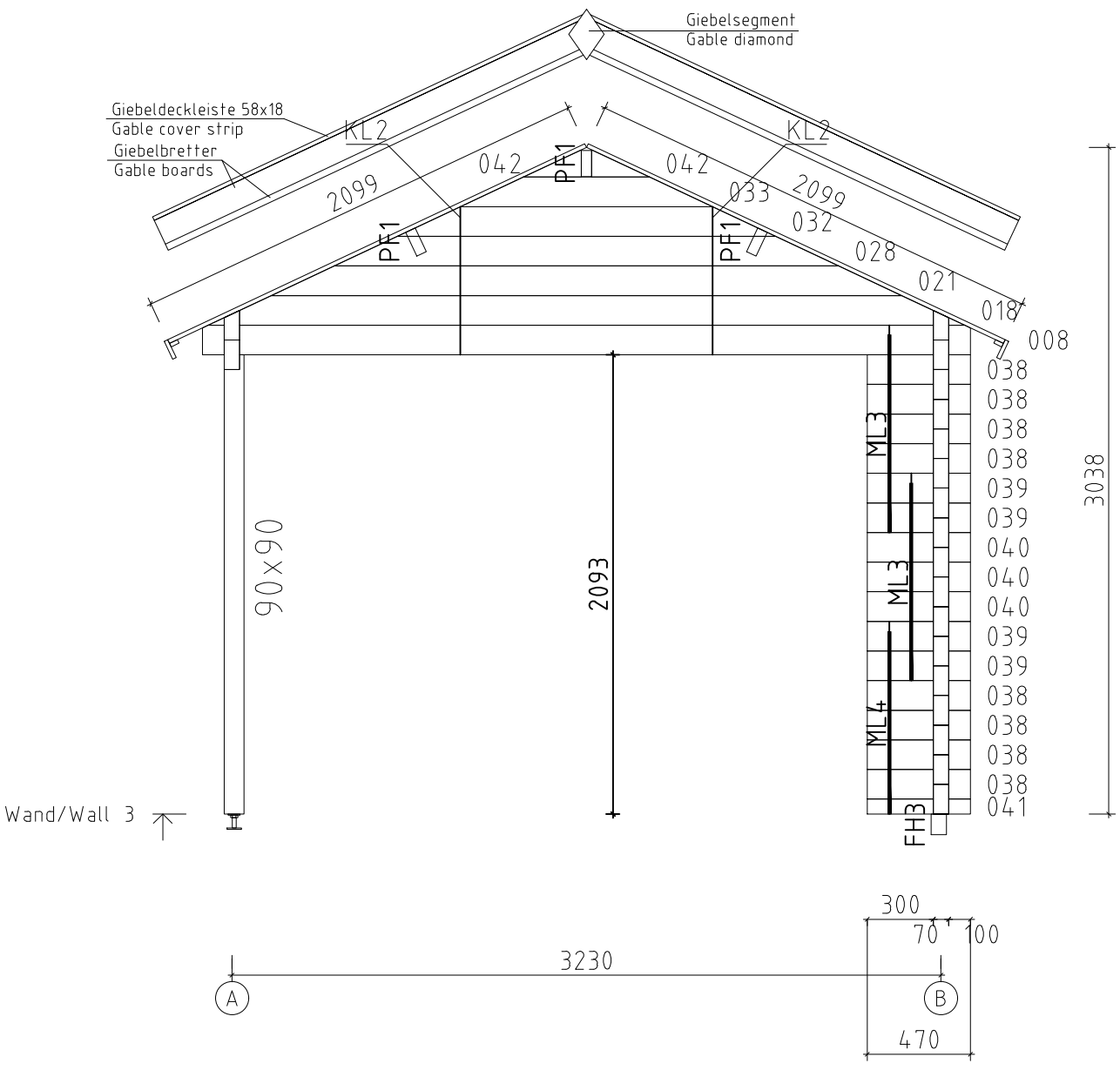

Wand/Wall 3 ↑

Name	Carport 350x700 70		
Zeichnung/Drawing	WAND/WALL 3		
Profil/Profile	7.0x13.5	Datum/Date	16.08.2023