

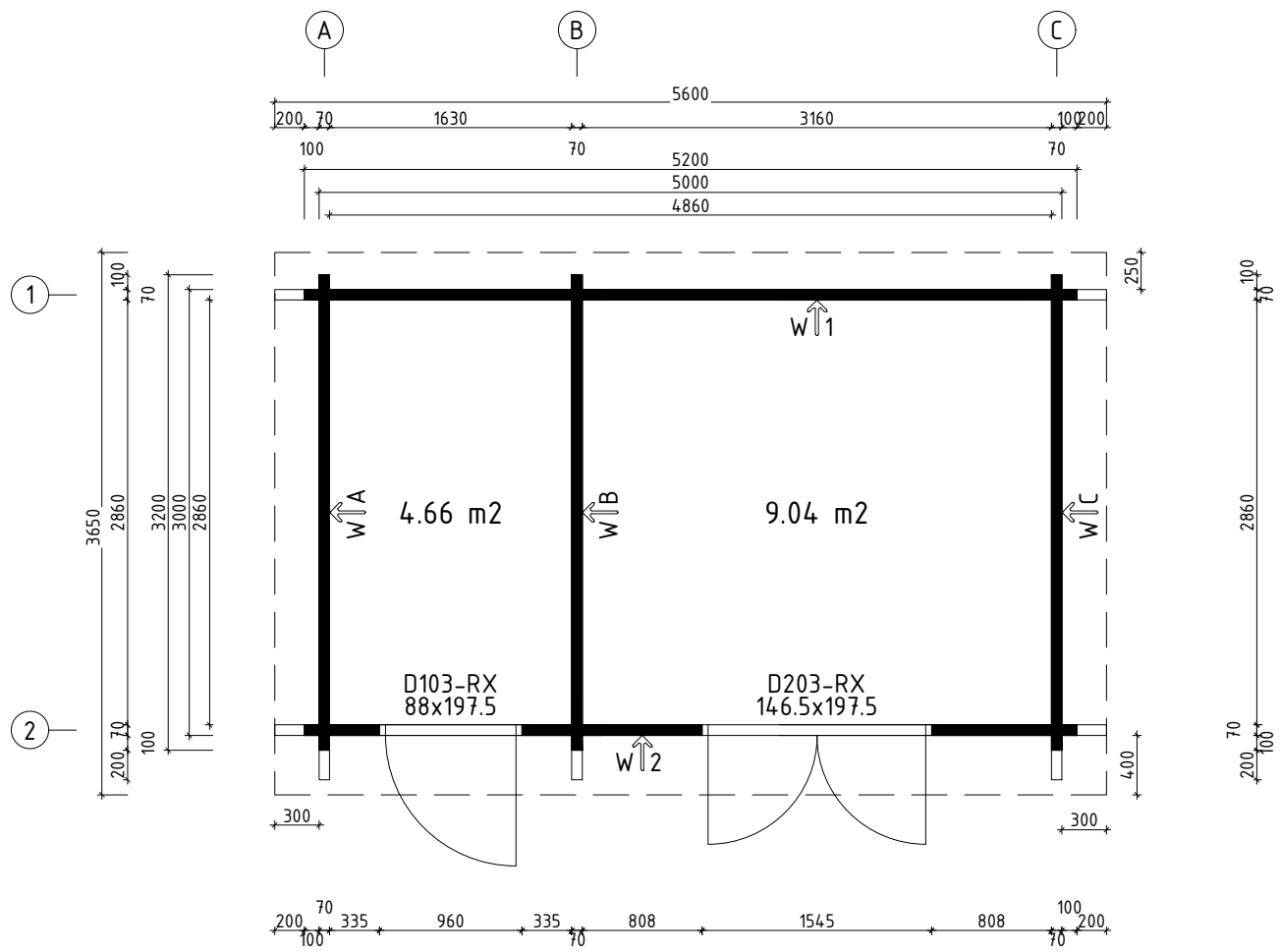









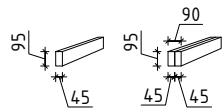
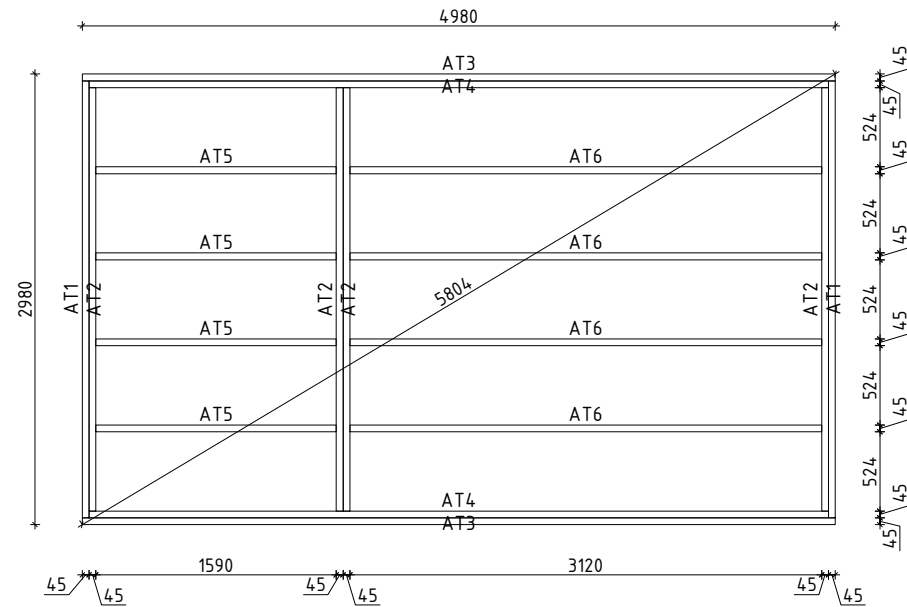

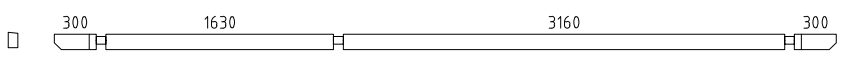

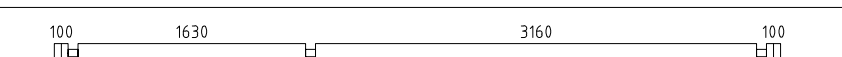

 www.hansa24.com	Name	Double Shed C mirrored 320x520 70	SKU	G0204-70-M
	Drawing/Zeichnung	3D		Format
	Profile/Profil	7.0x13.5	Scale/Maßstab	Date

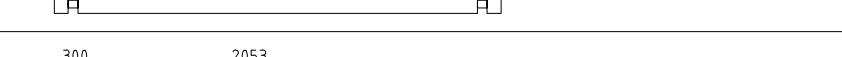
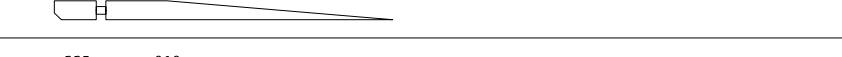



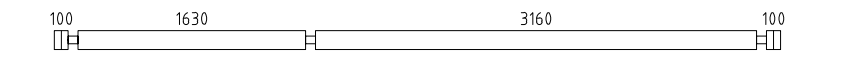
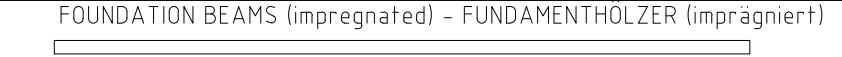
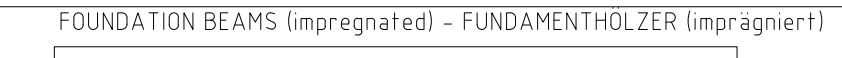
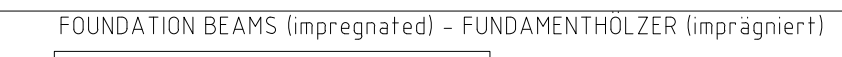
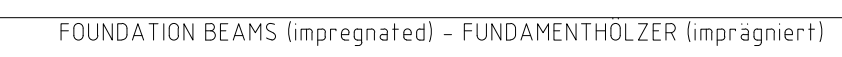
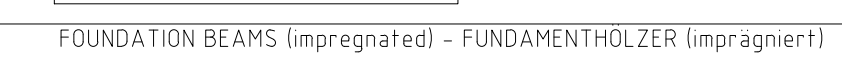
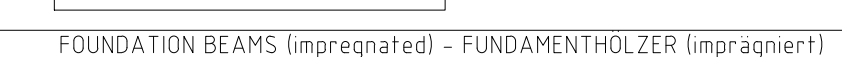
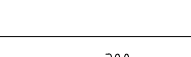



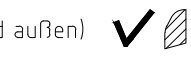



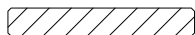

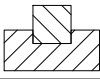
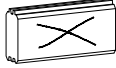

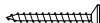

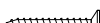



 <a href="http://www.hansa24.com">www.hansa24.com</a>	Name Double Shed C mirrored 320x520 70		SKU G0204-70-M
	Drawing/Zeichnung Plan_Grundplan		Format A4
	Profile/Profil 7.0x13.5	Scale/Maßstab 1:50	Date 12.09.2024



 <a href="http://www.hansa24.com">www.hansa24.com</a>	Name	Double Shed C mirrored 320x520 70	SKU	G0204-70-M	
	Drawing/Zeichnung	Foundation plan_Lagerholzplan	Format	A4	
	Profile/Profil	7.0x13.5	Scale/Maßstab	1:50	Date

Pos	Model Double Shed C mirrored 320x520 70	Pcs	Profile (mm)	Length (mm)
	Notice! The gable pieces can be partly pre-assembled! Please notice - those differ from the description given in the specification list.			
	Achtung! Die Giebelbohlen können teilweise schon vormontiert sein! Bitte beachten - diese erscheinen nicht ganz so wie in der Teilleiste beschrieben.			
	<b>✓</b> - Cut into length on site (if needed)! / Bitte selber anpassen (falls nötig)!			
001		1	70x110	5600
002		1	70x135	5600
003		17	70x135	5200
004		3	70x135	3200
005		3	70x68	3200
006		45	70x135	3200
007		3	70x135	2423
008		15	70x135	1213
009		15	70x135	978
010		3	70x68	808
011		15	70x135	505
Extra1		1	70x135	5200
AT3	FOUNDATION BEAMS (impregnated) - FUNDAMENTHÖLZER (imprägniert) 	2	45x95	4980
AT4	FOUNDATION BEAMS (impregnated) - FUNDAMENTHÖLZER (imprägniert) 	2	45x95	4890
AT6	FOUNDATION BEAMS (impregnated) - FUNDAMENTHÖLZER (imprägniert) 	4	45x95	3120
AT1	FOUNDATION BEAMS (impregnated) - FUNDAMENTHÖLZER (imprägniert) 	2	45x95	2890
AT2	FOUNDATION BEAMS (impregnated) - FUNDAMENTHÖLZER (imprägniert) 	4	45x95	2800
AT5	FOUNDATION BEAMS (impregnated) - FUNDAMENTHÖLZER (imprägniert) 	4	45x95	1590
PR1	PURLINS - PFETTEN 	2	70x145	5600
	ROOF BOARDS - DACHBRETTER 	50+1	113x18	3663
	FLOOR BOARDS - FUSSBODENBRETTER 	43+1	113x28	2855
	Floor mouldings - Fussbodenleisten 	<b>✓</b>	14x55	24 rm/lfm
	Ceiling mouldings - Deckenleisten (inside and outside - innen und außen) 	<b>✓</b>	15x28	39 rm/lfm
RLA 02-1	Eave board - Traufenbrett 18x120 	1	18x120	5636
RLA 01-1	Eave board - Traufenbrett 18x95 	1	18x95	5600
Kood	Double Shed C mirrored 320x520 70	Materjal	File	Leht 1/4

Pos	Model		Pcs	Profile (mm)	Length (mm)
RKL 01-1	Eave cover slat - Traufendeckleiste 18x40		1	18x40	5636
RLI01-1	Eave slat - Traufenleiste 18x40	✓ 		18x40	11.8 m/lfm
VLA 02-1	Gable board - Giebelbrett 18x120		2	18x120	3681
VKL 01-1	Gable cover slat - Giebeldeckleiste 18x40	✓ 	2	18x40	3763
	T-strip - T-Leiste 70		4		1965
LK	Hit block - Schlaghölzer		3		
N-0 2503	Nails - Nägel 2.5x60 for floor boards - für Fussbodenbretter		516		
N-0 2501	Nails - Nägel vierkant 2.5x50 for ceiling boards - für Dachbretter		400		
KR-0 3001	Screws - Schrauben 3.0x30 for ceiling mouldings - für Deckenleisten		82		
KR-0 3002	Screws - Schrauben 3.0x30 for eave slats - für Traufenleisten		24		
KR-0 3003	Screws - Schrauben 3.0x30 for floor mouldings - für Fussbodenleisten		42		
KR-0 3525	Screws - Schrauben 3.5x45 C3 for eave boards - für Traufenbretter		24		
KR-0 3526	Screws - Schrauben 3.5x45 C3 for eave cover slats - für Traufendeckleisten		12		
KR-0 3527	Screws - Schrauben 3.5x45 C3 for gable boards - für Giebelbretter		16		
KR-0 3521	Screws - Schrauben 3.5x45 C3 for gable cover slats - für Giebeldeckleisten		16		
KR-0 5080	Screws - Schrauben 5.0x100 for foundation beams - für Fundamenthölzer		72		
KL1	Threaded rod - Gewindestange M8		4		2000
KL2	Threaded rod - Gewindestange M8		2		435
KL3	Threaded rod - Gewindestange M8		2		190
	Nut - Mutter M8		4		
	Washer - Scheibe M8x24		4		
	Extended nut - Langmutter M8		4		
	Drive-in nut - Einschlagmutter M8		4		
Kood	Double Shed C mirrored 320x520 70	Materjal	File	Leht	2/4









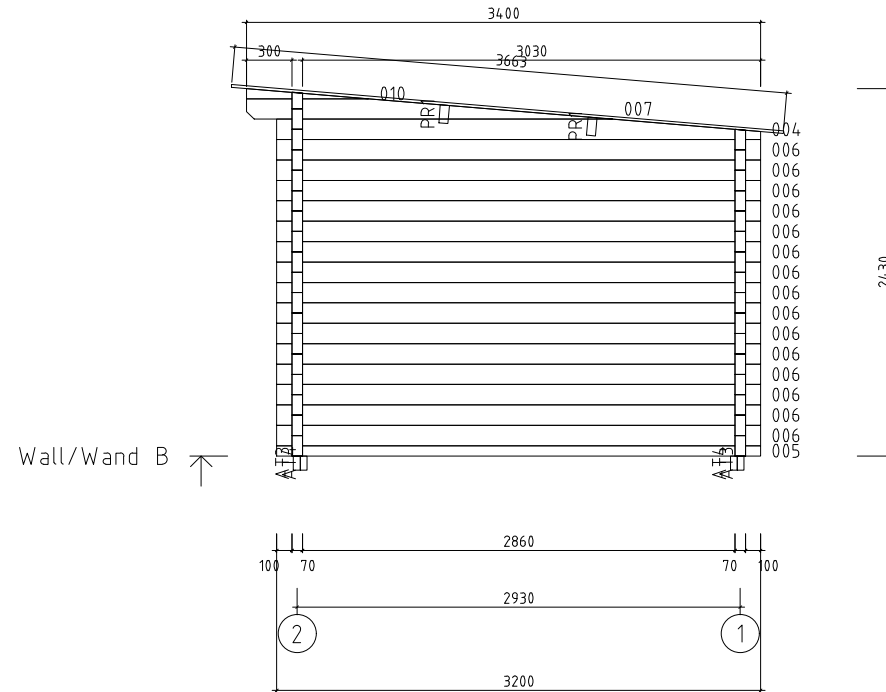



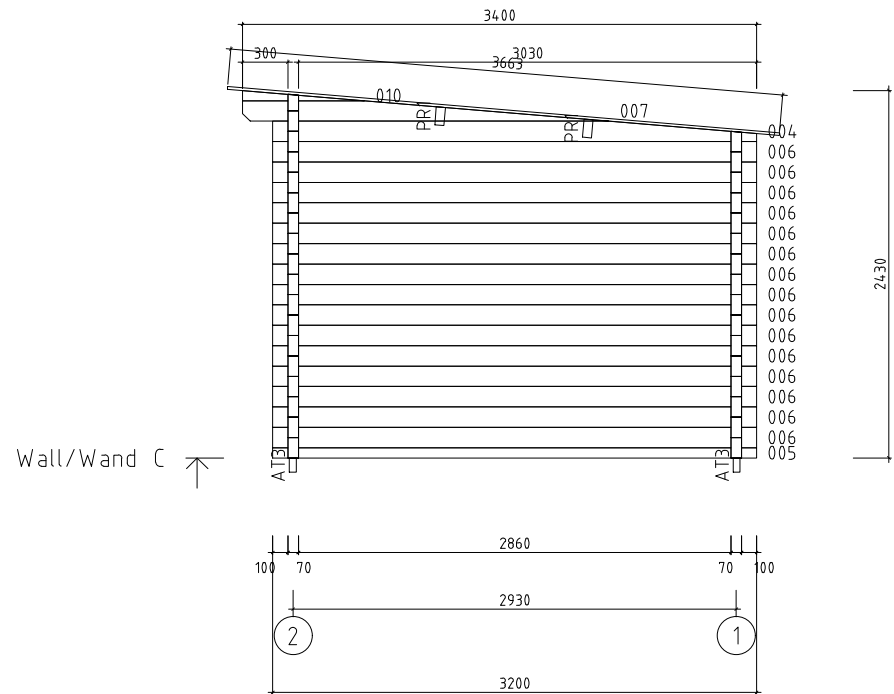

 <a href="http://www.hansa24.com">www.hansa24.com</a>	Name Double Shed C mirrored 320x520 70		SKU G0204-70-M
	Drawing/Zeichnung Wall/Wand B		Format A4
	Profile/Profil 7x13.5	Scale/Maßstab 1:50	Date 12.09.2024



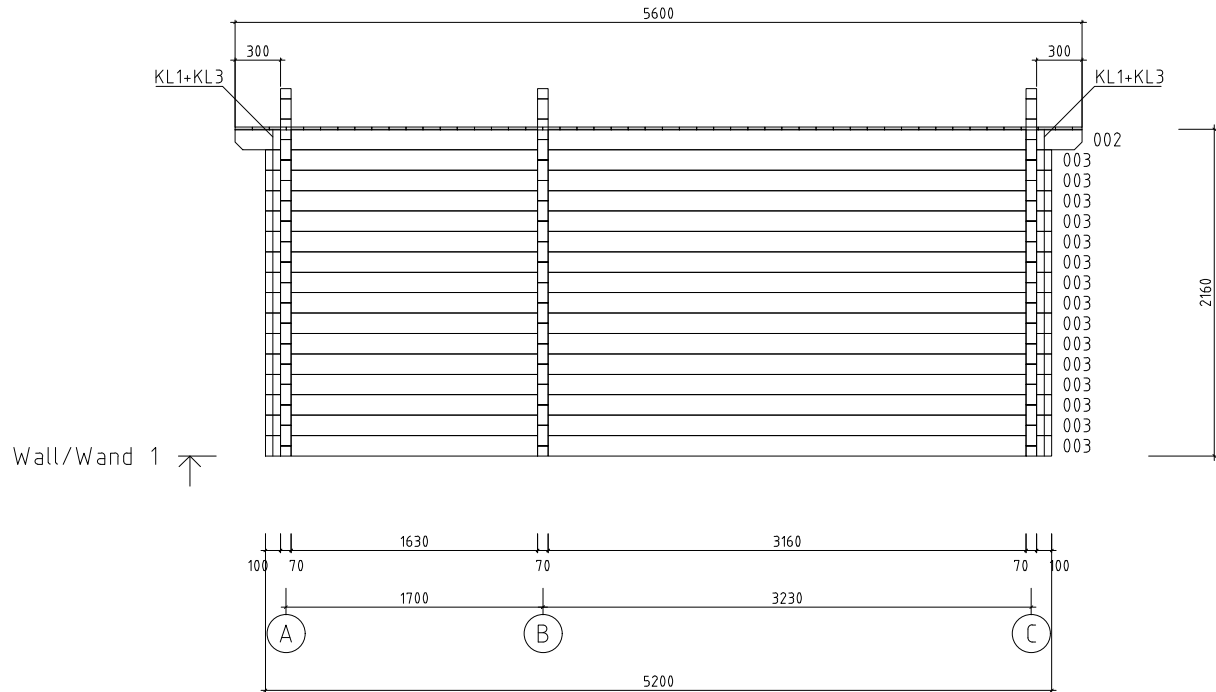

 <a href="http://www.hansa24.com">www.hansa24.com</a>	Name Double Shed C mirrored 320x520 70		SKU G0204-70-M
	Drawing/Zeichnung Wall/Wand C		Format A4
	Profile/Profil 7x13.5	Scale/Maßstab 1:50	Date 12.09.2024

- Gable cover boards  
Giebeldeckleisten
- Roof boards  
Dachbretter
- Gable boards  
Giebelbretter
- Roof beams  
Dachbalken

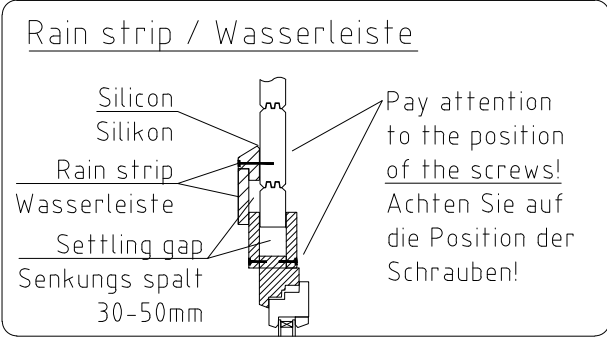
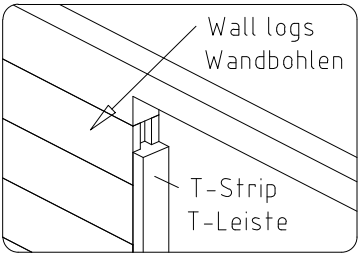
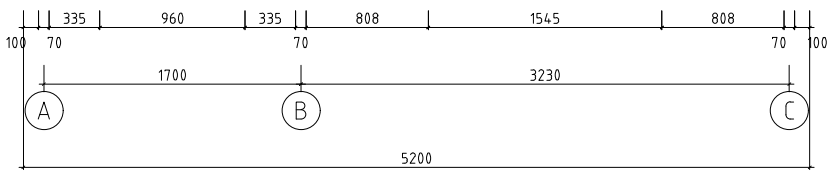
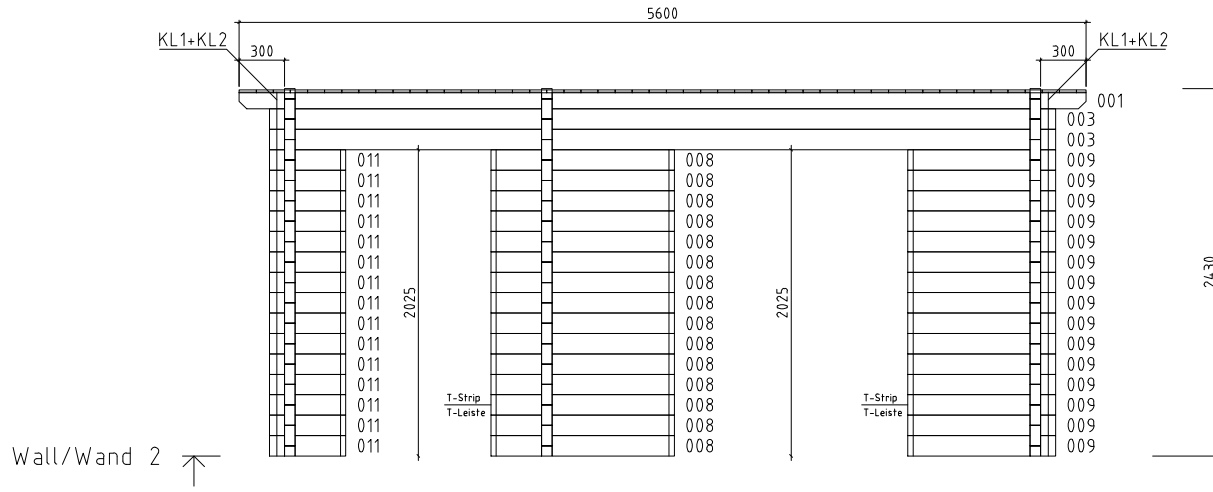

 <a href="http://www.hansa24.com">www.hansa24.com</a>	Name Double Shed C mirrored 320x520 70		SKU G0204-70-M
	Drawing/Zeichnung Wall/Wand 1		Format A4
	Profile/Profil 7x13.5	Scale/Maßstab 1:50	Date 12.09.2024



 <a href="http://www.hansa24.com">www.hansa24.com</a>	Name Double Shed C mirrored 320x520 70		SKU G0204-70-M
	Drawing/Zeichnung Wall/Wand 2		Format A4
Profile/Profil 7x13.5	Scale/Maßstab 1:50	Date 12.09.2024	